

Model 2657A High Power System SourceMeter® Instrument

User's Manual

2657A-900-01 Rev. A / April 2012



扫码二维码关注我们
或查找微信公众号：海洋仪器

Safety Precautions

The following safety precautions should be observed before using this product and any associated instrumentation. Although some instruments and accessories would normally be used with nonhazardous voltages, there are situations where hazardous conditions may be present.

This product is intended for use by qualified personnel who recognize shock hazards and are familiar with the safety precautions required to avoid possible injury. Read and follow all installation, operation, and maintenance information carefully before using the product. Refer to the user documentation for complete product specifications.

If the product is used in a manner not specified, the protection provided by the product warranty may be impaired.

The types of product users are:

Responsible body is the individual or group responsible for the use and maintenance of equipment, for ensuring that the equipment is operated within its specifications and operating limits, and for ensuring that operators are adequately trained.

Operators use the product for its intended function. They must be trained in electrical safety procedures and proper use of the instrument. They must be protected from electric shock and contact with hazardous live circuits.

Maintenance personnel perform routine procedures on the product to keep it operating properly, for example, setting the line voltage or replacing consumable materials. Maintenance procedures are described in the user documentation. The procedures explicitly state if the operator may perform them. Otherwise, they should be performed only by service personnel.

Service personnel are trained to work on live circuits, perform safe installations, and repair products. Only properly trained service personnel may perform installation and service procedures.

Keithley Instruments products are designed for use with electrical signals that are rated Measurement Category I and Measurement Category II, as described in the International Electrotechnical Commission (IEC) Standard IEC 60664. Most measurement, control, and data I/O signals are Measurement Category I and must not be directly connected to mains voltage or to voltage sources with high transient overvoltages. Measurement Category II connections require protection for high transient overvoltages often associated with local AC mains connections. Assume all measurement, control, and data I/O connections are for connection to Category I sources unless otherwise marked or described in the user documentation.

Exercise extreme caution when a shock hazard is present. Lethal voltage may be present on cable connector jacks or test fixtures. The American National Standards Institute (ANSI) states that a shock hazard exists when voltage levels greater than 30 V RMS, 42.4 V peak, or 60 VDC are present. A good safety practice is to expect that hazardous voltage is present in any unknown circuit before measuring.

Operators of this product must be protected from electric shock at all times. The responsible body must ensure that operators are prevented access and/or insulated from every connection point. In some cases, connections must be exposed to potential human contact. Product operators in these circumstances must be trained to protect themselves from the risk of electric shock. If the circuit is capable of operating at or above 1000 V, no conductive part of the circuit may be exposed.

Do not connect switching cards directly to unlimited power circuits. They are intended to be used with impedance-limited sources. NEVER connect switching cards directly to AC mains. When connecting sources to switching cards, install protective devices to limit fault current and voltage to the card.

Before operating an instrument, ensure that the line cord is connected to a properly-grounded power receptacle. Inspect the connecting cables, test leads, and jumpers for possible wear, cracks, or breaks before each use.

When installing equipment where access to the main power cord is restricted, such as rack mounting, a separate main input power disconnect device must be provided in close proximity to the equipment and within easy reach of the operator.

For maximum safety, do not touch the product, test cables, or any other instruments while power is applied to the circuit under test. ALWAYS remove power from the entire test system and discharge any capacitors before: connecting or disconnecting cables or jumpers, installing or removing switching cards, or making internal changes, such as installing or removing jumpers.

Do not touch any object that could provide a current path to the common side of the circuit under test or power line (earth) ground. Always make measurements with dry hands while standing on a dry, insulated surface capable of withstanding the voltage being measured.

The instrument and accessories must be used in accordance with its specifications and operating instructions, or the safety of the equipment may be impaired.

Do not exceed the maximum signal levels of the instruments and accessories, as defined in the specifications and operating information, and as shown on the instrument or test fixture panels, or switching card.

When fuses are used in a product, replace with the same type and rating for continued protection against fire hazard.

Chassis connections must only be used as shield connections for measuring circuits, NOT as safety earth ground connections.

If you are using a test fixture, keep the lid closed while power is applied to the device under test. Safe operation requires the use of a lid interlock.

If a  screw is present, connect it to safety earth ground using the wire recommended in the user documentation.

The  symbol on an instrument means caution, risk of danger. The user should refer to the operating instructions located in the user documentation in all cases where the symbol is marked on the instrument.

The  symbol on an instrument means caution, risk of electric shock. Use standard safety precautions to avoid personal contact with these voltages.

The  symbol on an instrument shows that the surface may be hot. Avoid personal contact to prevent burns.

The  symbol indicates a connection terminal to the equipment frame.

If this  symbol is on a product, it indicates that mercury is present in the display lamp. Please note that the lamp must be properly disposed of according to federal, state, and local laws.

The **WARNING** heading in the user documentation explains dangers that might result in personal injury or death. Always read the associated information very carefully before performing the indicated procedure.

The **CAUTION** heading in the user documentation explains hazards that could damage the instrument. Such damage may invalidate the warranty.

Instrumentation and accessories shall not be connected to humans.

Before performing any maintenance, disconnect the line cord and all test cables.

To maintain protection from electric shock and fire, replacement components in mains circuits — including the power transformer, test leads, and input jacks — must be purchased from Keithley Instruments. Standard fuses with applicable national safety approvals may be used if the rating and type are the same. Other components that are not safety-related may be purchased from other suppliers as long as they are equivalent to the original component (note that selected parts should be purchased only through Keithley Instruments to maintain accuracy and functionality of the product). If you are unsure about the applicability of a replacement component, call a Keithley Instruments office for information.

To clean an instrument, use a damp cloth or mild, water-based cleaner. Clean the exterior of the instrument only. Do not apply cleaner directly to the instrument or allow liquids to enter or spill on the instrument. Products that consist of a circuit board with no case or chassis (e.g., a data acquisition board for installation into a computer) should never require cleaning if handled according to instructions. If the board becomes contaminated and operation is affected, the board should be returned to the factory for proper cleaning/servicing.

Table of Contents

Introduction	1-1
Welcome	1-1
Extended warranty	1-1
Introduction to this manual	1-1
CD-ROM contents	1-2
Organization of manual sections	1-3
Applications	1-3
Safe configuration and test setup	2-1
Introduction	2-1
Using the Model 2657A with the Model 8010 test fixture	2-1
Using the Model 2657A in a custom test fixture or system	2-3
Connecting the interlock of the Model 2657A	2-3
Connecting the Model 2657A output to a custom test fixture	2-4
Four-wire connections to a test fixture with HV triaxial connectors	2-9
Using the front-panel interface	3-1
Introduction	3-1
Front panel	3-2
Placing a Model 2657A in standby	3-4
Changing values from the front panel	3-4
Using the web interface	4-1
Introduction	4-1
Connecting to the instrument web interface	4-1
Web interface home page	4-2
IP configuration tab	4-3
TSB Embedded	4-4
Create a script using TSB Embedded	4-4
Exercise: Create and run a script with TSB Embedded	4-4
Reading buffers	4-7
Exercise: Retrieve readings from a buffer	4-7
TSP Express	4-9
Making basic front-panel measurements	5-1
Introduction	5-1
Equipment needed for this example	5-1
Device connections	5-2

Making front-panel measurements	5-4
Procedure for making front-panel measurements	5-4
Measuring diode off-state breakdown	6-1
Introduction	6-1
Equipment required	6-1
Set up communication	6-2
Device connections	6-3
Simple reverse voltage sweep	6-5
Example code	6-5
Example usage	6-8
Advanced reverse voltage sweep	6-9
Example code	6-9
Example usage	6-12
Measuring capacitor leakage	7-1
Introduction	7-1
Equipment required	7-1
Set up communication	7-2
Device connections	7-2
Measuring leakage current and insulation resistance	7-4
Example code	7-4
Example usage	7-6
Measuring MOSFET characteristics	8-1
Introduction	8-1
Equipment required	8-1
Set up communication	8-2
Device connections	8-3
BV _{dss} measurement	8-6
Example code	8-7
Example usage	8-8
I _{dss} measurement	8-9
Example code	8-9
Example usage	8-11
Measuring thyristor DC characteristics	9-1
Introduction	9-1
Equipment required for this example	9-1
Set up communication	9-2
Device connections	9-3

V _{drm} and I _{drm} thyristor measurements.....	9-6
Example code	9-6
Example usage	9-8
Determine the holding current of a thyristor.....	9-10
Example code	9-10
Example usage	9-12
Determine the latching current of a thyristor.....	9-12
Example code	9-13
Example usage	9-15
Troubleshooting FAQs	10-1
About this section.....	10-1
How do I change the line frequency or voltage?.....	10-1
Where can I find updated drivers?	10-2
Can I convert to coaxial cables?	10-2
How do I connect LO terminals of multiple SMUs together?	10-2
What should I do if I get an 802 interlock error?	10-3
Why is the reading value 9.91e37?.....	10-3
Why is the reading value 9.92e37?.....	10-3
Next steps.....	11-1
Additional Model 2657A information	11-1
Index	Index-1

Introduction

In this section:

Welcome	1-1
Extended warranty	1-1
Introduction to this manual	1-1
CD-ROM contents.....	1-2
Organization of manual sections	1-3
Applications.....	1-3

Welcome

Thank you for choosing a Keithley Instruments product. The Model 2657A High Power System SourceMeter[®] Instrument provides manufacturers of electronic components and semiconductor devices with an instrument that combines source and measurement capabilities in a single instrument called a source-measure unit (also called a SMU). This combination simplifies test processes by eliminating synchronization and connection issues associated with multiple instrument solutions. A Model 2657A provides a scalable, high throughput, highly cost-effective solution for precision DC, pulse, and high voltage source-measure testing that also maintains code compatibility with the Series 2600A instruments.

Extended warranty

Additional years of warranty coverage are available on many products. These valuable contracts protect you from unbudgeted service expenses and provide additional years of protection at a fraction of the price of a repair. Extended warranties are available on new and existing products. Contact your local Keithley Instruments representative for details.

Introduction to this manual

This manual provides detailed tutorials to help you achieve success with your Keithley Instruments Model 2657A High Power System SourceMeter[®] Instrument. In addition, this manual provides the basics of the two simplest Model 2657A interfaces, the front panel and the web interface, to familiarize you with the instrument. You can also familiarize yourself with the instrument by running the examples in this manual that are relevant to your intended use and to the equipment you are using.

Some of the examples in this manual may use unfamiliar commands and concepts. For detailed information about these, refer to the Reference Manual (part number 2657A-901-01) on the Product Information CD-ROM that came with your instrument.

CD-ROM contents

Two CD-ROMs are shipped with each Series 2650A instrument:

- The Series 2650A Product Information CD-ROM (Keithley Instruments part number 2650AS-950-01)
- Test Script Builder Integrated Development Environment CD-ROM (Keithley Instruments part number KTS-850)

The Series 2650A Product Information CD-ROM contains:

- **Quick Start Guide:** Provides unpacking instructions, describes basic connections, and reviews basic operation information. If you are new to Keithley Instruments equipment, refer to the Quick Start Guide to take the steps needed to unpack, set up, and verify operation.
- **User's Manual:** Provides application examples. If you need a starting point to begin creation of applications, refer to the User's Manual for a variety of specific examples.
- **Reference Manual:** Includes advanced operation topics and maintenance information. Programmers looking for a command reference, and users looking for an in-depth description of the way the instrument works (including troubleshooting and optimization), should refer to the Reference Manual.
- **Model 8010 High Power Test Fixture Interconnection Reference Guide:** A quick reference for making typical test connections using the optional Model 8010 test fixture.
- **Model 8010 High Power Test Fixture User's Manual:** Provides complete connection information and sample applications for the optional Model 8010 test fixture.
- **Accessories information:** Documentation for available accessories.
- **Model 2657A TSB Add-in:** Additional tools for the Test Script Builder Integrated Development Environment (TSB), including Model 2657A-specific examples and help files.
- **Drivers and release notes:** IVI Instrument Driver, National Instruments LabVIEW™ driver, and related release notes.
- **J2SE™ Runtime Environment:** Web browser plug-in that is required to run the web applications that are available through the instrument web interface.
- **Keithley I/O layer and release notes:** The Keithley I/O layer manages communications between Keithley Instruments drivers and software applications and the Model 2657A.
- **Keithley LXI Discovery Browser:** Identifies the IP addresses of instruments connected to the local area network (LAN) that support VXI-11 discovery protocol.

For the latest drivers and additional support information, see the [Keithley Instruments website](#)

The Test Script Builder Integrated Development Environment CD-ROM contains:

- The installation files for the Test Script Builder Integrated Development Environment. This software provides an environment in which you can develop a test program and the ability to load the test program onto the instrument. Running a program that is loaded on the instrument eliminates the need to send individual commands from the host computer to the instrument when running a test.

Organization of manual sections

This manual is organized into the following sections:

- [Safe configuration and test setup](#) (on page 2-1): Describes how to use the Model 2657A with the optional Keithley Instruments Model 8010 High Power Device Test Fixture or a custom test fixture or system.
- [Using the front-panel interface](#) (on page 3-1): Describes the basics of using the front-panel interface.
- [Using the web interface](#) (on page 4-1): Describes the basics of using the web interface.
- **Applications** (described below) that provide detailed examples of how to use the Model 2657A.
- [Troubleshooting FAQs](#) (on page 10-1): Provides answers to frequently asked questions to help you troubleshoot common problems encountered with the Model 2657A.
- [Next steps](#) (on page 11-1): Provides information about additional resources that can help you use the Model 2657A.

Bookmarks for each section are provided in the PDF version. The manual sections are also listed in the Table of Contents located at the beginning of this manual.

For more information about bookmarks, see Adobe® Acrobat® or Reader® help.

Applications

In addition to being a stand-alone instrument, the Keithley Instruments Model 2657A can intelligently connect to other instruments and multiple devices. This manual provides application examples that guide you through several common instrument-to-instrument scenarios. These applications are presented after the summary information about the Model 2657A, and include:

- [Making basic front-panel measurements](#) (on page 5-1): Demonstrates the basic measurement function using a single Model 2657A and a two-terminal device under test (DUT).
- [Measuring diode off-state breakdown](#) (on page 6-1): Two examples demonstrate how to use the Model 2657A to measure the reverse breakdown characteristics of a high voltage diode. The Model 2657A measures the leakage current as the reverse voltage is swept to the specified breakdown voltage of the diode.
- [Measuring capacitor leakage](#) (on page 7-1): Demonstrates how to use the Model 2657A to measure the leakage current and calculate the insulation resistance of a capacitor.
- [Measuring MOSFET characteristics](#) (on page 8-1): Two examples demonstrate how to use the Model 2657A to measure the drain to source breakdown voltage and leakage current of a MOSFET. These tests perform the BV_{dss} measurement and I_{dss} measurements.
- [Measuring thyristor DC characteristics](#) (on page 9-1): Three examples demonstrate how to use the Model 2657A to characterize several DC characteristics of gated thyristors.

Safe configuration and test setup

In this section:

Introduction	2-1
Using the Model 2657A with the Model 8010 test fixture	2-1
Using the Model 2657A in a custom test fixture or system.....	2-3

Introduction

The Model 2657A can generate hazardous voltages. It is intended for use with a test fixture or in a test system that has safety mechanisms in place to prevent an operator from accessing these voltages.

This section describes how to use the Model 2657A with:

- The optional Keithley Instruments Model 8010 High Power Device Test Fixture
- A custom test fixture or system

Using the Model 2657A with the Model 8010 test fixture

The Model 8010 test fixture is designed to safely and easily interface to the Model 2657A for quick testing of a variety of packaged devices.

Only one Model 2657A may be connected to the Model 8010. However, you can connect other Keithley SourceMeter Instruments (SMUs) to the Model 8010 for testing multi-pin devices. See the Model 8010 User's Manual for a list of supported instruments.

The Model 8010 provides a safety interlock for up to six SMUs, including the Model 2657A. Opening the test fixture lid disables the output of any SMU that can produce hazardous live voltages (more than 42 V_{peak}). Closing and latching the lid enables testing with hazardous voltages.

To connect the safety interlock from the Model 8010 to the Model 2657A, use the CA-558-2 cable assembly. This cable is supplied with the Model 8010. The cable assembly connects the safety interlock pins on the digital I/O connector of the Model 2657A to any one of the Series 26xxA Interlock connectors on the rear panel of the Model 8010. See [Model 8010 to Model 2657A rear panel connections](#) (on page 2-2) for connection details.

WARNING

The Model 2657A is provided with an interlock circuit that must be positively activated in order for the high voltage output to be enabled. The interlock helps facilitate safe operation of the equipment in a test system. Bypassing the interlock could expose the operator to hazardous voltages that could result in personal injury or death.

To connect the Model 2657A output to the Model 8010, use only Model HV-CA-554 high-voltage triaxial cable assemblies. See the following figure for connections.

Be sure to connect the Model 8010 to protective earth (safety ground) using the screws on its rear panel.

WARNING

The ground wires must be attached to a known protective earth (safety ground) before powering on instruments. Failure to attach the ground wires to a known protective earth may result in electric shock.

Refer to the Model 8010 User's Manual for additional details.

Figure 1: Model 8010 to Model 2657A rear panel connections

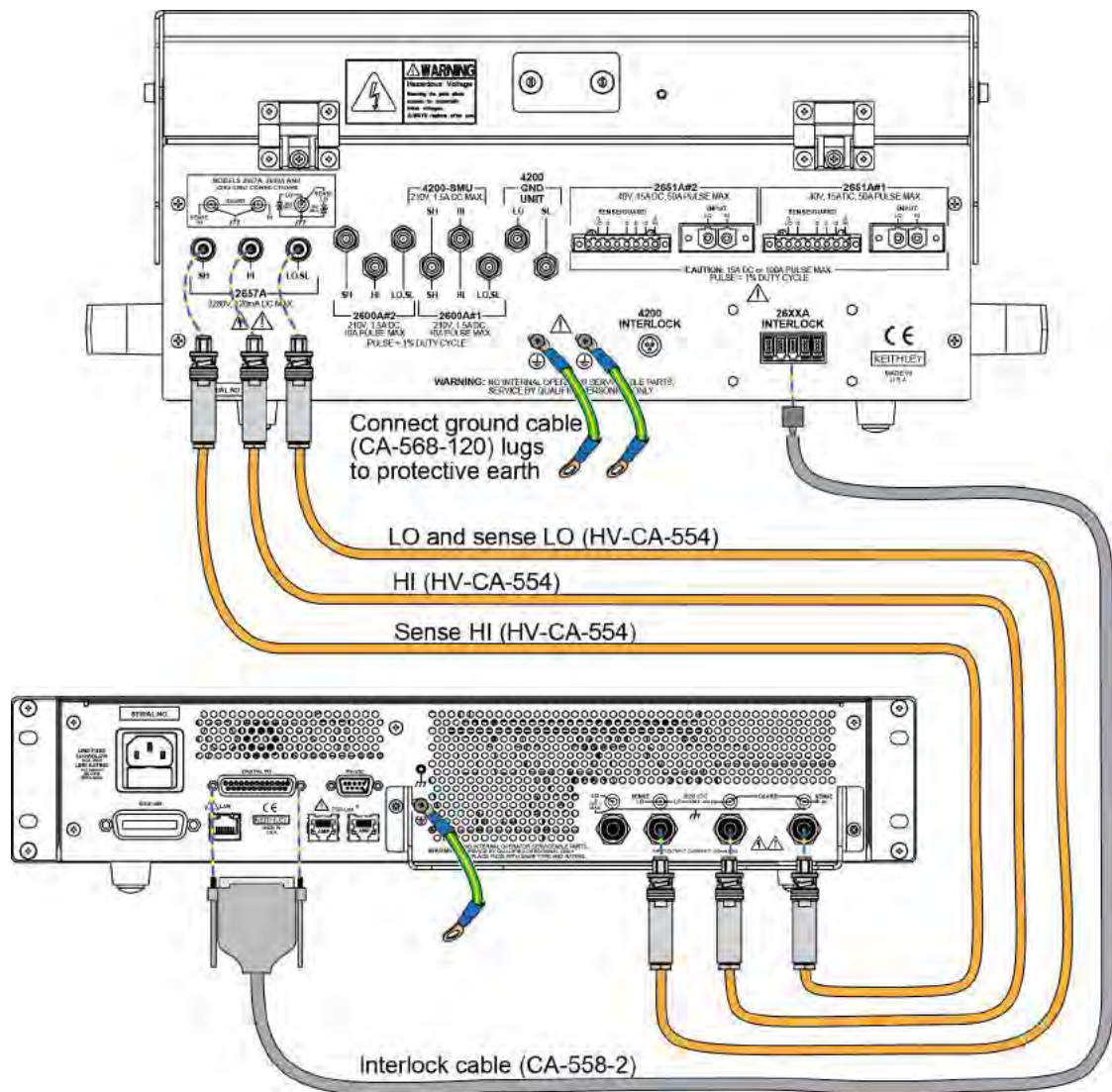

Using the Model 2657A in a custom test fixture or system

You can use the Model 2657A safely with a properly designed custom test fixture or with a semiconductor device prober or handler.

WARNING

Connect the enclosure of all metal test fixtures to protective earth (safety ground). Nonconductive test fixtures must be rated to double the maximum capability of the test equipment in the system. Failure to attach the ground wires to a known protective earth may result in electric shock.

Connecting the interlock of the Model 2657A

The graphic below shows how the interlock pin controls the high voltage supply.

Figure 2: Interlock control of the high voltage power supply

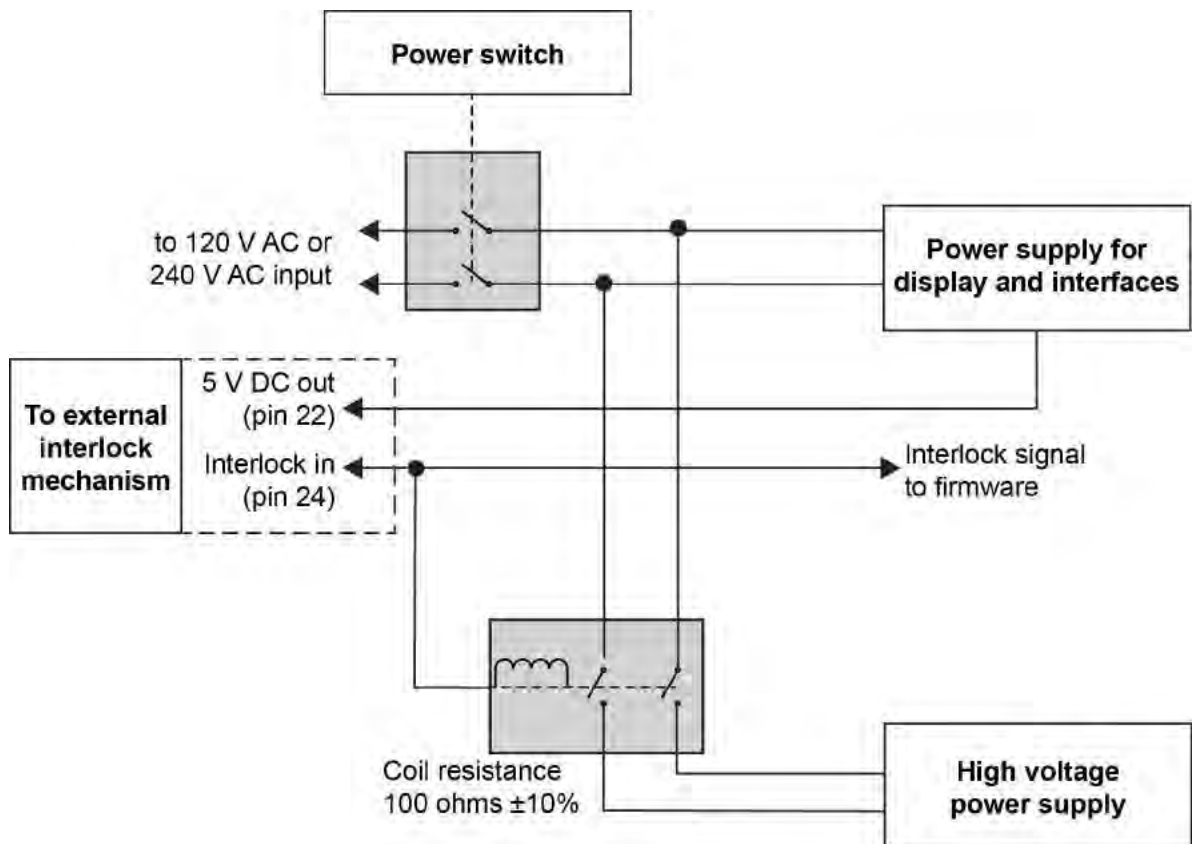

The output of the Model 2657A can only be turned on when the interlock is engaged. Attempting to turn on the output when the interlock is disengaged will generate error code 802, "Output Blocked by Interlock."

The interlock is engaged when the interlock pin is pulled high through a switch to more than +4 V. To drive the interlock pin high, the external supply must supply a minimum of 50 mA. The interlock is disengaged when the signal applied is less than +4 V. The absolute maximum input is -0.4 V to +6.0 V.

The interlock is intended for use through a normally open switch, which may be installed on the lid of a test fixture, on the enclosure of a semiconductor prober or device handler, or on the door or doors of a test equipment rack.

Connecting the Model 2657A output to a custom test fixture

Keithley Instruments offers several accessories that can help you when building a custom test fixture or system.

You can use high voltage coaxial or triaxial connectors on your test fixture. The following sections show you how to connect from the Model 2657A to the custom fixture and also how to make connections to the device inside the custom fixture.

Using coaxial connections (SHV)

You may need to adapt connections from the Model 2657A to safe high-voltage (SHV) coaxial connections in your test system. For this situation, you can use the Keithley Instruments Model SHV-CA-553 high-voltage triaxial to SHV cable assemblies.

NOTE

The inner shield of the high-voltage triaxial connector is not carried to the SHV connector end. The result of this is that portions of the test setup are unguarded. This can increase source and measurement settling time. It can also degrade low-current measurement performance.

Figure 3: High-voltage triaxial to SHV cable assembly (SHV-CA-553)



Figure 4: High-voltage triaxial to SHV coaxial cable assembly schematic

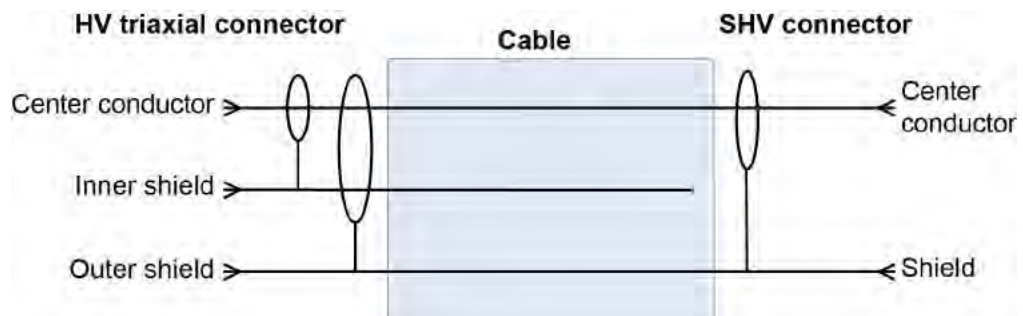

Be aware that when you connect the Model SHV-CA-553 cable assembly to the SLO/LO triaxial connector on the rear panel of the Model 2657A, the LO terminal is the inner (or first) shield. Therefore, the LO terminal is not carried to the SHV end of the Model SHV-CA-553 cable assembly. Use the LO triaxial connector on the rear panel of the Model 2657A to access Output LO.

WARNING

If you need to convert from safe high-voltage (SHV) to another connector type, be sure to only adapt SHV connectors to connectors that are rated to the maximum possible voltage in your test setup. If you use adapters that are not rated to the maximum possible voltage in your test setup, electric shock may result.

Four-wire connections to a test fixture with SHV connectors

The following figure is an example that demonstrates the 4-wire connections from the Model 2657A to a resistor installed in a custom test fixture with SHV connectors.

Figure 5: Four-wire connections to a custom test fixture with SHV connectors

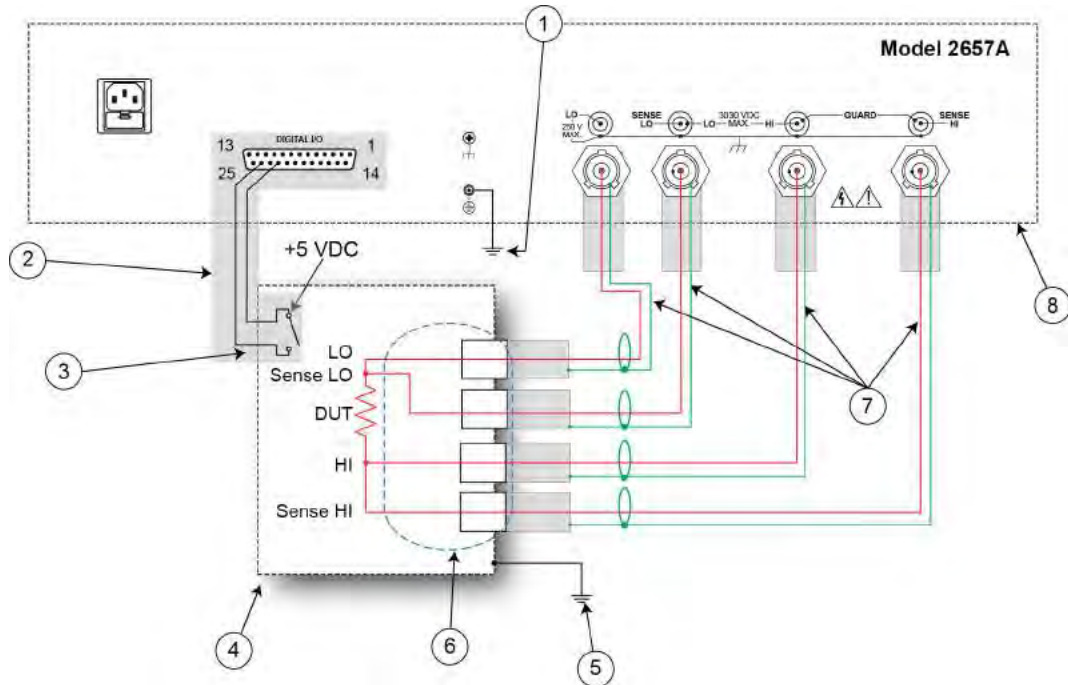

Item	Description	Qty	Notes
1	Model 2657A protective earth (safety ground)	1	Additional connections for redundant protective earth may be required. Keithley Instrument's Model CA-568 is a protective earth (safety ground) cable assembly.
2	Interlock connection	1	Model 2657A digital I/O; pin 24 (INT) and pin 22 (5 VDC) connected to the test fixture lid switch. Keithley Instrument's Model 7709-308 is a 25-pin interlock male connector that can be used for custom connections. Interlock switch is shown in the disengaged (lid open) position.
3	Test fixture interlock switch connection	1	
4	Interlocked metal safety enclosure	1	A safety enclosure with an interlock that has a normally-open (NO) switch.
5	Test fixture protective earth (safety ground)	1	Redundant grounds may be required for specific test setups.
6	Sense HI, HI, LO, and sense LO panel-mount SHV connections	4	Customer-supplied.
7	Model SHV-CA-553 High-Voltage Triaxial to SHV Cable	4	
8	Model 2657A	1	

Figure 6: Physical four-wire connections to a test fixture with SHV connectors

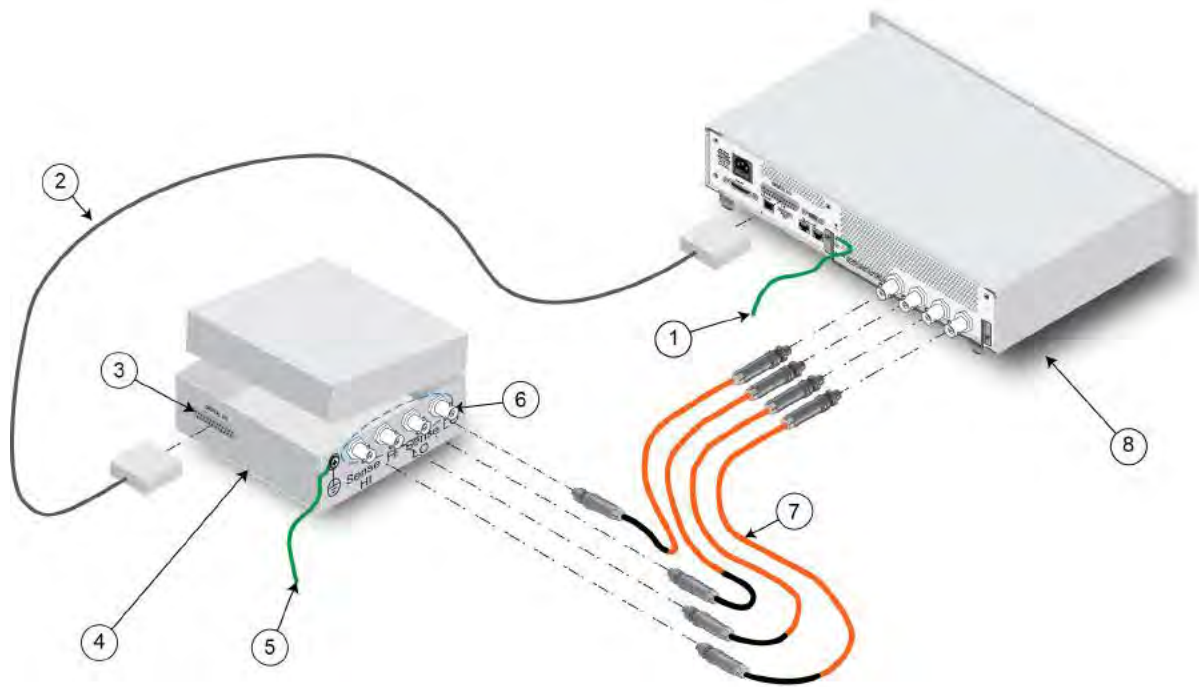

Using high-voltage triaxial connectors

You may use the Keithley Instruments HV-CA-571-3 cable assembly to create custom test fixtures or systems with panel-mount high-voltage triaxial connectors. Use the HV-CA-554 cable assemblies to connect the Model 2657A to these custom test fixtures.

Figure 7: Connect to custom test fixtures with the HV-CA-571-3 cable assembly

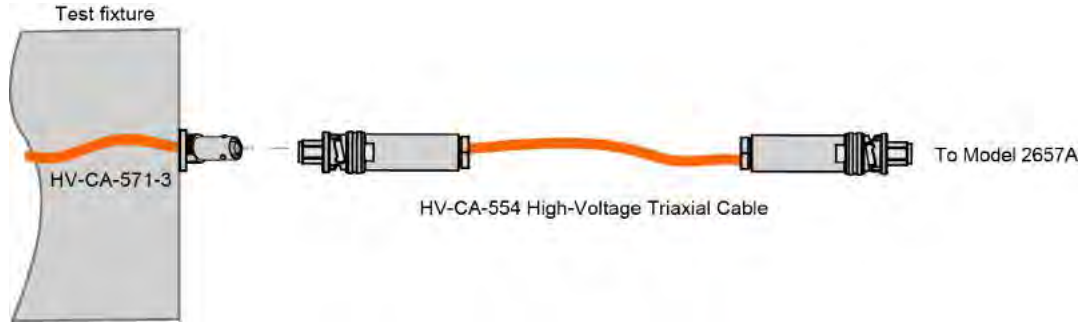

The HV-CA-571-3 is supplied with one unterminated end. It is intended to be used in a safe enclosure.

To properly connect the unterminated end to points in your test circuit, ensure proper voltage spacing for the maximum possible voltage in your test system. For 3000 V, ensure these spacings:

Figure 8: Voltage spacing

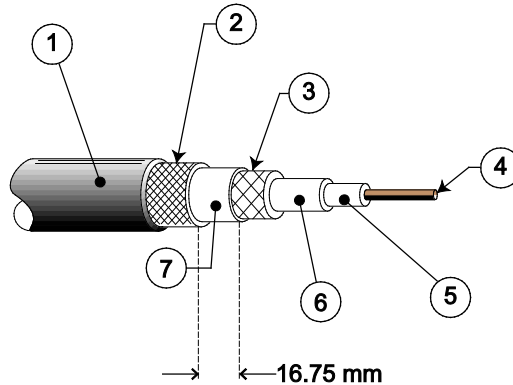

Item	Description	Notes
1	Outer jacket	
2	Outer shield	
3	Inner shield	Spacing between the inner shield and any user accessible circuit: 33.5 mm; spacing between the inner shield and a metal enclosure (if used): 16.75 mm
4	Center conductor	Spacing between the center conductor: <ul style="list-style-type: none"> • And any user accessible circuit: 33.5 mm • And a metal enclosure (if used): 16.75 mm
5	First dielectric	
6	Second dielectric	
7	Inner jacket	With wrapped tape barrier. Minimum spacing between inner and outer shield: 16.75 mm.

Please note how the above spacing requirements relate to the output terminals of the Model 2657A:

Figure 9: Model 2657A HI and SHI terminals

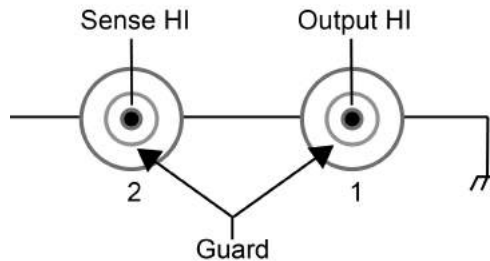

Follow all spacing requirements as described in [Using high-voltage triaxial connectors](#) (on page 2-7).

For the Sense LO and LO terminals, the center conductor and first shield should be within a few volts of each other to guarantee normal operation. Therefore, there is minimal space required between these two conductors.

Figure 10: Model 2657A Sense LO and output LO terminal

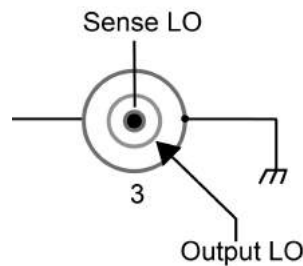
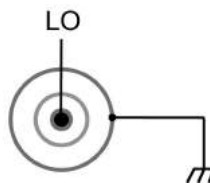

Figure 11: Model 2657A LO terminal



⚠ WARNING

Connections to LO on the Model 2657A are not necessarily at 0 V. Hazardous voltages could exist between LO and chassis ground. Make sure that high-voltage precautions are taken throughout the test system. Alternatively, limit hazardous levels by adding external protection to limit the voltage between LO and chassis. Failure to make sure high-voltage precautions are used throughout the test system or a failure to limit hazardous levels could result in severe personal injury or death from electric shock.

Four-wire connections to a test fixture with HV triaxial connectors

The following graphic demonstrates 4-wire connections from the Model 2657A to a resistor in a custom test fixture that uses Keithley Instruments high-voltage triaxial connectors.

NOTE

You may need additional connections for redundant protective earth (safety ground) that are not shown in the following graphic.

⚠ WARNING

Hazardous voltages may be present on all output and guard terminals. To prevent electrical shock that could cause injury or death, never make or break connections to the Model 2657A while the instrument is powered on. Turn off the equipment from the front panel or disconnect the main power cord from the rear of the Model 2657A before handling cables. Putting the equipment into standby does not guarantee that the outputs are powered off if a hardware or software fault occurs.

Figure 12: Model 2657A four-wire connections (remote sensing)

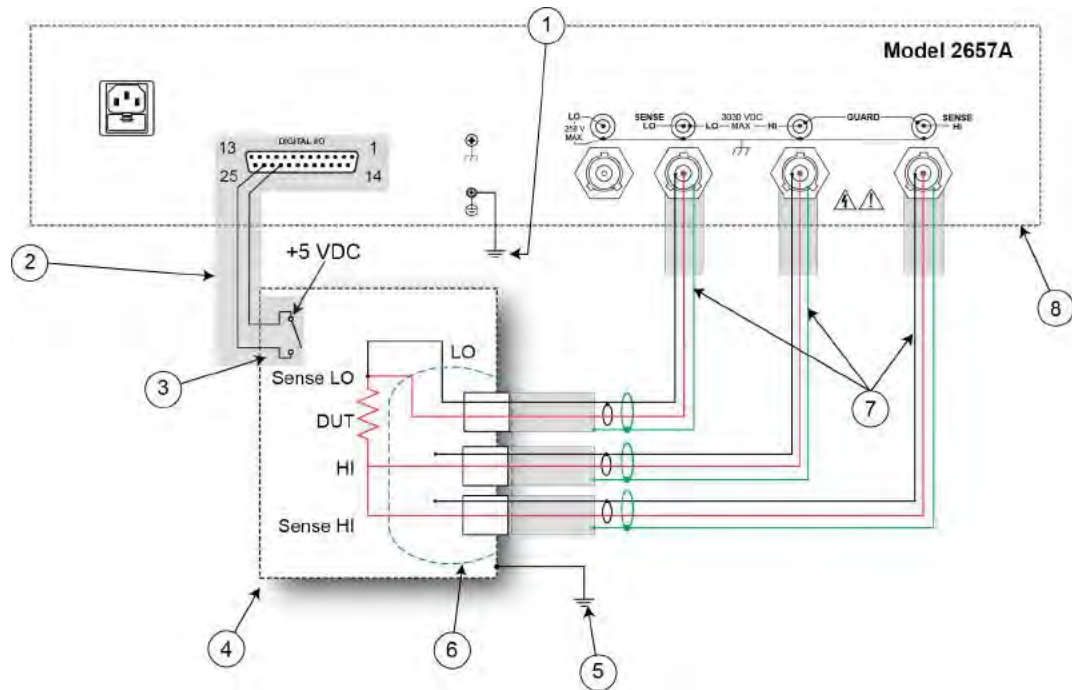

Item	Description	Qty	Notes
1	Model 2657A protective earth (safety ground)	1	Additional connections for redundant protective earth may be required. Keithley Instrument's Model CA-568 is a protective earth (safety ground) cable assembly.
2	Interlock connection	1	Model 2657A digital I/O pin 24 (INT) and pin 22 (5 VDC) connected to the test fixture lid switch. Keithley Instrument's Model 7709-308 is a 25-pin interlock male connector that can be used for custom connections. Interlock switch is shown in the disengaged (lid open) position.
3	Test fixture interlock switch connection	1	
4	Interlocked metal safety enclosure	1	A safety enclosure with an interlock that has a normally-open (NO) switch.
5	Test fixture protective earth (safety ground)	1	Redundant grounds may be required for specific test setups.
6	Model HV-CA-571-3 High-Voltage Triaxial Panel-Mount Connector to Unterminated Cable Assembly	3	See schematic for connections. Refer to Using high-voltage triaxial connectors (on page 2-7).
7	Model HV-CA-554 High-Voltage Triaxial Cable	3	
8	Model 2657A	1	

Figure 13: Model 2657A four-wire connections (remote sensing) physical connections

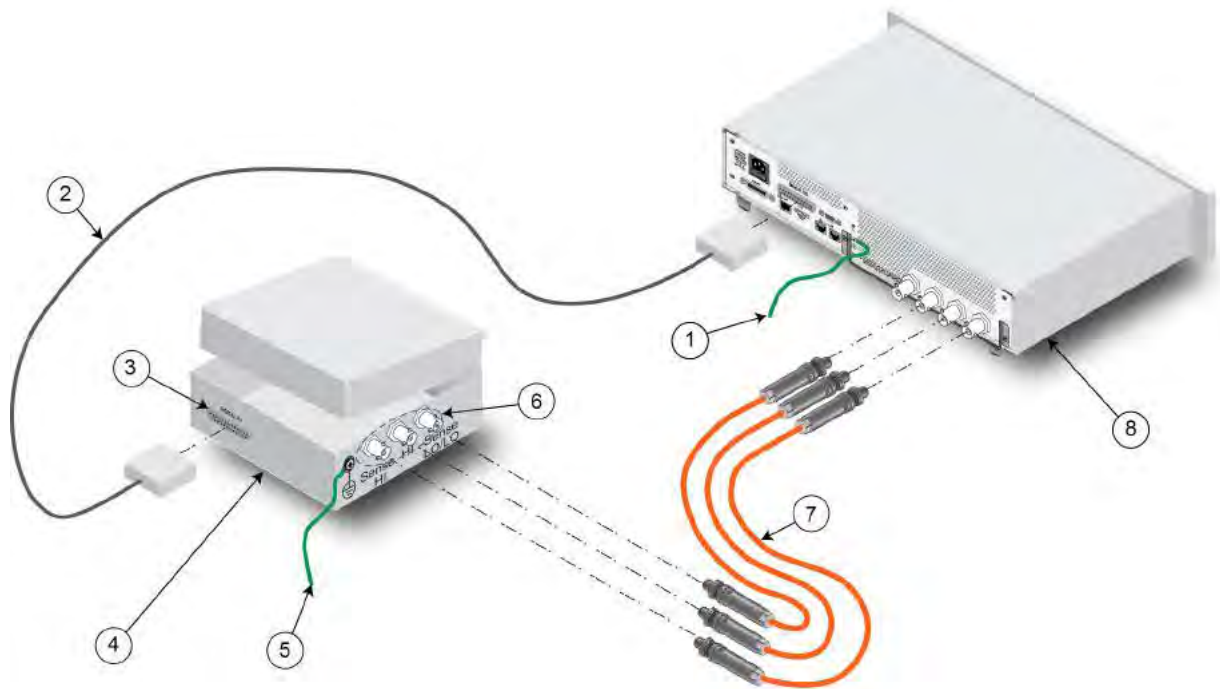

Using the front-panel interface

In this section:

Introduction	3-1
Front panel.....	3-2

Introduction

Before starting this section, complete the tasks outlined in the Model 2657A Quick Start Guide. Once you have completed those tasks, read this section, which provides enough basic information about the Model 2657A front-panel interface to work through the examples provided in this manual.

The front panel of the Keithley Instruments Model 2657A contains the following items:

- POWER switch
- Display
- The navigation wheel 
- The setup and control keys

You can use the keys, display, and the navigation wheel  to access, view, and edit the menu items and to set values.

For additional information about the front panel, see the “General operation” section in the Model 2657A Reference Manual.

WARNING

The power cord supplied with the Model 2657A contains a separate ground wire for use with grounded outlets. When proper connections are made, the instrument chassis is connected to power-line ground through the ground wire in the power cord. Ensure that the protective earth (safety ground) terminal is properly connected to a known protective earth (safety ground) before operating the instrument. Failure to use a grounded outlet may result in personal injury or death due to electric shock.

CAUTION

Operating the instrument on an incorrect line voltage may cause damage to the instrument, possibly voiding the warranty.

Front panel

The front panel of the Model 2657A is shown below.



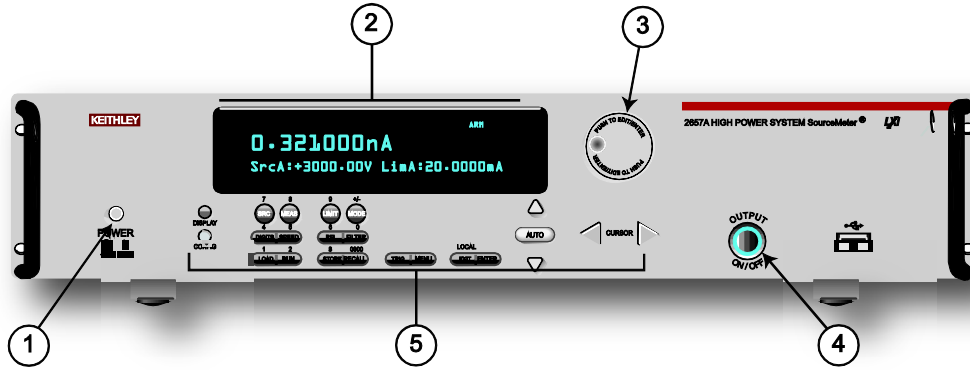

Figure 14: Front panel



- (1) The **POWER** switch. Press this switch to turn the instrument on (I). Press it again to turn the instrument off (O).
- (2) The display. During operation, the display provides readings and information about the selected measurement and configuration. It also shows the control status (local or remote). If REM is displayed, the instrument is being controlled remotely (through GPIB, LAN, or RS-232). If REM is not displayed, control is through the front panel.

During setup, the display shows menu choices that you can use to configure the instrument. The items listed below represent the possible display indicators and what they mean.

Indicator	Meaning
EDIT	Instrument is in editing mode
ERR	Questionable reading or invalid calibration step
REM	Instrument is in remote mode
TALK	Instrument is addressed to talk
LSTN	Instrument is addressed to listen
SRQ	Service request is asserted
REL	Relative mode is enabled
FILT	Digital filter is enabled
AUTO	Source or measure autorange is selected
* (asterisk)	Readings are being stored in the buffer



- (3) The navigation wheel . Turn the navigation wheel  to scroll to a menu option or to change the selected value.
Push the navigation wheel  to open menus or to select a menu option or a value. In most cases, pressing the navigation wheel  performs the same action as pressing the **ENTER** key.
- (4) The **OUTPUT ON/OFF** control. Press this control to turn the Model 2657A source output on or off. The output indicator will light when the source is on.

- (5) The setup and control keys. These keys provide front panel control and configuration. The following figure illustrates each key's location. The table following the figure contains a definition of each key.

Figure 15: Setup and control keys



Key descriptions

Key	Description
DISPLAY	Toggles between the source-measure displays and the user message mode.
CONFIG	Configures a function or operation.
SRC	Selects the source function (V or A) and places the cursor in the source field for editing.
MEAS	Cycles through measure functions (V, A, Ω, or W).
LIMIT	Places the cursor in the compliance limit field for editing. Also selects the limit value to edit (V, A, or W).
MODE	Directly controls the mode.
DIGITS	Cycles through display resolution (4½, 5½, or 6½ digits).
SPEED	Selects either the fast or integrating analog-to-digital converter (ADC). When the integrating ADC is selected, this key also sets the measurement speed and accuracy by controlling the measurement aperture.
REL	Controls relative measurements. This allows a baseline value to be subtracted from a reading.
FILTER	Enables or disables the digital filter. You can use this filter to reduce reading noise.
LOAD	Loads a test for execution.
RUN	Runs the last selected factory or user-defined test code.
STORE	Accesses reading buffers and takes readings.
RECALL	Recalls data (or statistics) from CHANA-BUFF1 or CHANA-BUFF2.
TRIG	Triggers readings.
MENU	Accesses the main menu. The main menu can be used to configure many facets of operation.
EXIT (LOCAL)	Cancels the selection and backs out of the menu structure. Also used as a LOCAL key to take the instrument out of remote operation.
ENTER	Accepts the current selection or opens the next menu option. In most cases, pressing the ENTER key is the same as pressing the navigation wheel  .
Number keys	When enabled, the number keys (0-9, +/-, 0000) allow direct numeric entry when the instrument is in the EDIT mode. Press the navigation wheel  to enter EDIT mode (see To change a value using the numeric keypad (on page 3-4)).

Placing a Model 2657A in standby

WARNING

Hazardous voltages may be present on all output and guard terminals. To prevent electrical shock that could cause injury or death, never make or break connections to the Model 2657A while the instrument is powered on. Turn off the equipment from the front panel or disconnect the main power cord from the rear of the Model 2657A before handling cables. Putting the equipment into standby does not guarantee that the outputs are powered off if a hardware or software fault occurs.

When the instrument is on, you can place the output in an active output state (output on) or a standby mode (output off). From the front panel, press the **OUTPUT ON/OFF** control to toggle the output using the present instrument configuration. You can also place the output in standby over the remote interface by sending the following command:





```
smua.source.output = 0
```

Even though the instrument is placed in standby, the output may not be actually off.

Changing values from the front panel

You can use the navigation wheel or the number pad to change values on the display, as described in the following sections.

To change a value using the navigation wheel :

1. Turn the navigation wheel  to go to the character you want to change (the character blinks when selected).
2. Press the navigation wheel  to edit that character.
3. Turn the navigation wheel  to change the value.
4. Press the navigation wheel  to enter the change.
5. Repeat these steps as needed to change the value.
6. Press the **ENTER** key or the navigation wheel  when finished changing all the characters.

To change a value using the numeric keypad:

1. You must enable the keypad. Press the **MENU** key, then select **DISPLAY > NUMPAD > ENABLE**.
2. Use the **CURSOR** arrow keys to move the cursor to the value that you want to edit.
3. Press the number keys (0-9, +/-, 0000). The cursor moves to the next value on the right.
4. Repeat the above steps as required to set the desired values.
5. Press the **ENTER** key to accept the value or press the **EXIT (LOCAL)** key to cancel the change.
6. (Optional) Press the **EXIT (LOCAL)** key to return to the main menu.

Using the web interface

In this section:

Introduction	4-1
Connecting to the instrument web interface	4-1
Web interface home page	4-2
IP configuration tab	4-3
TSB Embedded.....	4-4
Reading buffers.....	4-7
TSP Express	4-9

Introduction

The Model 2657A web interface allows you to review instrument status, control the instrument, and upgrade the instrument over a LAN connection.

The instrument web page resides in the firmware of the instrument. Changes you make through the web interface are immediately made in the instrument.

Many examples in this manual and in the Model 2657A Reference Manual can be run through the TSB Embedded page of the instrument web interface.

Connecting to the instrument web interface

NOTE

The instrument web interface requires the web browser plug-in Java™ SE Runtime Environment Version 6 or later. The latest version of the plug-in is available from <http://www.java.com/en/download/manual.jsp> (<http://www.java.com/en/download/manual.jsp>). Installation files are also available on the Model 2657A Product Information CD-ROM that came with your instrument.

The instrument web interface uses Java applets and, depending on your browser security settings, may require your permission to download and install them.

To connect to the instrument web interface, you must have a LAN connection from the computer to the instrument. See "LAN concepts and settings" in the Model 2657A Reference Manual for more information about configuring the Model 2657A for a LAN connection, connecting the Model 2657A to the LAN, and establishing a LAN connection to the instrument.

Once the Model 2657A is configured correctly and connected to the LAN, you can use the Keithley LXI® Discovery Browser to identify the IP addresses of instruments that are connected to the LAN and that support the VXI-11 discovery protocol as required by LXI. You can also manually set up the IP address.

The Keithley LXI Discovery Browser is available on the instrument CD. It is also available on the [Keithley Instruments website](#) .

To locate the Keithley LXI Discovery Browser on the Keithley website:

1. Select the **Support** tab.
2. In the model number box, type **2657A**.
3. From the list, select **Software** and click the search icon. A list of software applications for the instrument is displayed.
4. See the readme file included with the application for more information.

For more information about the LXI Consortium, see the [LXI Consortium website](http://www.lxistandard.org) (<http://www.lxistandard.org>).

To use the Keithley LXI Discovery Browser to identify IP addresses:

1. From the Windows Start Menu, select **Keithley Instruments**.
2. In the LXI Discovery Browser folder, double-click **LXI Discovery Browser**.
3. The tool should automatically identify the IP addresses of connected instruments. If no IP addresses are shown, click **Refresh**.
4. Double-click the IP address in the Browser to open the web interface for the instrument.

To manually set up the IP address to connect the instrument to the web interface:

1. Connect the Model 2657A to the LAN and confirm that the LAN light on the instrument is illuminated. The LAN light is located on the rear panel as part of the LAN RJ-45 connector.
2. Open an Internet browser, such as Microsoft® Windows® Internet Explorer® (version 6.0 or later only).
3. If you do not know the IP address, press the **MENU** key on the instrument front panel and then select **LAN > STATUS > IP-ADDRESS**.
4. In the Address box of the Internet browser, enter the IP address of the instrument and press **Enter**.

The home page of the instrument web interface is displayed.

Web interface home page

The Welcome page of the web interface gives you basic information about the instrument, including:

- The instrument model, serial number, firmware revision, calibration date, and LXI information
- An **ID** button to help you locate the instrument
- Links to the instrument web options, including TSB Embedded, Reading Buffers, Flash Upgrade, and TSP® Express.

IP configuration tab

The IP Configuration tab provides access to the Model 2657A LAN settings. Refer to the Model 2657A Reference Manual for additional information about IP configuration.

NOTE

You must reload the page if you change the LAN settings from the Modify IP configuration page. If the IP address changes (due to automatic configuration mode or changing the setting to a different static IP address), you must type the new IP address in the address bar of your Internet browser before you can use the web interface again.

The screenshot displays the LXI Web Interface for a Keithley 2657A System SourceMeter. The interface includes a navigation menu on the left and a main configuration table. The table lists various system parameters such as Instrument Model, Manufacturer, Firmware Revision, Serial Number, Description, LXI Version, MAC Address, TCP/IP Address, Gateway, Subnetmask, Lan Connection, Host Name (FQDN), DNS Servers, Ports, and Instrument Address String.

LXI Web Interface - Welcome Page	
Instrument Model:	2657A System SourceMeter®
Manufacturer:	Keithley Instruments
Firmware Revision:	1.1.0rc20
Serial Number:	0000000
Description:	Keithley Instruments SMU 2657A - 0000000
LXI Extended Functions:	
LXI Version:	1.4 LXI Core 2011
MAC Address:	00:60:1A:00:8B:4E
TCP/IP Address:	10.60.8.81
Gateway:	10.60.8.1
Subnetmask:	255.255.255.0
Lan Connection:	100Mbps, Full Duplex
Host Name (FQDN):	10.60.8.81, k-2657A-0000000.local
DNS Servers:	
Ports:	DST: 5030 Raw Socket: 5025 Telnet: 23 VXI-11 Core: 1024
Instrument Address String:	TCP/IP[board]: 10.60.8.81:5025:SOCKET GPIB[board]: 26:INSTR ASRL[board]: INSTR TCP/IP[board]: 10.60.8.81:inst0:INSTR
Smu A Calibration Date:	
Smu A Calibration Due:	

TSB Embedded

TSB Embedded is a web application that includes a command-line interface that you can use to issue commands and interact with the instrument. TSB Embedded also provides a convenient way to create and manage user scripts. TSB Embedded resides in the instrument.

You can use TSB Embedded to run the application examples in other sections of this manual.

If you can access the web interface home page, but cannot use TSB Embedded (or TSP Express), make sure you have the Java™ SE Runtime Environment (JRE) Version 6 or later installed on your computer.

Create a script using TSB Embedded

NOTE

If you are using TSB Embedded to create scripts, you do not need to use the commands `loadscript` or `loadandrunscript` and `endscript`.

Exercise: Create and run a script with TSB Embedded

The following programming example illustrates the setup and command sequence of a basic source-measure procedure with the following parameters:

- Source function and range: voltage, autorange
- Source output level: 1000 V
- Current compliance limit: 10 mA
- Measure function and range: current, 20 mA

To create and run a sample script with TSB Embedded:

1. From the navigation on the left side of the web interface, select TSB Embedded. The TSB Embedded page is displayed.

Figure 16: Select TSB Embedded

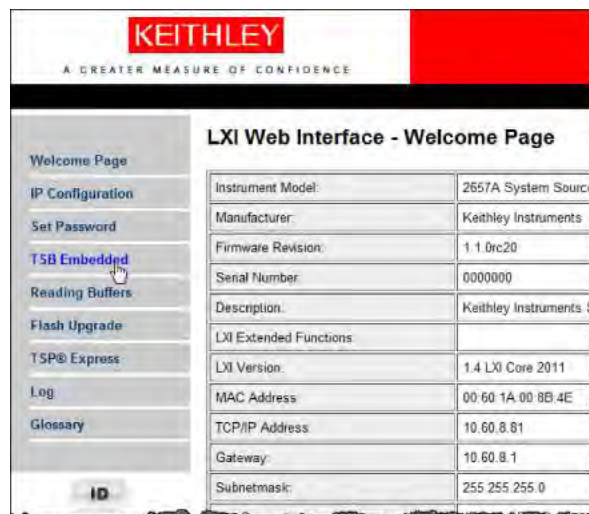

- To create the example script, in the TSP Script box, enter the name of the TSP script, `basic_source_measure`.

Figure 17: TSB Embedded page

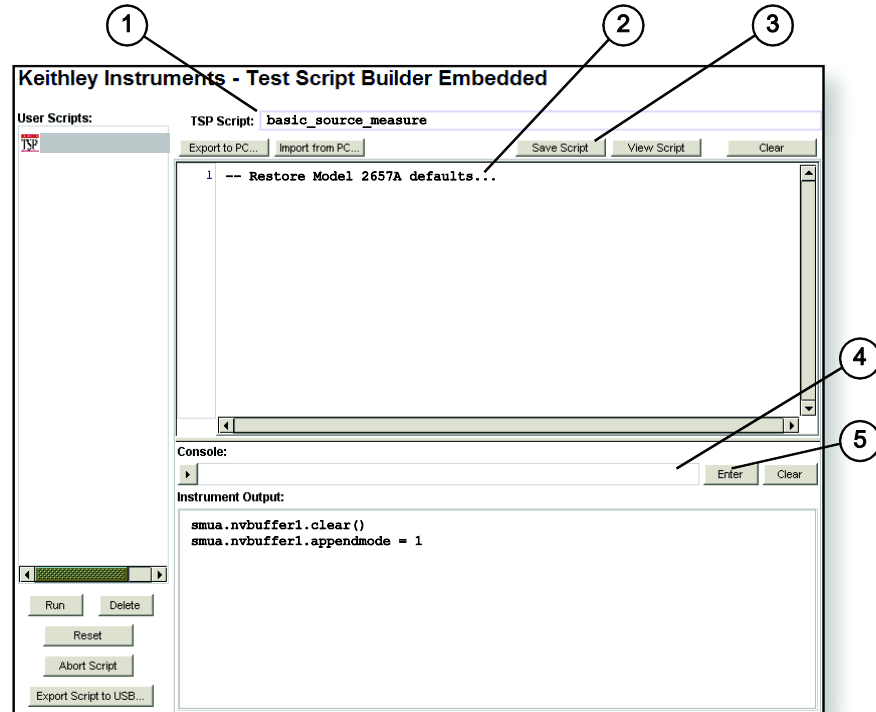

Item	Description
1	TSP script box
2	Script box
3	Save Script button
4	Console
5	Enter button

3. Enter the code below in the script box.

```
-- Restore Model 2657A defaults.
smua.reset()
-- Select voltage source function.
smua.source.func = smua.OUTPUT_DCVOLTS
-- Set source range to auto.
smua.source.autorangev = smua.AUTORANGE_ON
-- Set voltage source to 100 V.
smua.source.levelv = 100
-- Set current limit to 20 mA.
smua.source.limiti = 20e-3
-- Set current range to 20 mA.
smua.measure.rangei = 20e-3
-- Turn on output.
smua.source.output = smua.OUTPUT_ON
-- Print and place current reading in buffer.
print(smua.measure.i(smua.nvbuffer1))
-- Turn off output.
smua.source.output = smua.OUTPUT_OFF
-- Beep.
beeper.enable = beeper.ON
beeper.beep(1, 1200)
beeper.enable = beeper.OFF
```

NOTE

Commands and parameters for the Model 2657A are case-sensitive. It is important to type in the commands exactly as shown to avoid syntax and execution errors.

4. Click **Save Script**. The script is added to the User Scripts list on the left.

Quick Tip

You can use standard edit functions, such as copy, cut, and paste in TSB Embedded. The standard functions are available as both keyboard shortcuts and right-click menus.

5. Clear the buffer:

- In the console, type the following and then click **Enter**.
`smua.nvbuffer1.clear()`
- If successful, the command will appear in the Instrument Output box.

6. Set the buffer to append readings:

- In the console, type the following and then click **Enter**.
`smua.nvbuffer1.appendmode = 1`
- If successful, the command will appear in the Instrument Output box.

7. Set the buffer to collect timestamps:

- In the console, type the following and then click **Enter**.
`smua.nvbuffer1.collecttimestamps = 1`
- If successful, the command will appear in the Instrument Output box.

8. Run the script:

- Select the script in the User Scripts list.
- Click **Run**.

9. The Instrument Output box displays any error messages and output from the script.
10. If no errors appear, but readings do, click **Run** a few times to populate the buffer. Each time the script is run, readings appear in the Instrument Output box and are also placed in the buffer.

Script management options

Existing scripts are listed in the User Scripts box on the left side of TSB Embedded.

To run a script, click the name of the script and then click **Run**.

To delete a script, click the name of the script and click **Delete**. The script is deleted from the User Scripts list and from the nonvolatile memory of the instrument.

To stop operation of a script, click **Abort Script**.

To export the selected script to the computer, click **Export to PC**. Choose the directory in which to save the script and click **Save**. Scripts are saved to a file with the extension `t.sp`. TSP files are native to Test Script Builder or TSB Embedded, but they can be opened and edited in any text editor.

To import scripts from the computer, click **Import from PC**. Select the directory that contains the file. You can only import files with the extension `t.sp`.

To clear the name box and the box that contains the script, click **Clear**.

To view the contents of a script, type the name of a script in the TSP Script box and click **View Script**.

Reading buffers

The Reading Buffers tab provides access to the Model 2657A reading buffers. The data used in this example was created and placed in the buffer by the [Exercise: Create and run a script with TSB Embedded](#) (on page 4-4).

Exercise: Retrieve readings from a buffer

To retrieve readings from a populated buffer:

1. From the navigation area on the left side of the web interface, select **Reading Buffers**. The Reading Buffers embedded page is displayed.

Figure 18: Select reading buffer



- From the left box (1 in the following graphic), select `smua.nvbuffer1`.
- In the Recall Attributes area (near the bottom of the page, shown as 2 in the following graphic), select **Values** and **Time Stamp**.
- Click **Download** (shown as 3 in the following graphic).

Figure 19: Downloading the reading buffer

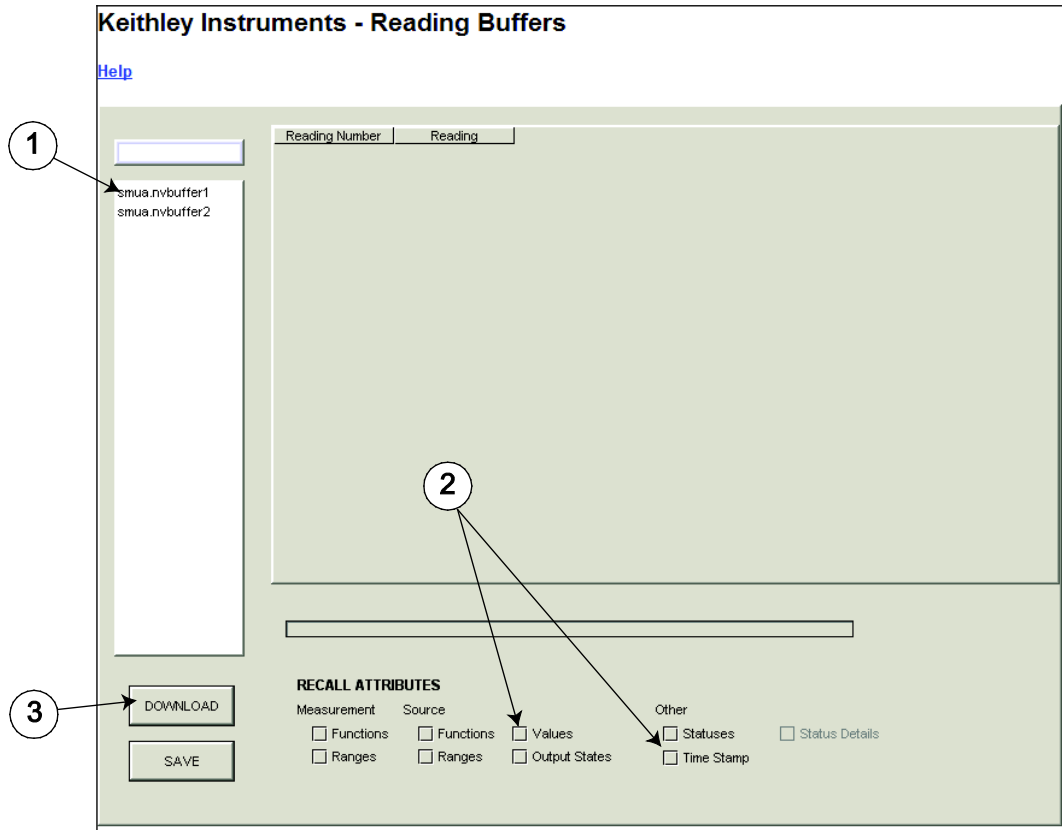

- The table displays the present buffer data. Notice that the Source Value column is not populated. To collect source values, before taking readings, use TSB Embedded to set the following attribute: `smua.nvbuffer1.collectsourcevalues = 1`.

Figure 20: Sample downloaded reading buffer

Reading Number	Reading	Source Value	TimeStamp
1	-1.46675048995...		0.0
2	-1.46675048995...		2.06658101081...
3	-1.10057605695...		3.89714288711...

TSP Express

The TSP[®] Express tab provides access to the TSP Express Launch page. From this page, click the **Launch** button to start TSP Express.

NOTE

Only one web application can be running and connected to the instrument at a time. TSP Express will not run if another web application, such as TSB Embedded, Reading Buffers, or Flash Upgrade, is running and connected to the instrument. If you need to run another web application, be sure to close TSP Express before starting the other web application.

Figure 21: Select TSP Express



To run TSP Express:

1. From the navigation area on the left side of the web interface, select **TSP Express**. The TSP Express page is displayed.
2. Click the **Launch** button. The TSP Express window opens.
3. There is a help pane on the right side of the TSP Express main window. You can adjust the width of the help pane by sliding the vertical bar. Click and follow the step-by-step example in the help pane to become familiar with TSP Express (there is a link to the example in the TSP Express Introduction's first paragraph).

Figure 22: TSP Express

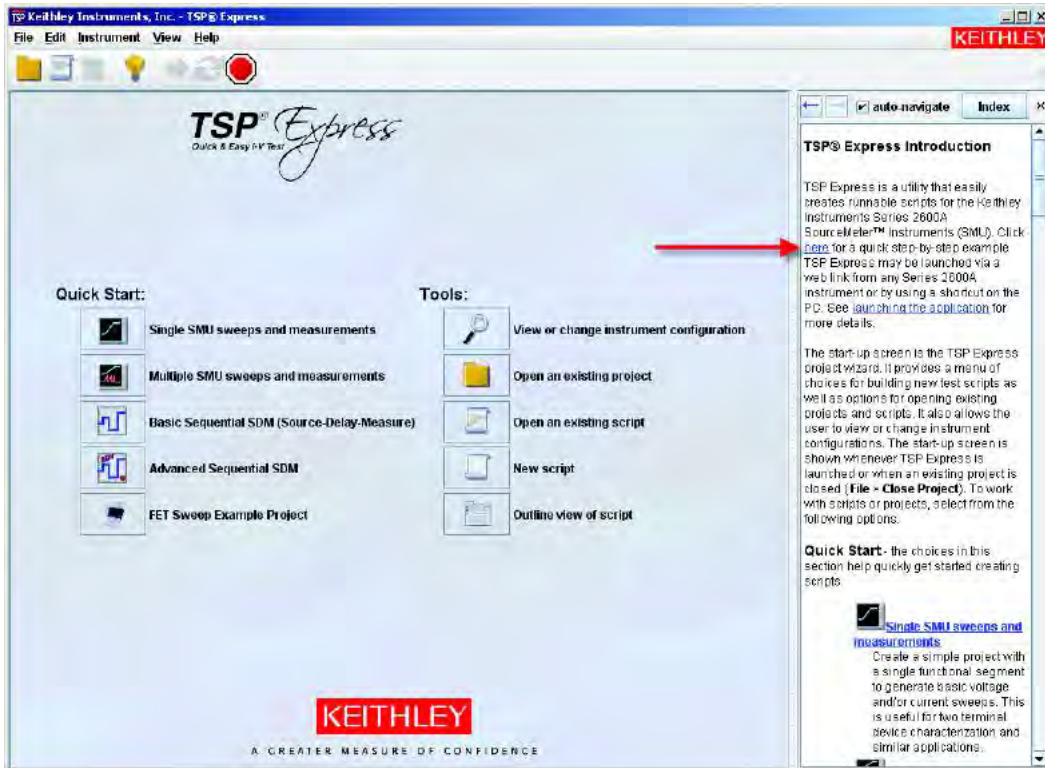

Section 5

Making basic front-panel measurements

In this section:

Introduction	5-1
Equipment needed for this example	5-1
Device connections	5-2
Making front-panel measurements	5-4

Introduction

You can use the Model 2657A to make basic measurements from the front panel. In this example, measurements are made on a 100 MΩ resistor. Similar measurements can be made on any two-terminal device under test (DUT) if appropriate source values are used.

Equipment needed for this example

To run this example, you will need the following equipment:

- Model 2657A High Power System SourceMeter® instrument.
- Additional cable and connector assemblies as required to make connections to the DUT. See [Device connections](#) (on page 5-2) for a schematic of required connections.
- A 100 MΩ resistor to test, enclosed in a safe test fixture such as the Keithley Instruments Model 8010. The resistor should be rated for at least 1000 V.
- Appropriate cabling to the test fixture.

See [Safe configuration and test setup](#) (on page 2-1) for additional connection information.

Device connections

Connections from the Model 2657A to the DUT are shown in the illustrations on the following pages. Proper care should be taken to ensure good contact through all connections.

WARNING

The information in this topic is intended only for qualified service personnel. Some of the procedures may expose you to hazardous voltages that could result in personal injury or death. Do not attempt to perform these procedures unless you are qualified to do so.

Hazardous voltages may be present on all output and guard terminals. To prevent electrical shock that could cause injury or death, never make or break connections to the Model 2657A while the instrument is powered on. Turn off the equipment from the front panel or disconnect the main power cord from the rear of the Model 2657A before handling cables. Putting the equipment into standby does not guarantee that the outputs are powered off if a hardware or software fault occurs.

Guard voltage can be hazardous. With an unguarded device under test (DUT) connection, terminate the guard before the end of the cable. Refer to High-voltage triaxial cable termination for details.

Connect the enclosure of all metal test fixtures to protective earth (safety ground) (see your specific test fixture for information). Nonconductive test fixtures must be rated to double the maximum capability of the test equipment in the system.

Figure 23: Connections for basic front-panel measurement application

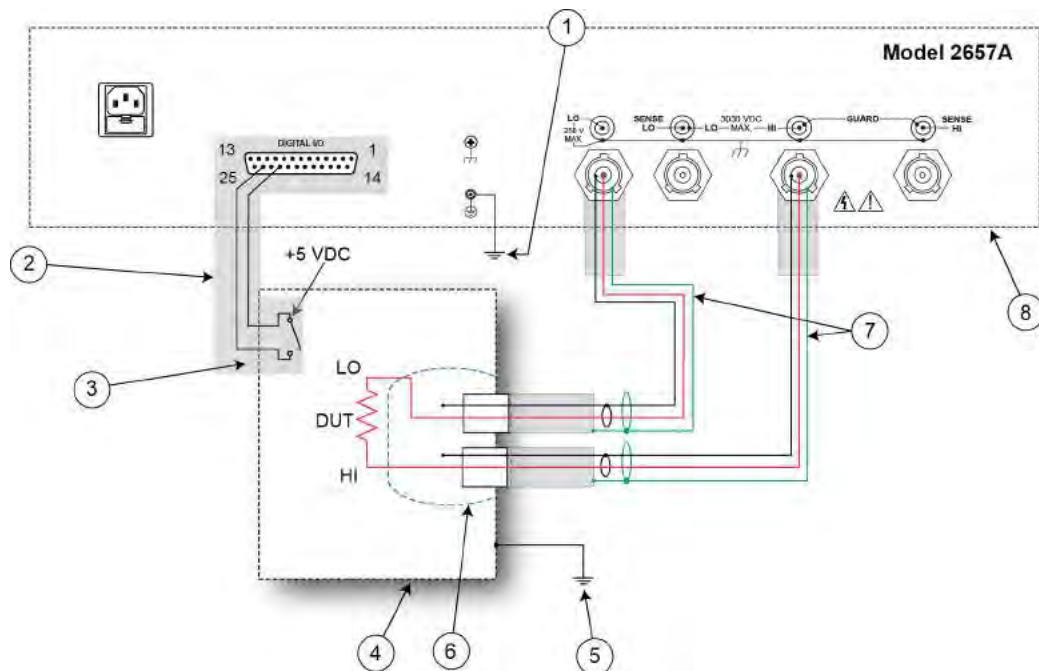

Item	Description	Qty	Notes
1	Model 2657A protective earth (safety ground)	1	Additional connections for redundant protective earth may be required. Keithley Instrument's Model CA-568 is a protective earth (safety ground) cable assembly.
2	Interlock connection	1	Model 2657A digital I/O; pin 24 (INT) and pin 22 (5 VDC) connected to the test fixture lid switch. Keithley Instrument's Model 7709-308 is a 25-pin interlock male connector that can be used for custom connections. Interlock switch is shown in the disengaged (lid open) position.
3	Test fixture interlock switch connection	1	
4	Interlocked metal safety enclosure	1	A safety enclosure with an interlock that has a normally-open (NO) switch.
5	Test fixture protective earth (safety ground)	1	Redundant grounds may be required for specific test setups.
6	Model HV-CA-571-3 High-Voltage Triaxial Panel-Mount Connector to Unterminated Cable Assembly	2	See Using high-voltage triaxial connectors (on page 2-7) for detail.
7	Model HV-CA-554 High-Voltage Triaxial Cable	2	
8	Model 2657A	1	

Figure 24: Physical connections for basic front-panel measurement application

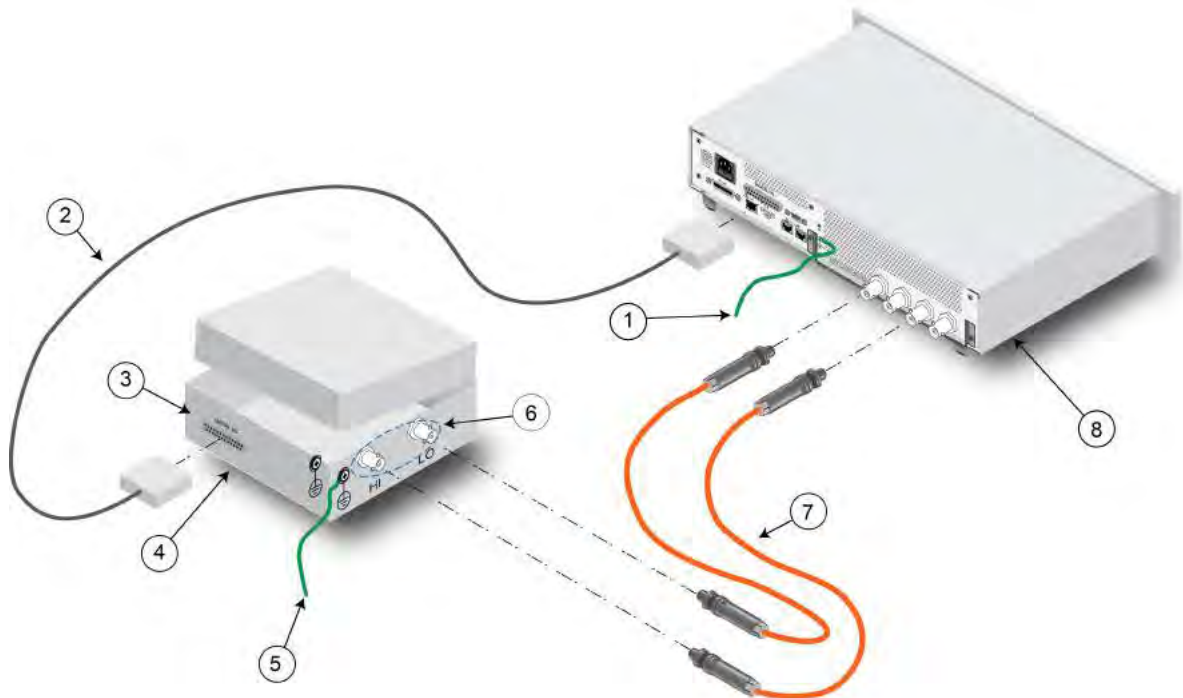

Making front-panel measurements

Use the following procedure to configure the instrument and make measurements from the front panel.



NOTE

If you see error code 802, "OUTPUT blocked by interlock," the interlock is not engaged. To recover from this error, properly engage the interlock using a safe test fixture, and then turn on the Model 2657A output.

Procedure for making front-panel measurements



Step 1: Select and set source level

Perform the following steps to select the voltage source and set its value to 1000 V:

1. Press the **SRC** key as needed to select the **V-Source**, as indicated by the units in the source field on the display. The flashing digit (cursor) indicates which value is selected for editing.
2. Move the cursor to the digit to change, then press the navigation wheel  to enter the EDIT mode, as indicated by the EDIT indicator.
3. Use the **RANGE** keys to select the 1500 V range. If using a different source value, use the lowest possible range for the best accuracy.
4. Set the source value to 1000.00 V, and then press the **ENTER** key or the navigation wheel  to complete editing.

Step 2: Set compliance limit

Perform the following steps to edit the compliance limit value to 100 μ A:

1. Press the **LIMIT** key.
2. Move the cursor to the digit to change, then press the navigation wheel  to enter the EDIT mode, as indicated by the EDIT indicator.
3. Enter the limit value of 100.00 μ A.
4. Press the **ENTER** key or the navigation wheel  to complete editing.

Step 3: Select measurement function and range

To select measurement function and range:

1. Select the current measurement function by pressing the **MEAS** key as needed.
2. Enable autorange by pressing the **AUTO** key (the AUTO indicator lights). Alternatively, you can set manual ranging using the up or down RANGE keys.

Step 4: Turn output on

Turn the output on by pressing the **OUTPUT ON/OFF** control. The OUTPUT indicator light turns on.

Step 5: Observe readings on the display

Observe the readings on the display. Press the **TRIG** key if necessary to trigger the instrument to begin taking readings. The readings are on the top line, and source and limit values are on the bottom line. For the 100 M Ω resistor, typical display values are:

10.0000uA

SrcA: +1000.00V LimA:100.000uA

1. Press the **MEAS** key several times to display measured voltage, resistance, power, and current.

Typical values for the 100 M Ω resistor are

1000.00 V, 100.000 M Ω m, 10.000 mW, and 10.0000 uA.

Step 6: Turn output off

When finished, turn the output off by pressing the **OUTPUT ON/OFF** control. The OUTPUT indicator light will turn off.

Section 6

Measuring diode off-state breakdown

In this section:

Introduction	6-1
Equipment required.....	6-1
Set up communication.....	6-2
Device connections	6-3
Simple reverse voltage sweep	6-5
Advanced reverse voltage sweep	6-9

Introduction

This example demonstrates how to use the Model 2657A to measure the reverse breakdown characteristics of a high-voltage diode. The Model 2657A measures the leakage current as the reverse voltage is swept to the specified breakdown voltage of the diode.

There are two examples in this section. The first example demonstrates the simplest method. This method configures a sweep using a programmatic "for" loop.

The second example demonstrates a more advanced method for configuring this measurement by using the Model 2657A trigger model to run the sweep. This method is useful in the following situations:

- If you require very precise timing either for source or measurement.
- If you are using a Model 2657A in a multi-instrument setup and you need to receive or output trigger signals to other instruments or device handlers.

Equipment required

Equipment required:

- One Model 2657A High Power System SourceMeter® Instrument
- One GPIB or Ethernet cable to connect the Model 2657A to a computer
- One high voltage diode enclosed in a safe test fixture, such as the Keithley Instruments Model 8010 High Power Test Fixture Device
- Appropriate cabling to connect the Model 2657A to the test fixture

Set up communication

The communication setup is illustrated in the following figure. This application can be run using any of the supported communication interfaces for the instrument.

For additional detail about remote communications, see "Communications interfaces" in the Model 2657A Reference Manual.

Figure 25: Communication connections

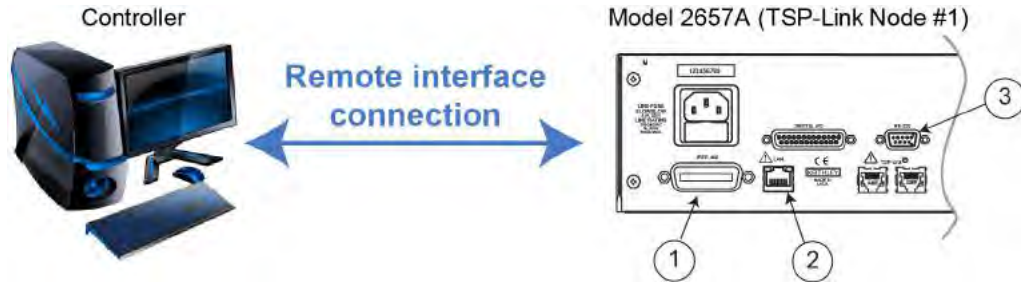

Item	Description	Qty	Notes
1	IEEE-488 connection	1	GPIB. Model 2657A is IEEE Std 488.1 compliant.
2	LAN connection	1	Model 2657A is LXI version 1.4 Core 2011 compliant. It supports TCP/IP and complies with IEEE Std 802.3 (ethernet). 10 or 100 Mbps. This is available from Keithley Instruments; see Model CA-180-3 LAN Crossover Cable.
3	RS-232 connection	1	Serial communication port.

Device connections

Refer to the following figure to connect the diode in a safe test fixture.

See [Safe configuration and test setup](#) (on page 2-1) for information on safely connecting the Model 2657A to a device under test (DUT).

Figure 26: Two-wire diode connections

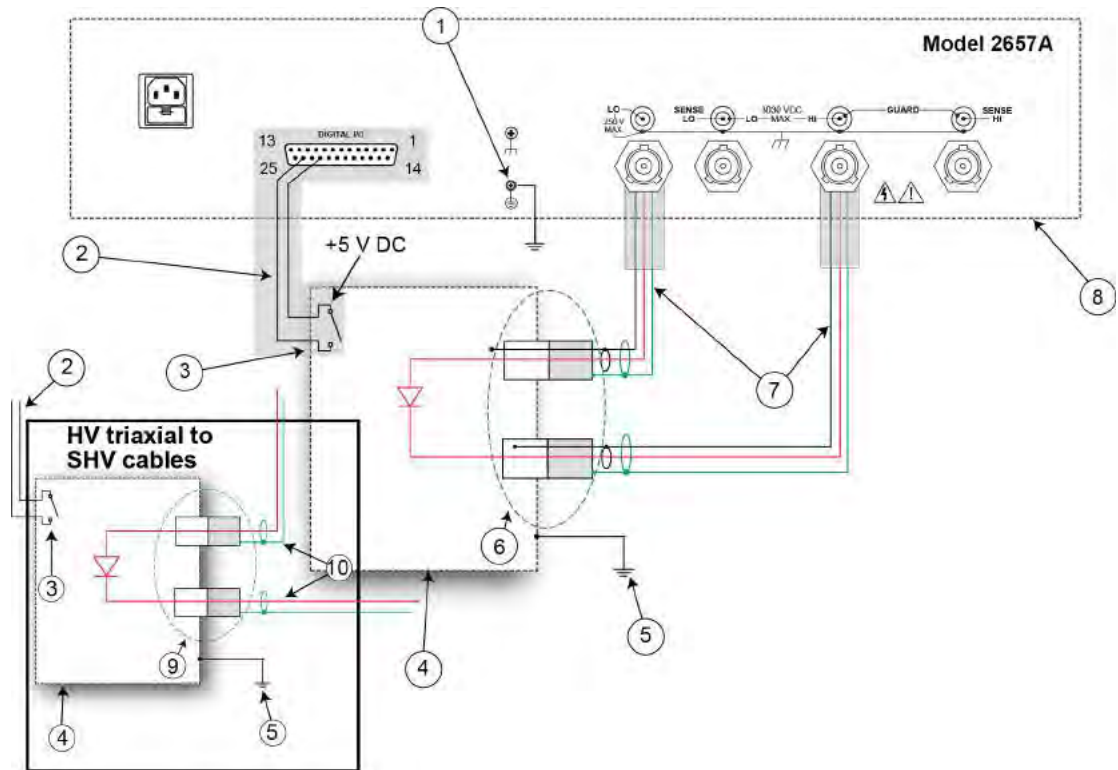

Item	Description	Qty	Notes
1	Model 2657A protective earth (safety ground)	1	Additional connections for redundant protective earth may be required. Keithley Instrument's Model CA-568 is a protective earth (safety ground) cable assembly.
2	Interlock connection	1	Model 2657A digital I/O; pin 24 (INT) and pin 22 (5 VDC) connected to the test fixture lid switch. Keithley Instrument's Model 7709-308 is a 25-pin interlock male connector that can be used for custom connections. Interlock switch is shown in the disengaged (lid open) position.
3	Test fixture interlock switch connection	1	
4	Interlocked metal safety enclosure	1	A safety enclosure with an interlock that has a normally-open (NO) switch.
5	Test fixture protective earth (safety ground)		Redundant grounds may be required for specific test setups.
6	Model HV-CA-571-3 High-Voltage Triaxial Panel-Mount Connector to Unterminated Cable Assembly	2	See Using high-voltage triaxial connectors (on page 2-7).
7	Model HV-CA-554 High-Voltage Triaxial Cable	2	
8	Model 2657A	1	
9	Panel-mount SHV connectors	2	Customer supplied.
10	Model SHV-CA-553 High-Voltage Triaxial to SHV Cable	2	

If you are using a Model 8010 High Power Test Fixture, see the Interconnect Reference Guide drawing "Two-terminal axial DUT with a Model 2657A connected" for connections and the Model 8010 User's Manual drawing "Model 2657A connections."

Figure 27: Two-wire diode physical connections

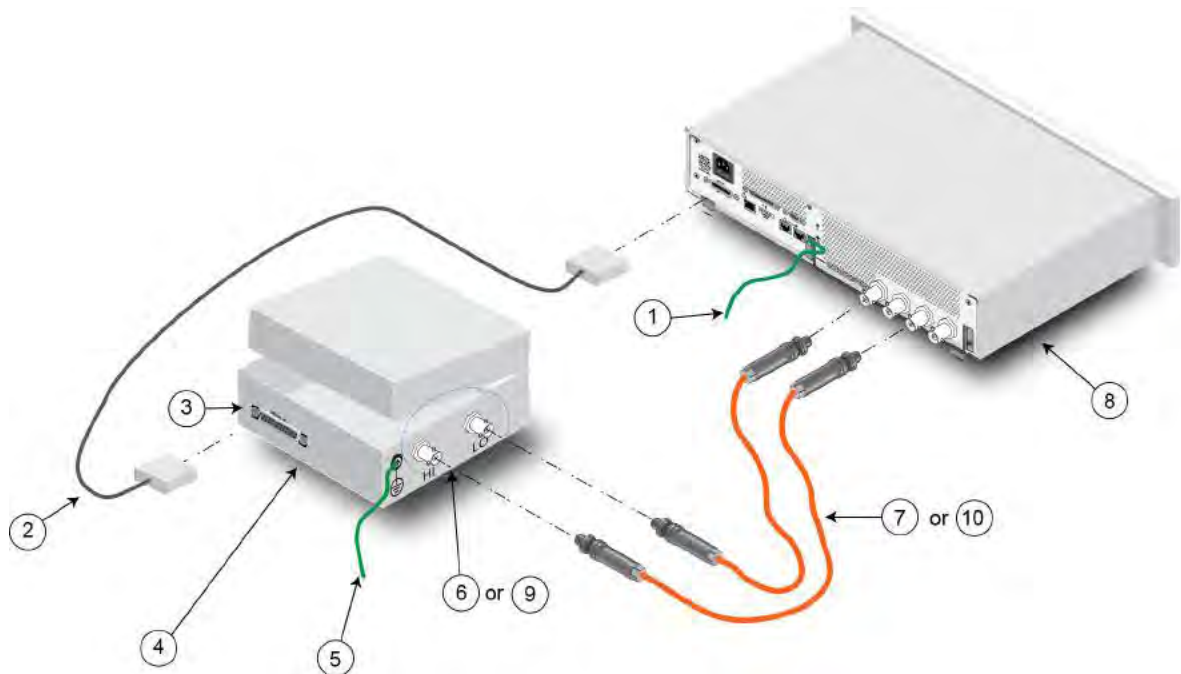

Simple reverse voltage sweep

NOTE

The example code is designed to be run from Test Script Builder or TSB Embedded. It can also be run from other programming environments, such as Microsoft® Visual Studio® or National Instruments LabVIEW™. However, you may need to make changes to the example code to use other programming environments.

This example demonstrates a simple method that you can use to configure and execute a reverse voltage sweep on a diode and collect current measurements.

This example uses a Test Script Processor (TSP®) script to perform the measurement. The script includes two separate functions that configure the System SourceMeter Instrument and return the raw current and voltage readings that are stored in the reading buffer.

The script is written using Test Script Processor (TSP) functions rather than as a single block of inline code. TSP functions are similar to functions in other programming languages, such as Microsoft® Visual C® or Visual Basic®. They must be called before the code in them is executed. Because of this, running the script alone will not execute the test. To execute the test, you need to run the script to load the functions into test script memory. You then call the functions.

Refer to the documentation for Test Script Builder or [TSB Embedded](#) (on page 4-4) for directions on how to run scripts and enter commands using the instrument console.

Example code

```
--[[
  DiodeRL(vstart, vstop, vstep, irange, ilimit)

  Description: This function uses a "for" loop to configure a
  reverse voltage sweep on a diode and collect leakage current
  measurements.

  This demonstrates a very simple method of performing a linear
  voltage sweep on the Model 2657A.

  Parameters:
  vstart: The starting voltage of the diode reverse voltage sweep.
  vstop: The stopping voltage of the diode reverse voltage sweep.
  vstep: The step voltage of the diode reverse voltage sweep
  (how much the voltage changes per step).
  irange: current measurement range, set to a value or set to
  "auto" to enable autorange.
  ilimit: The current limit of the voltage source.
```

```

Additional notes:
    Source delay is automatically added to each point of this sweep
    because the smua.source.levelv command is used.
    Source delay varies by voltage range.
    If the timing of the source is critical to your application,
    please use the DiodeRL_Swp function instead.

Example usage:
DiodeRL(0, 1000, 100, 100e-9, 0.01)
--]]

function DiodeRL(vstart,vstop,vstep,irange,ilimit)

    --Reset and initialize instrument.
    reset()
    status.reset()
    errorqueue.clear()

    --Configure source function as 2W DCVOLTS.
    smua.source.func = smua.OUTPUT_DCVOLTS
    smua.sense = smua.SENSE_LOCAL

    --Define local variable to store the number of points in the sweep.
    local l_numPoints

    --[[
        Calculate the number of points based on the start and
        stop values of the sweep.
    --]]
    if math.abs(vstart) > math.abs(vstop) then
        smua.source.rangev = vstart
        l_numPoints = (vstart - vstop) / vstep + 1
    else
        smua.source.rangev = vstop
        l_numPoints = (vstop - vstart) / vstep + 1
    end

    --Set up current compliance.
    smua.source.limiti = ilimit

    --Sets up current range.
    if irange == "auto" then
        smua.measure.autorangei = smua.AUTORANGE_ON
    else
        smua.measure.autorangei = smua.AUTORANGE_OFF
        smua.measure.rangei = irange
    end

    --Set the measurement integration time.
    smua.measure.nplc = 1
    smua.measure.delay = 0.05

```

```

--Configure the reading buffers.
smua.nvbuffer1.clear()
smua.nvbuffer1.appendmode = 1
smua.nvbuffer1.collecttimestamps = 1
smua.nvbuffer1.collectsourcevalues = 0
smua.nvbuffer1.fillmode = smua.FILL_ONCE
smua.nvbuffer2.clear()
smua.nvbuffer2.appendmode = 1
smua.nvbuffer2.collecttimestamps = 1
smua.nvbuffer2.collectsourcevalues = 0
smua.nvbuffer2.fillmode = smua.FILL_ONCE

--Define local variable for index of the "for" loop.
local l_i

--Turn on the output.
smua.source.output = 1

--[
    Use a "for" loop to run the linear voltage sweep and
    make current and voltage measurements.
--]
for l_i = 0, (l_numPoints-1) do
    --Update the source level.
    smua.source.levelv = vstart + l_i*(vstep)
    --Make simultaneous voltage and current measurements.
    smua.measure.iv(smua.nvbuffer1, smua.nvbuffer2)
end
--Set the voltage level back to 0 V.
smua.source.levelv = 0

--Turn off the output.
smua.source.output = 0
end

--[
    This function prints the data from the smua.nvbuffer1 and
    smua.nvbuffer2 reading buffers into three separate
    tab-delimited columns.
--]
function printData()
    if smua.nvbuffer1.n == 0 then
        print("No readings in buffer")
    else
        print("Timestamps\tCurrent\tVoltage")
        for i = 1, smua.nvbuffer1.n do
            print(string.format("%g\t%g\t%g", smua.nvbuffer1.timestamps[i],
                smua.nvbuffer1.readings[i], smua.nvbuffer2.readings[i]))
        end
    end
end
end

```

Example usage

The functions in this script allow updates to the test parameters without rewriting or re-running the script. To run the test, call the `DiodeRL()` function, passing in the appropriate values for test parameters.

DiodeRL() parameters		
Parameter	Units	Description
<code>vstart</code>	volts	Start voltage for the linear voltage sweep
<code>vstop</code>	volts	Stop voltage for the linear voltage sweep
<code>vstep</code>	volts	Step voltage for the sweep
<code>irange</code>	current	Current measurement range
<code>ilimit</code>	current	Current limit (compliance)

An example of how to call this function is shown here:

```
DiodeRL(0, 1000, 10, 100e-9, 0.01)
```

This call results in a 101-point linear voltage sweep starting at 0 V and proceeding to 1000 V in 10 V increments. The current measurement range is set to 100 nA and the current limit is set to 10 mA.

You can use the `printData()` function to return the stored voltage and current measurements and the timestamps. The data is formatted into three columns. Here is an example of how to call the `printData()` function:

```
printData()
```

An example of the output is shown here.

NOTE

The connections that were made to the device were set up so that when a positive voltage was sourced, the device was reverse biased. The voltage readings were negated before graphing.

Figure 28: Results of sample data for diode breakdown characteristics

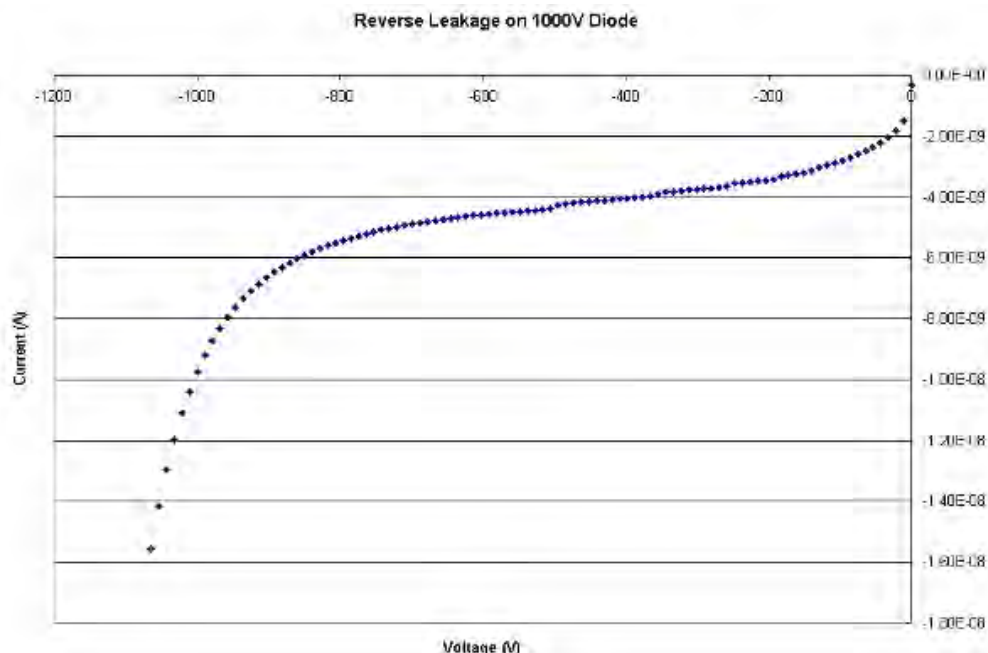

Advanced reverse voltage sweep

This example demonstrates how to use the trigger model of the Model 2657A to perform a reverse linear voltage sweep on a diode and collect current measurements. The trigger model is useful when critical timing is required or when the Model 2657A must send or receive triggers from an external instrument or device handler.

This example does not configure any incoming or outgoing trigger signals. For more information on the trigger model, see the Model 2657A Reference Manual.

Example code

```
--[[
  DiodeRL_Swp(vstart, vstop, vstep, irange, ilimit, sourceDelay)

  Description: This function uses the trigger model and built-in
  sweeping function to create a linear voltage sweep to measure
  the reverse leakage of a diode.

  Using this method is useful when there is a need to send or
  receive external triggers from another instrument or
  device handler.

  Parameters:
  vstart: The starting voltage of the diode reverse voltage sweep.
  vstop: The stopping voltage of the diode reverse voltage sweep.
  vstep: The step voltage of the diode reverse voltage sweep
  (how much the voltage changes per step).
  irange: current measurement range, set to value or set to "auto"
  to enable autorange.
  ilimit: The current limit of the voltage source.
  sourceDelay: The delay between the start of source and the
  source complete event.

  Example usage:
  DiodeRL_Swp(0, 1000, 10, 100e-9, 0.01, 0.05)
--]]

function DiodeRL_Swp(vstart,vstop,vstep,irange,ilimit,sourceDelay)

  --Reset and initialize instrument.
  reset()
  status.reset()
  errorqueue.clear()

  --Configure source function as 2W DCVOLTS
  smua.source.func = smua.OUTPUT_DCVOLTS
  smua.sense = smua.SENSE_LOCAL

  --Define a local variable to store the number of points in the sweep.
  local l_numPoints
```

```

--[[
    Calculate the number of points in the sweep based on the
    start and stop values.
--]]
if math.abs(vstart) > math.abs(vstop) then
    smua.source.rangev = vstart
else
    smua.source.rangev = vstop
end
l_numPoints = math.abs((vstop - vstart) / vstep) + 1
--Set up source delay.
smua.source.delay = sourceDelay

--Set up current compliance.
smua.source.limiti = ilimit

--Set up current measurement range.
if irange == "auto" then
    smua.measure.autorangei = smua.AUTORANGE_ON
else
    smua.measure.autorangei = smua.AUTORANGE_OFF
    smua.measure.rangei = irange
end

--Set the integration time.
smua.measure.nplc = 1

--Configure the reading buffers.
smua.nvbuffer1.clear()
smua.nvbuffer1.appendmode = 0
smua.nvbuffer1.collecttimestamps = 1
smua.nvbuffer1.collectsourcevalues = 0
smua.nvbuffer1.fillmode = smua.FILL_ONCE
smua.nvbuffer2.clear()
smua.nvbuffer2.appendmode = 0
smua.nvbuffer2.collecttimestamps = 1
smua.nvbuffer2.collectsourcevalues = 0
smua.nvbuffer2.fillmode = smua.FILL_ONCE

--Configure the source sweep.
smua.trigger.source.linearv(vstart, vstop, l_numPoints)
smua.trigger.source.action = smua.ENABLE
smua.trigger.source.stimulus = 0

--Configure measurements during the sweep.
smua.trigger.measure.action = smua.ENABLE
smua.trigger.measure.stimulus = 0
smua.trigger.measure.iv(smua.nvbuffer1, smua.nvbuffer2)

--Configure trigger model parameters.
smua.trigger.count = l_numPoints
smua.trigger.arm.count = 1

--Turn on the output.
smua.source.output = 1

```

```

--[[
    Initiate the sweep and wait until sweep is complete before
    proceeding to next command.
--]]
smua.trigger.initiate()
waitcomplete()

--Turn off the output.
smua.source.output = 0

end

--[[
    This function prints the data from the smua.nvbuffer1 and
    smua.nvbuffer2 reading buffers into three separate columns.
--]]
function printData()
    if smua.nvbuffer1.n == 0 then
        print("No readings in buffer")

    else
        print("Timestamps\tCurrent\tVoltage")
        for i = 1, smua.nvbuffer1.n do
            print(string.format("%g\t%g\t%g",
                smua.nvbuffer1.timestamps[i], smua.nvbuffer1.readings[i],
                smua.nvbuffer2.readings[i]))
        end
    end
end
end
end

```

Example usage

The functions in this script allow updates to the test parameters without rewriting or re-running the script. To run the test, call the `DiodeRL_Swp()` function, passing in the appropriate values for test parameters.

DiodeRL_Swp() parameters		
Parameter	Units	Description
<code>vstart</code>	volts	Start voltage for the linear voltage sweep
<code>vstop</code>	volts	Stop voltage for the linear voltage sweep
<code>vstep</code>	volts	Step voltage for the sweep
<code>irange</code>	current	Current measurement range
<code>ilimit</code>	current	Current limit (compliance)
<code>sourceDelay</code>	seconds	The delay between the source complete event and the start of the measurement

An example of how to call this function is shown here:

```
DiodeRL_Swp(0, 1000, 10, 100e-9, 0.01, 0.05)
```

This call results in a 101-point linear voltage sweep starting at 0 V and proceeding to 1000 V in 10 V increments. The current measurement range is set to 100 nA and the current limit is set to 10 mA. A 50 ms delay occurs after each source step is programmed. The source complete event of the trigger model is held off until that delay is complete. Once the delay, and therefore the source event, is complete, the measure action can take place.

For more information on the trigger model, please see the Model 2657A Reference Guide.

You can use the `printData()` function to return the stored voltage and current measurements and the timestamps. The data is formatted into three columns. An example of how to call the `printData()` function is:

```
printData()
```

The results of this test are the same as those produced by the simple reverse voltage sweep. See [Simple reverse voltage sweep](#) (on page 6-5) for a graph of the results.

Measuring capacitor leakage

In this section:

Introduction	7-1
Equipment required.....	7-1
Set up communication.....	7-2
Device connections	7-2
Measuring leakage current and insulation resistance	7-4

Introduction

This example demonstrates how to use the Model 2657A High Power System SourceMeter[®] Instrument to measure the leakage current and calculate the insulation resistance of a capacitor.

In this example:

1. The capacitor is charged to the desired voltage.
2. The voltage is held across the capacitor for a user-specified amount of time.
3. The current is measured.
4. The Model 2657A discharges the capacitor using the programmed current limit.

Equipment required

Equipment required:

- One Model 2657A High Power System SourceMeter[®] Instrument
- One GPIB or Ethernet cable to connect the Model 2657A to a computer
- One high voltage capacitor enclosed in a safe test fixture, such as the Keithley Instruments Model 8010
- Appropriate cabling to connect the Model 2657A to the test fixture

Set up communication

The communication setup is illustrated in the following figure. This application can be run using any of the supported communication interfaces for the instrument.

For additional detail about remote communications, see "Communications interfaces" in the Model 2657A Reference Manual.

Figure 29: Communication connections

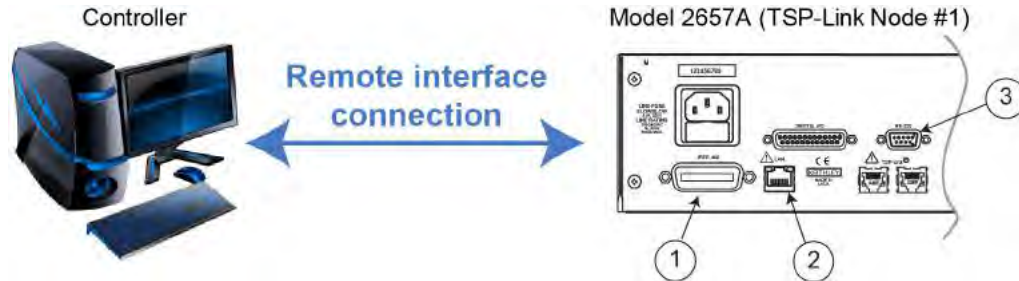

Item	Description	Qty	Notes
1	IEEE-488 connection	1	GPIB. Model 2657A is IEEE Std 488.1 compliant.
2	LAN connection	1	Model 2657A is LXI version 1.4 Core 2011 compliant. It supports TCP/IP and complies with IEEE Std 802.3 (ethernet). 10 or 100 Mbps. This is available from Keithley Instruments; see Model CA-180-3 LAN Crossover Cable.
3	RS-232 connection	1	Serial communication port.

Device connections

Refer to the following figure to connect the capacitor in a safe test fixture.

See [Safe configuration and test setup](#) (on page 2-1) for information on safely connecting the Model 2657A to a device under test (DUT).

For connections if you are using a Model 8010 High Power Test Fixture, see the Interconnect Reference Guide drawing "Two-terminal axial DUT with a Model 2657A connected" and the Model 8010 User's Manual drawing "Model 2657A connections."

Figure 30: Two-wire capacitor connections

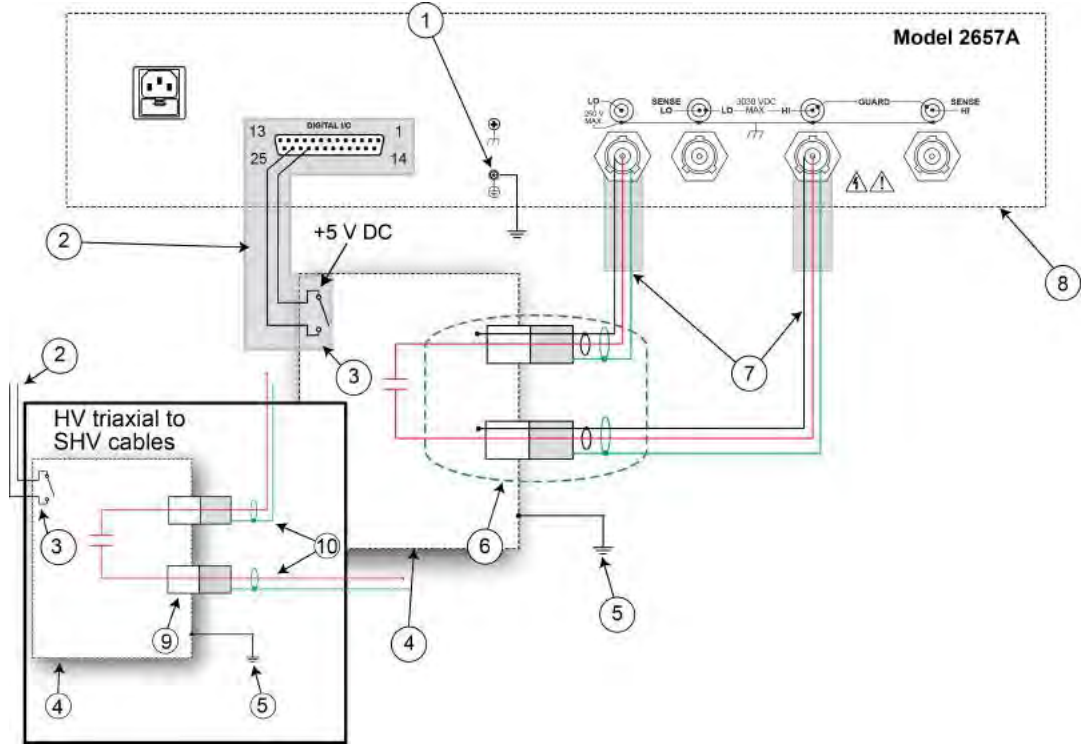

Item	Description	Qty	Notes
1	Model 2657A protective earth (safety ground)	1	Additional connections for redundant protective earth may be required. Keithley Instrument's Model CA-568 is a protective earth (safety ground) cable assembly.
2	Interlock connection	1	Model 2657A digital I/O; pin 24 (INT) and pin 22 (5 VDC) connected to the test fixture lid switch. Keithley Instrument's Model 7709-308 is a 25-pin interlock male connector that can be used for custom connections. Interlock switch is shown in the disengaged (lid open) position.
3	Test fixture interlock switch connection	1	
4	Interlocked metal safety enclosure	1	A safety enclosure with an interlock that has a normally-open (NO) switch.
5	Test fixture protective earth (safety ground)	1	Additional connections for redundant grounds may be required for specific test setups.
6	Model HV-CA-571-3 High-Voltage Triaxial Panel-Mount Connector to Unterminated Cable Assembly	2	See Using high-voltage triaxial connectors (on page 2-7).
7	Model HV-CA-554 High-Voltage Triaxial Cable	4	
8	Model 2657A	1	
9	Panel-mount SHV connectors	2	Customer-supplied.
10	Model SHV-CA-553 High-Voltage Triaxial to SHV Cable	2	

Figure 31: Two-wire capacitor physical connections

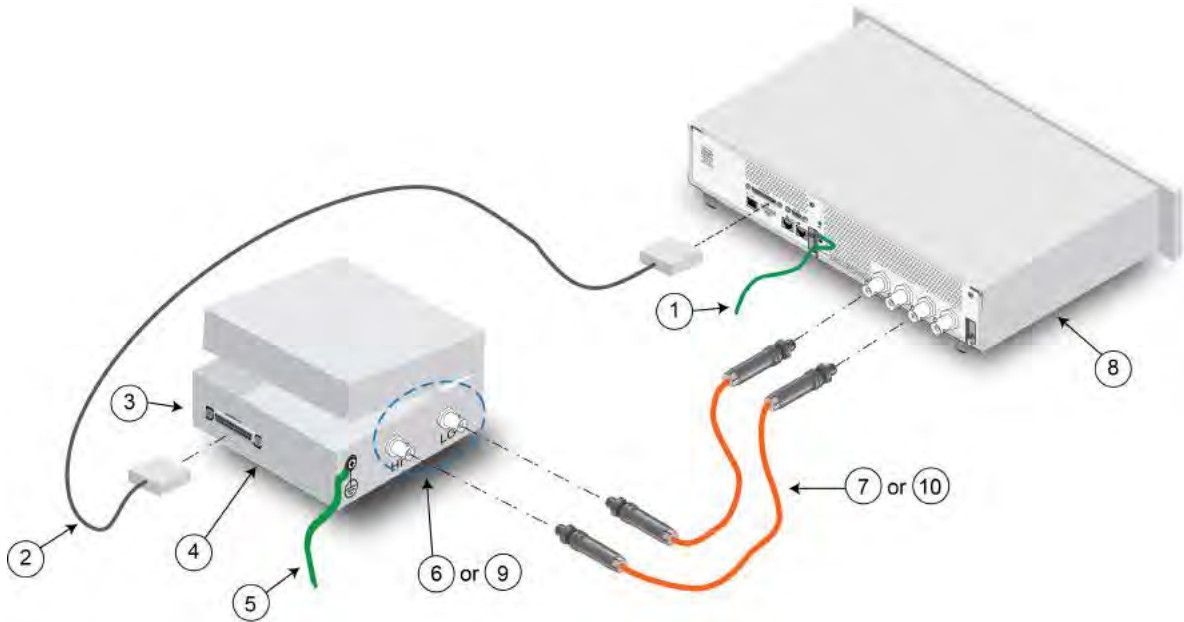

Measuring leakage current and insulation resistance

NOTE

The example code is designed to be run from Test Script Builder or TSB Embedded. It can also be run from other programming environments, such as Microsoft® Visual Studio® or National Instruments LabVIEW™. However, you may need to make changes to the example code to use other programming environments.

This example demonstrates a simple method for measuring the leakage current and insulation resistance of a capacitor. This example uses a TSP script to perform the measurement. The script includes two separate functions for configuring the System SourceMeter Instrument and returning the raw current and voltage readings from the reading buffer.

The script is written using TSP functions rather than as a single block of inline code. TSP functions are similar to functions in other programming languages, such as Microsoft® Visual C® or Visual Basic®. They must be called before the code in them is executed. Because of this, running the script alone will not execute the test. To execute the test, you need to run the script to load the functions into test script memory. You then call the functions.

Refer to the documentation for Test Script Builder or TSB Embedded for directions on how to run scripts and enter commands using the instrument console.

Example code

```
function runCapLeak(testV, iLimit, measRange, numReadings, soakTime, numNPLC)

--Initialize SMU.
reset()
errorqueue.clear()
status.reset()
```

```

--Configure reading buffers.
smua.nvbuffer1.clear()
smua.nvbuffer1.appendmode = 0
smua.nvbuffer1.collecttimestamps = 1
smua.nvbuffer1.collectsourcevalues = 0

smua.nvbuffer2.clear()
smua.nvbuffer2.appendmode = 0
smua.nvbuffer2.collecttimestamps = 1
smua.nvbuffer2.collectsourcevalues = 0

--Configure source function.
smua.source.func = smua.OUTPUT_DCVOLTS
smua.source.levelv = testV
smua.source.limiti = iLimit

--[
Configure measurement parameters. Each call of the measurement function
will result in the number of readings specified by smua.measure.count.
The time specified by smua.measure.delay is enforced before any
measurements are made.
--]
smua.measure.autozero = smua.AUTOZERO_ONCE
smua.measure.rangei = measRange
smua.measure.count = numReadings
smua.measure.nplc = numNPLC
smua.measure.delay = soakTime

--[
Run the test.
Turn on the output. The programmed voltage is output immediately.
--]
smua.source.output = 1
--[
Perform a set of current and voltage measurements. Measure delay is enforced before
measurements are made.
--]
smua.measure.iv(smua.nvbuffer1, smua.nvbuffer2)
--[
After measurements are complete, return the voltage to 0 V. The rate of discharge
is limited by programmed current limit.
--]
smua.source.levelv = 0
--[
Wait until the capacitor is fully discharged before turning off
the output.
--]
delay(soakTime)
smua.source.output = 0

end

```

```
--[[
  This function prints the raw voltage and current measurements that
  are stored in reading buffers smua.nvbuffer1 and smua.nvbuffer2
--]]

function printData()
  --Retrieve average values of measured current and voltage.
  current_stats = smua.buffer.getstats(smua.nvbuffer1)
  voltage_stats = smua.buffer.getstats(smua.nvbuffer2)
  current_mean = current_stats.mean
  voltage_mean = voltage_stats.mean

  --Calculate the insulation resistance of the capacitor.
  resistance = voltage_mean/current_mean
  --Print the summary of the results to the communication interface.
  print(string.format("Average current: %g", current_mean))
  print(string.format("Average voltage: %g", voltage_mean))
  print(string.format("Insulator Resistance: %g", resistance))

  if smua.nvbuffer1.n == 0 then
    print("No reading in buffer")
  else
    print("Timestamps\tCurrent\tVoltage")
    for i = 1, smua.nvbuffer1.n do
      print(string.format("%g\t%g\t%g", smua.nvbuffer1.timestamps[i],
        smua.nvbuffer1.readings[i], smua.nvbuffer2.readings[i]))
    end
  end
end
end
```

Example usage

The functions in this script allow updates to the test parameters without rewriting or re-running the script. To run the test, call the `runCapLeak()` function, passing in the appropriate values for test parameters.

runCapLeak() parameters		
Parameter	Units	Description
testV	volts	The voltage level to test the capacitor with.
iLimit	amps	Current limit (compliance) for the test. This limits the rate of charge and discharge of the capacitor
measRange	amps	Current measurement range to be used for leakage current measurement.
numReadings	not applicable	The number of measurements to make after the soak time elapses; this is the number of readings used to calculate the mean value.
soakTime	seconds	Amount of time to apply the voltage before taking a measurement.
numNPLC	not applicable	Integration time, specified as the number of power line cycles.

An example of how to call this function is as follows:

```
runCapLeak(2000, 1e-3, 10e-9, 10, 30, 1)
```

This call results in the charge of the capacitor under test to 2000 V. The rate of charge of the capacitor is limited by the 1 mA current limit. The soak time starts after the voltage source is programmed and elapses after 30 seconds. Once the soak time has completed, 10 current measurements are made on the 10 nA range at a 1 PLC integration rate. After all measurements are complete, the voltage source is again programmed to 0 V and the discharge is limited by the 1 mA current limit. The soak time is again enforced to ensure adequate time to discharge the capacitor, then the output is turned off.

You can use the `printData()` function to return the voltage and current measurements and the timestamps that are stored in the buffer. The data is formatted into three columns. To call the `printData()` function, send:

```
printData()
```

An example of the summary of results that print is:

```
Average current: 1.62033e-09
Average voltage: 1999.9
Insulator Resistance: 1.23426e+12
Timestamps Current Voltage
0 1.65E-09 1999.9
0.016698 1.65E-09 1999.9
0.033397 1.63E-09 1999.9
0.050095 1.62E-09 1999.9
0.066793 1.63E-09 1999.9
0.083492 1.64E-09 1999.9
0.10019 1.62E-09 1999.9
0.116889 1.59E-09 1999.9
0.133587 1.57E-09 1999.9
0.150286 1.59E-09 1999.9
```

Sample data is shown in the following graphics. The first graphic shows a typical capacitor leakage curve. The second graphic shows the data that is actually returned by this example. If you were to capture the complete current to time profile of the leakage current, the data shown in the second graphic would occur further out on the x-axis of the first graphic.

Figure 32: Typical capacitor leakage curve

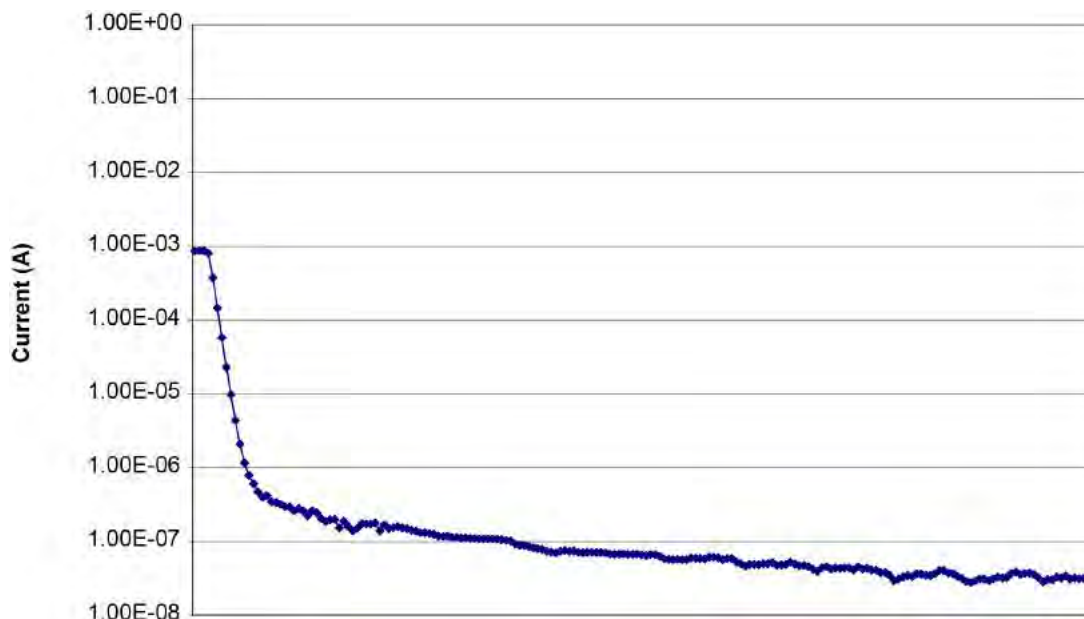
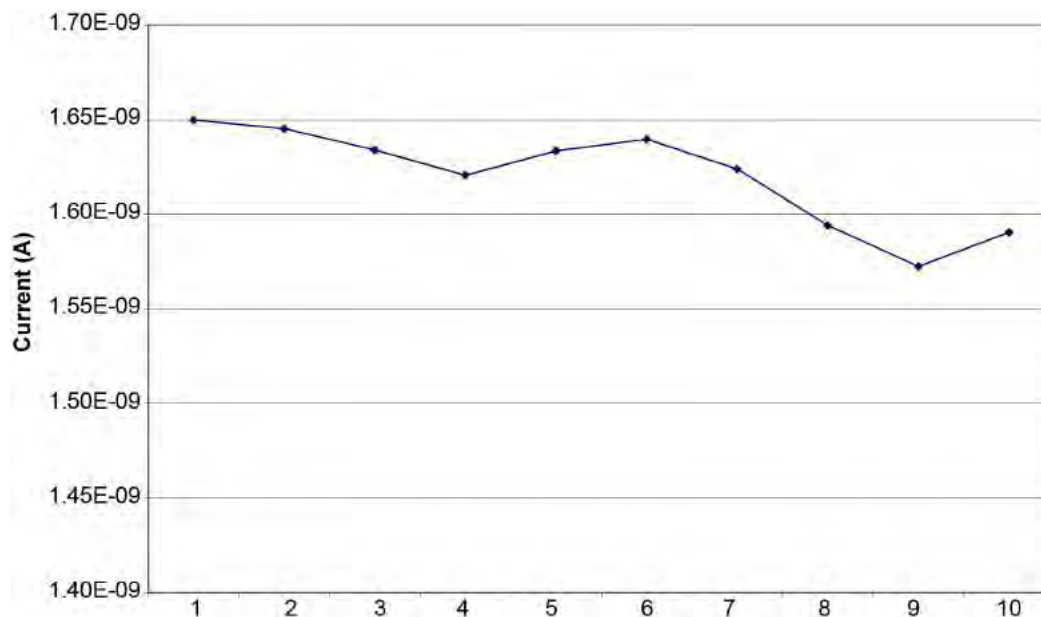

Figure 33: Sample data for capacitor leakage test



NOTE

The Model 2657A voltage source is stable into capacitance values of up to 10 μF typical on the 1500 V and 3000 V ranges. See the latest Model 2657A specifications on the Keithley Instruments website for detail. However, if noisy current measurements or voltage source oscillation occurs, try inserting a resistor or low leakage diode in series with the capacitor. See the application note "Capacitor Leakage Measurements with a Model 6517A Electrometer" on the [Keithley Instruments website](http://www.keithley.com) (<http://www.keithley.com>) for more detail.

Measuring MOSFET characteristics

In this section:

Introduction	8-1
Equipment required.....	8-1
Set up communication.....	8-2
Device connections	8-3
BV _{dss} measurement.....	8-6
I _{dss} measurement.....	8-9

Introduction

These examples demonstrate how to use the Model 2657A High Power System SourceMeter[®] Instrument to measure drain-to-source breakdown and leakage current of a MOSFET.

There are two examples in this section. The first example performs the BV_{dss} measurement, in which a specific current is forced from the drain to the source terminals (I_d) and a voltage measurement is performed (V_{ds}).

The second example performs the I_{dss} measurement in which the Model 2657A sweeps the drain voltage (V_{ds}) and makes drain-current measurements with the FET in the off-state.

In both examples, a second System SourceMeter Instrument is used to apply a voltage from gate to source (V_{gs}). For n-channel, enhancement mode devices, V_{gs} is usually 0 V.

Equipment required

Equipment required:

- One Model 2657A High Power System SourceMeter[®] Instrument
- One Series 2600A System SourceMeter Instrument (Model 2611A, Model 2612A, Model 2635A, or Model 2636A)
 - If needed, cables to connect the Series 2600A SourceMeter Instrument to the protection module
 - If needed, cables to connect the protection module to the test fixture
 - If a Model 2611A or Model 2612A is being used, one Model 2600-TRIAx adapter
- If you are not using a Model 8010 High Power Device Test Fixture, you need a Model 2657A-PM-200 Protection Module to ensure that the lower voltage Series 2600A SourceMeter Instrument is protected if the device under test fails
- One GPIB or Ethernet cable to connect the Model 2657A to a computer
- One high voltage MOSFET device enclosed in a safe test fixture, such as the Keithley Instruments Model 8010
- Appropriate cabling to connect the Model 2657A the test fixture

Set up communication

The communication setup is illustrated in the following diagram. This application can be run using any of the supported communication interfaces for the instruments.

For additional detail about remote communications, see "Communications interfaces" in the Model 2657A Reference Manual.

Figure 34: Remote interface and TSP-Link communications setup

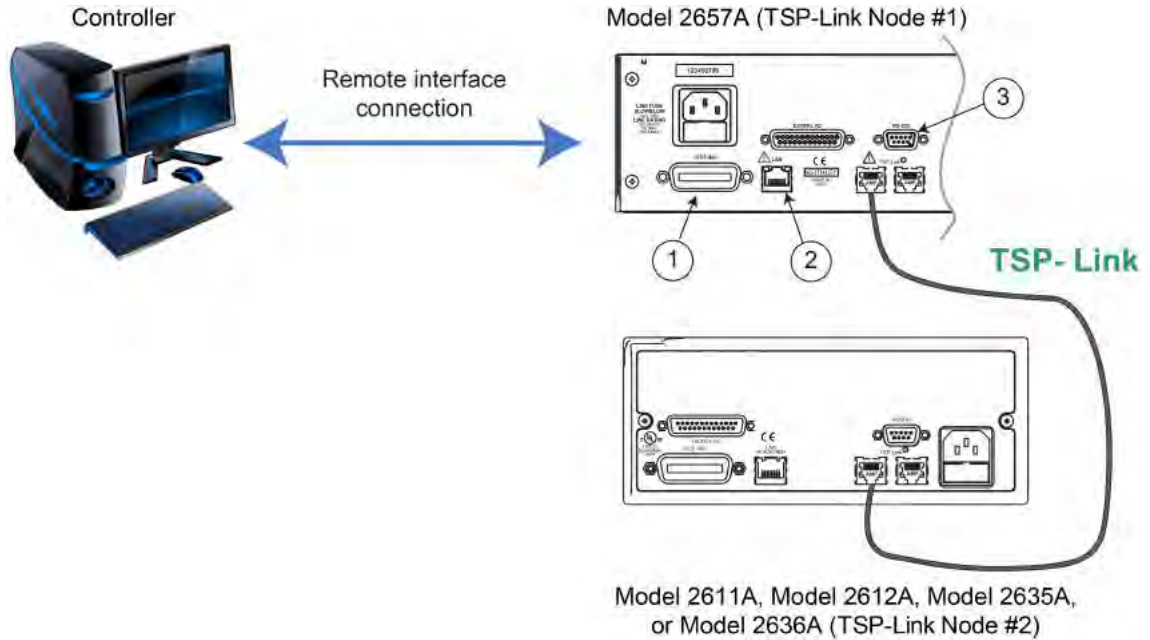

Item	Description	Qty	Notes
1	IEEE-488 connection	1	GPIB. Model 2657A is IEEE Std 488.1 compliant.
2	CA-180-3	1	Model 2657A is LXI version 1.4 Core 2011 compliant. It supports TCP/IP and complies with IEEE Std 802.3 (ethernet). 10 or 100 Mbps. This is available from Keithley Instruments; see Model CA-180-3 LAN Crossover Cable.
3	RS-232 connection	1	Serial communication port.

To set the TSP-Link node number using the front-panel interface:

1. Press the **MENU** key.
2. Select **TSPLink**.
3. Select **NODE**.
4. Use the navigation wheel  to adjust the node number.
5. Press the **ENTER** key to save the TSP-Link node number.

On the Model 2657A SMU #1 (TSP-Link node #1), perform a TSP-Link reset to update it with the linked instruments:

1. Press the **MENU** key.
2. Select **TSPLink**.
3. Select **RESET**.

NOTE

If error 1205 is generated during the TSP-link reset, ensure that the Series Model 2657A has a unique TSP-Link node number.

Quick Tip

You can also perform a TSP-Link reset from the remote command interface by sending `tsplink.reset()` to the Model 2657A. This method is used in the example program.

Device connections

Refer to the following figure to connect the MOSFET in a safe test fixture.

See [Safe configuration and test setup](#) (on page 2-1) for information on safely connecting the Model 2657A to a device under test (DUT).



CAUTION

If a device under test fails, high voltage may be present at a terminal to which Series 2600A instruments are connected. This could damage a Series 2600A instrument. To prevent damage to the Series 2600A instrument, use a Model 2657A-PM-200 Protection Module. Failure to use a protection module could result in equipment damage.

Figure 35: Schematic for measuring MOSFET characteristics application example

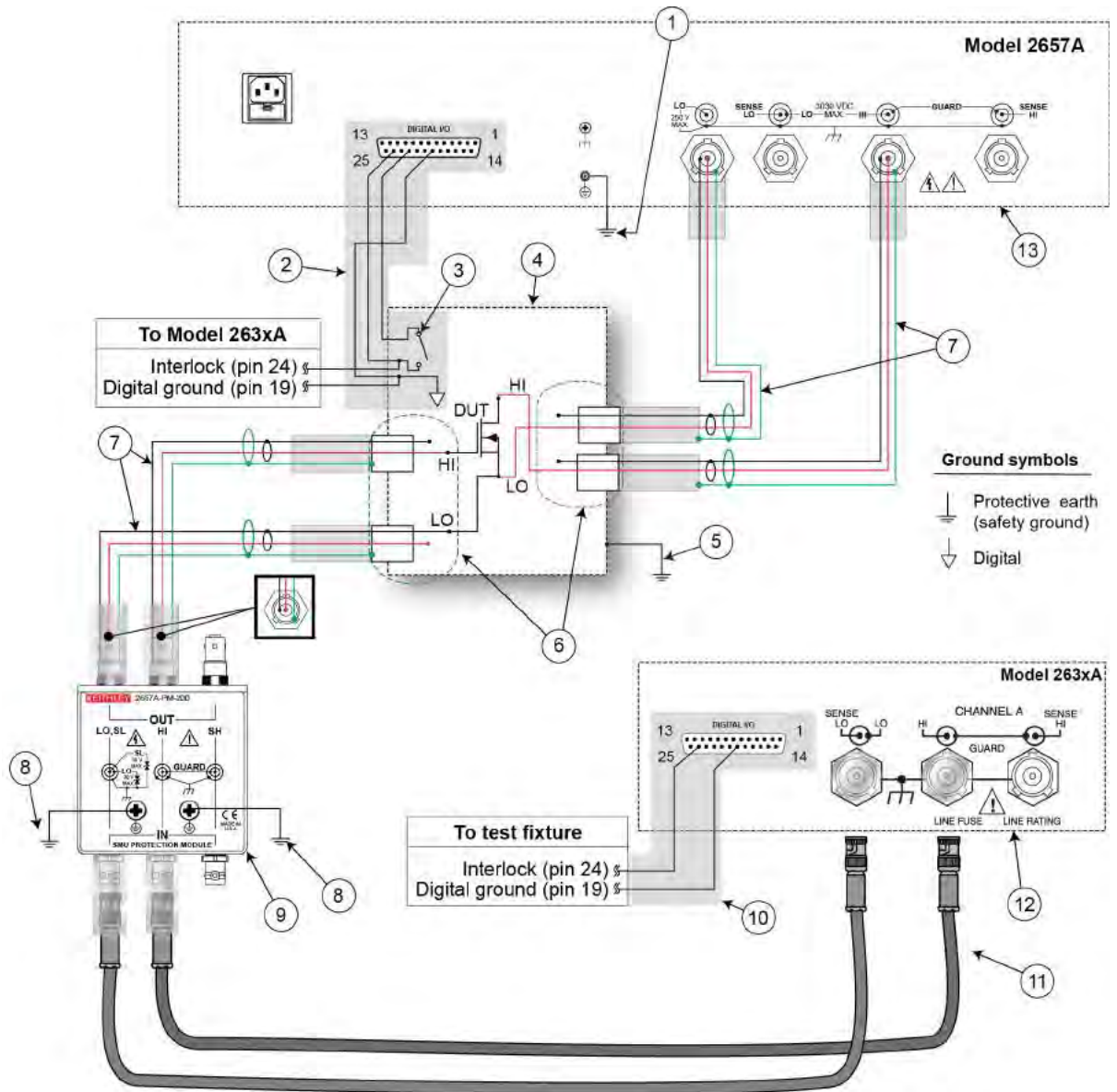

Item	Description	Qty	Notes
1	Model 2657A protective earth (safety ground)	1	Additional connections for redundant protective earth may be required. Keithley Instrument's Model CA-568 is a protective earth (safety ground) cable assembly.
2	Model 2657A interlock connection	1	Model 2657A digital I/O; pin 24 (INT) and pin 22 (5 VDC) connected to the test fixture lid switch. Pin 24 and pin 19 are connected to the interlock and digital ground on the Model 263xA. Keithley Instrument's Model 7709-308 is a 25-pin interlock male connector that can be used for custom connections. Interlock switch is shown in the disengaged (lid open) position.
3	Test fixture interlock switch connection	1	
4	Interlocked metal safety enclosure	1	A safety enclosure with an interlock that has a normally-open (NO) switch.
5	Test fixture protective earth (safety ground)	1	Redundant grounds may be required for specific test setups.
6	Model HV-CA-571-3 High-Voltage Triaxial Panel-Mount Connector to Unterminated Cable Assembly	4	See Using high-voltage triaxial connectors (on page 2-7).
7	Model HV-CA-554 HV Triaxial Cable	4	
8	Protective earth (safety ground) for the Model 2657A-PM-200 Protection Module	2	The Model 2657A-PM-200 must be connected to protective earth using the supplied green-yellow ground cables (Model CA-568).
9	Model 2657A-PM-200 Protection Module	1	
10	Model 2611A, 2612A, 2635A or 2636A interlock connection	1	Pin 24 (INT) and pin 19 (5 V DC) are connected to the test fixture lid switch.
11	Model 7078-TRX triaxial cables	2	
12	Series 2600A System SourceMeter Instrument (Model 2611A, Model 2612A, Model 2635A, or Model 2636A)	1	If a Model 2611A or 2612A is used, a Model 2600-TRIAX adapter is also required
13	Model 2657A	1	

If you are using a Model 8010 High Power Test Fixture, see the Interconnect Reference Guide drawing "Three-terminal DUT with a Model 2657A. Also see the Model 8010 User's Manual for information on how to connect the instrument to the fixture.

Figure 36: Measuring MOSFET characteristics application example connections

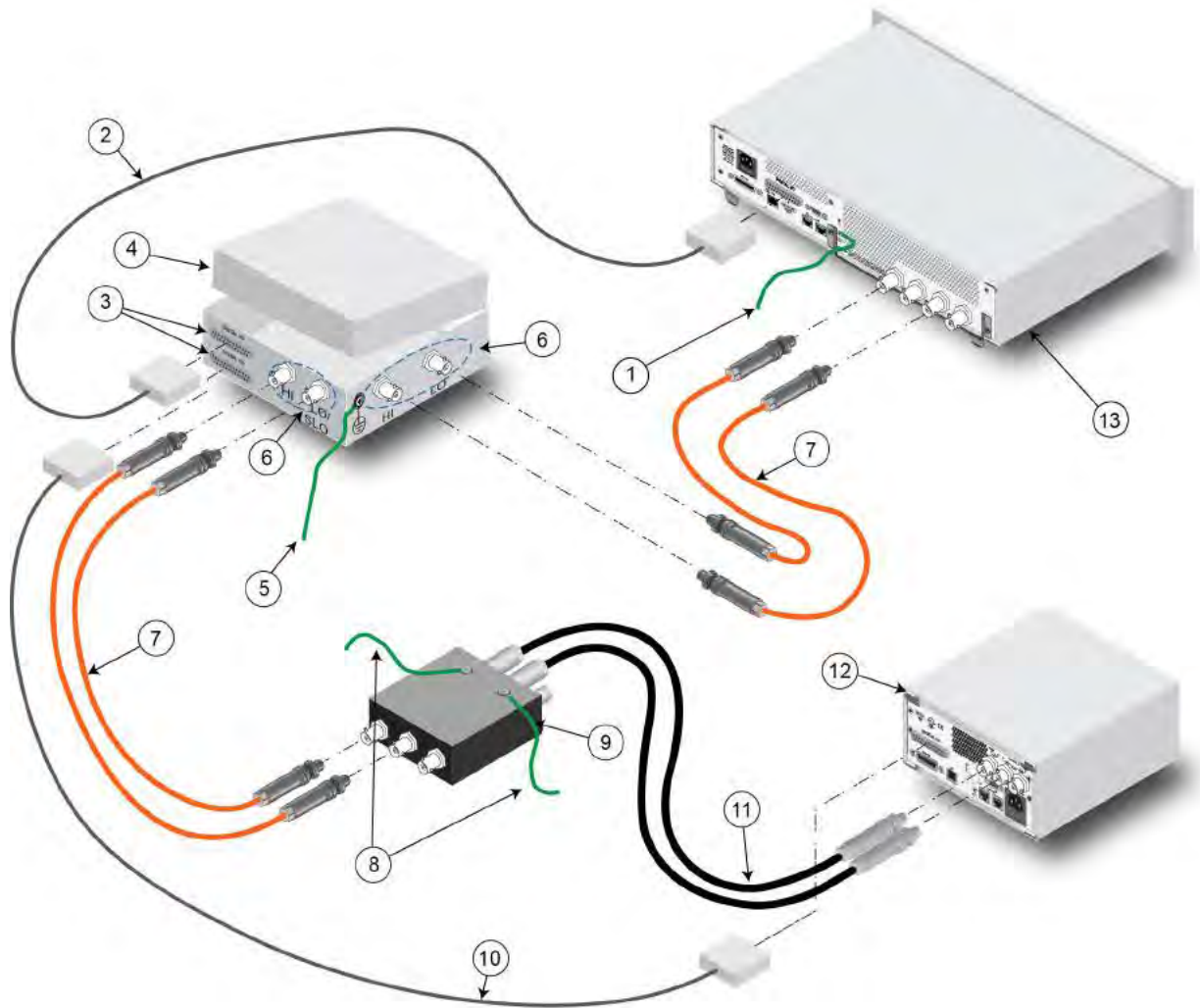

BV_{dss} measurement

NOTE

The example code is designed to be run from Test Script Builder or TSB Embedded. It can also be run from other programming environments, such as Microsoft® Visual Studio® or National Instruments LabVIEW™. However, you may need to make changes to the example code to use other programming environments.

This example performs the BV_{dss} measurement. The Model 2657A forces a current from the drain to source terminals and measures the resulting V_{ds} . This example uses a TSP script to perform the measurement. The script includes two separate functions for configuring the System SourceMeter Instrument and returning the raw current and voltage readings from the reading buffer.

The script is written using Test Script Processor (TSP) functions rather than as a single block of inline code. TSP functions are similar to functions in other programming languages, such as Microsoft® Visual C® or Visual Basic®. They must be called before the code in them is executed. Because of this, running the script alone will not execute the test. To execute the test, you need to run the script to load the functions into test script memory. You then call the functions.

Refer to the documentation for Test Script Builder or [TSB Embedded](#) (on page 4-4) for directions on how to run scripts and enter commands using the instrument console.

Example code

```
--[[
  Title: FET Drain-Source Breakdown Voltage
  Description: This script measures the drain-source
  breakdown voltage (BVdss) of a FET.
--]]

--[[
  BVdss(gateV, drainI, measDelay, igLimit, vdLimit, numNPLC)

  Description: This function uses the Model 2657A to force a current
  from drain to source. The SMU also measures the resulting voltage (Vds)
  with the FET channel turned off. A second System SourceMeter Instrument
  applies the gate to source voltage (Vgs) to ensure that the gate is
  turned off.

  Parameters:
    gateV: Applied gate voltage (Vgs).
    drainI: Test current applied by the Model 2657A from
    drain to source (Id).
    measDelay: Measurement delay before making the drain voltage
    measurement (Vgs).
    igLimit: Current limit (compliance) for the SMU connected to the
    FET gate terminal.
    vdLimit: Voltage limit (compliance) for the SMU connected to the
    FET drain terminal.
    numNPLC: Integration time for the drain voltage measurement
    (in number of power line cycles).

  Example usage:
  BVdss(0, 0.001, 0.01, 0.01, 2000, 1)
--]]

function BVdss(gateV, drainI, measDelay, igLimit, vdLimit, numNPLC)

  --Initialize SMU.
  reset()
  errorqueue.clear()
  status.reset()
  tsplink.reset()
```

```

--Configure source function.
node[2].smua.source.func = node[2].smua.OUTPUT_DCVOLTS
node[2].smua.source.levelv = gateV
node[2].smua.source.limiti = igLimit

smua.source.func = smua.OUTPUT_DCAMPS
smua.source.rangei = drainI
smua.source.leveli = drainI
smua.source.limitv = vdLimit

--Configure measurement parameters.
smua.measure.rangev = vdLimit
smua.measure.nplc = numNPLC
smua.measure.delay = measDelay

--Run the test.
node[2].smua.source.output = 1
smua.source.output = 1

I,V = smua.measure.iv()

smua.source.output = 0
node[2].smua.source.output = 0

print("Test current:", I)
print("Measured voltage:", V)

end

```

Example usage

The function in this script allows updates to the test parameters without rewriting or re-running the script. To run the test, call the `BVdss()` function, passing in the appropriate values for test parameters.

BVdss() parameters		
Parameter	Units	Description
gateV	volts	Gate voltage to apply with Series 2600A System SourceMeter Instrument
drainI	amps	Drain current forced by Model 2657A
measDelay	seconds	Measurement delay after applying drain current and before measuring BV_{dss}
igLimit	amps	Current limit for the Series 2600A SourceMeter Instrument connected to the MOSFET gate terminal
vdLimit	volts	Voltage limit (compliance) for the Model 2657A connected to the MOSFET drain terminal; should be greater than or equal to the expected BV_{dss} value
numNPLC	not applicable	Integration time, specified as the number of power line cycles

An example of how to call this function is shown here:

```
BVdss(0, 0.001, 0.01, 0.01, 2000, 1)
```

This call applies 0 V to the FET gate terminal and programs the Model 2657A to force 1 mA into the drain terminal. After 10 ms, the drain voltage is measured (up to 2000 V max). The measurement is made at 1 PLC. The actual drain current is also measured. The measurement results are automatically printed at the completion of the test. An example of the measurements results is:

```
Test current:      9.99856e-04
Measured voltage:  1.76940e+03
```

Idss measurement

This example:

- Performs the I_{dss} measurement, where the drain-to-source voltage (V_{ds}) is swept and leakage current measurements are made while the FET is in the off-state.
- Monitors the current measurement to see if the current limit has been reached. When the current limit has been reached, the voltage sweep is aborted.

With this method, a second System SourceMeter is used to apply a voltage from gate to source (V_{gs}). This example uses a TSP script to perform the measurement. The script includes two separate functions for configuring the System SourceMeter Instruments and returning current and voltage readings from the reading buffer.

Example code

```
--[[
  Title: FET Drain-to-Source Leakage Current Measurement Sweep

  Description: This script measures the drain current while the
  drain voltage is sweeping linearly and under a 0 V gate bias.
--]]

--[[
  Idss(gateV, startV, stopV, numSteps, measDelay, measRange, iLimit, numNPLC)

  Description: This function uses the Model 2657A to sweep the voltage
  across the drain up to the drain-source breakdown voltage and measure
  the drain current. A second SourceMeter instrument is used to bias the
  gate. For enhancement-mode power MOSFETs, a typical gate bias is 0 V.

  Parameters:
    gateV: Applied gate voltage bias (Vgs).
    startV: Starting drain voltage (Vds).
    stopV: Final drain voltage (Vds).
    numSteps: Number of points in the drain voltage sweep.
    measDelay: Measurement delay.
    measRange: Current measurement range for the drain current measurements.
    iLimit: Current limit (compliance) for the drain current.
    numNPLC: Integration time in the number of power line cycles.

  Example Usage:
  Idss(0, 10, 1760, 500, 0.05, 100e-9, 500e-6, 1)
--]]
```

```

function Idss(gateV, startV, stopV, numSteps, measDelay, measRange, iLimit, numNPLC)

--Initialize SMU.
reset()
errorqueue.clear()
status.reset()

--Configure reading buffers.
smua.nvbuffer1.clear()
smua.nvbuffer1.appendmode = 1
smua.nvbuffer1.collecttimestamps = 1

smua.nvbuffer2.clear()
smua.nvbuffer2.appendmode = 1
smua.nvbuffer2.collecttimestamps = 1

--Configure source parameters for the gate SMU.
node[2].smua.source.func = node[2].smua.OUTPUT_DCVOLTS
node[2].smua.source.levelv = gateV
node[2].smua.source.limiti = 0.001

--Configure source parameters for the drain SMU.
smua.source.func = smua.OUTPUT_DCVOLTS
smua.source.levelv = 0
smua.source.limiti = iLimit
if math.abs(startV) > math.abs(stopV) then
    smua.source.rangev = startV
else
    smua.source.rangev = stopV
end

--Configure measurement parameters for the drain SMU.
smua.measure.rangei = measRange
smua.measure.nplc = numNPLC
smua.measure.delay = measDelay

step = (stopV - startV)/(numSteps - 1)
voltage = startV
smua.source.levelv = voltage

--Run the test.
node[2].smua.source.output = 1
smua.source.output = 1
delay(1)

for i = 1, numSteps do
    smua.measure.iv(smua.nvbuffer1, smua.nvbuffer2);
    --Remove the following 4 lines if you do not want to monitor
    --for compliance
    testCmpl = smua.source.compliance
    if testCmpl == true then
        break
    end

    smua.source.levelv = voltage + step
    voltage = voltage + step
end
end

```

```

--Turn off the SMUs to complete the test.
smua.source.levelv = 0
node[2].smua.source.levelv = 0
node[2].smua.source.output = 0
smua.source.output = 0

printData()

end

function printData()

if smua.nvbuffer1.n == 0 then
print("No reading in buffer")
else
print("Timestamps\tVoltage\tCurrent")
for i = 1, smua.nvbuffer1.n do
print(string.format("%g\t%g\t%g", smua.nvbuffer1.timestamps[i],
smua.nvbuffer2.readings[i], smua.nvbuffer1.readings[i]))
end
end
end
end

```

Example usage

The functions in this script allow updates to the test parameters without rewriting or re-running the script. To run the test, call the `Idss()` function, passing in the appropriate values for test parameters.

Idss() parameters		
Parameter	Units	Description
gateV	volts	Gate voltage to apply with Series 2600A System SourceMeter Instrument
startV	volts	Start voltage for the drain voltage sweep
stopV	volts	Final voltage for the drain voltage sweep
numSteps	not applicable	Number of voltage steps to perform in the voltage sweep
measDelay	seconds	Measurement delay after applying drain voltage and before measuring drain leakage current
measRange	amps	Fixed current measurement range used to measure drain leakage current
iLimit	amps	Current limit (compliance) for the Model 2657A connected to the MOSFET drain terminal
numNPLC	not applicable	Integration time, specified as the number of power line cycles

An example of how to call this function is shown here:

```
Idss(0, 10, 1760, 500, 0.05, 100e-9, 500e-6, 1)
```

This call applies 0 V to the MOSFET gate terminal and programs the Model 2657A to generate a 500 point voltage sweep from 10 V to 1760 V at the drain terminal. After each voltage step, a 50 ms delay occurs before the current is measured. The measurement is made at 1 PLC. The measurements are stored in the instrument's reading buffers and are output from the communication interface immediately after the test is run.

Example output data is shown in the following graphic.

Figure 37: Example output data

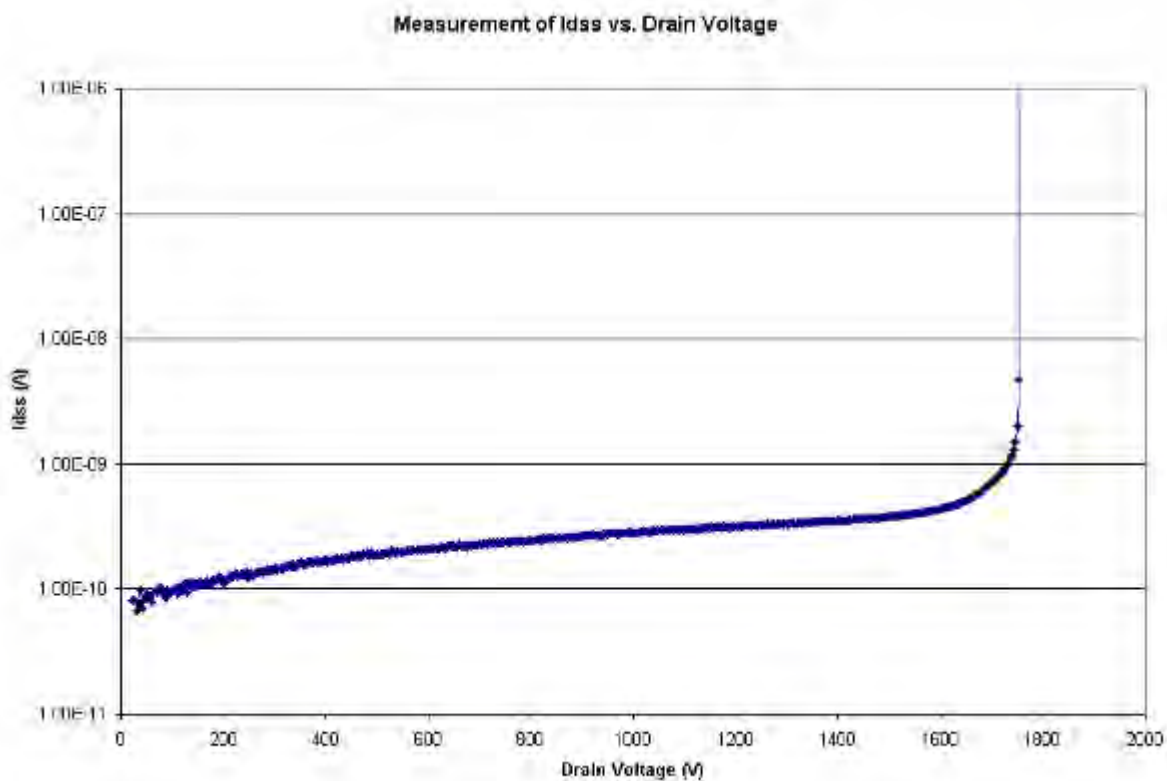

Measuring thyristor DC characteristics

In this section:

Introduction	9-1
Equipment required for this example.....	9-1
Set up communication.....	9-2
Device connections	9-3
V _{drm} and I _{drm} thyristor measurements	9-6
Determine the holding current of a thyristor	9-10
Determine the latching current of a thyristor	9-12

Introduction

These examples demonstrate how to use the Model 2657A High Power System SourceMeter[®] Instrument to characterize several DC characteristics of gated thyristors.

There are three examples in this section.

The first example performs measurements of peak forward off-state blocking voltage (V_{drm}) and its corresponding leakage current (I_{drm}). It can also be used to measure the peak reverse block voltage (V_{rrm}) and its corresponding leakage current (I_{rrm}).

The second example determines the holding current of the thyristor.

The third example determines the latching current of the thyristor.

Equipment required for this example

Equipment required:

- One Model 2657A High Power System SourceMeter[®] Instrument
- One Series 2600A System SourceMeter[®] Instrument (Model 2611A, Model 2612A, Model 2635A, or Model 2636A)
 - If needed, cables to connect the Series 2600A SourceMeter Instrument to the protection module
 - If needed, cables to connect the protection module to the test fixture
 - If a Model 2611A or Model 2612A is being used, one Model 2600-TRIAX adapter
- If you are not using a Model 8010 High Power Device Test Fixture, you need to use a Model 2657A-PM-200 Protection Module to ensure that the lower voltage Series 2600A SMU is protected if the device fails
- One GPIB or Ethernet cable to connect the Model 2657A to a computer
- One gated thyristor (for example, SCR or triac) enclosed in a safe test fixture
- Appropriate cabling to connect the SMUs to the test fixture, such as the Keithley Instruments Model 8010

Set up communication

The communication setup is illustrated in the following diagram. This application can be run using any of the supported communication interfaces for the instruments.

For additional detail about remote communications, see "Communications interfaces" in the Model 2657A Reference Manual.

Figure 38: Remote interface and TSP-Link communications setup

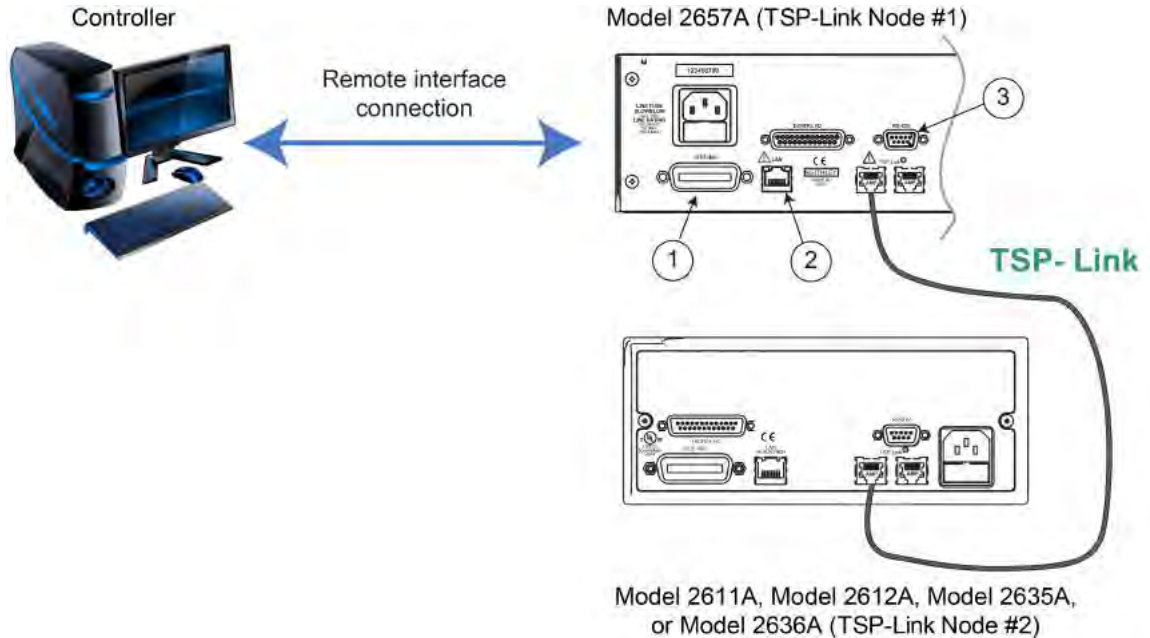

Item	Description	Qty	Notes
1	IEEE-488 connection	1	GPIB. Model 2657A is IEEE Std 488.1 compliant.
2	LAN connection	1	Model 2657A is LXI version 1.4 Core 2011 compliant. It supports TCP/IP and complies with IEEE Std 802.3 (ethernet). 10 or 100 Mbps. This is available from Keithley Instruments; see Model CA-180-3 LAN Crossover Cable.
3	RS-232 connection	1	Serial communication port.

NOTE

For the first example, no TSP-Link connections are required because only the Model 2657A at TSP-Link node 1 is used.

Device connections

Refer to the following figures to connect the thyristor in a safe test fixture.

See [Safe configuration and test setup](#) (on page 2-1) for information on safely connecting the Model 2657A to a device under test (DUT).

CAUTION

If a device under test fails, high voltage may be present at a terminal to which Series 2600A instruments are connected. This could damage a Series 2600A instrument. To prevent damage to the Series 2600A instrument, use a Model 2657A-PM-200 Protection Module. Failure to use a protection module could result in equipment damage.

Figure 39: Schematic for gated thyristor application example

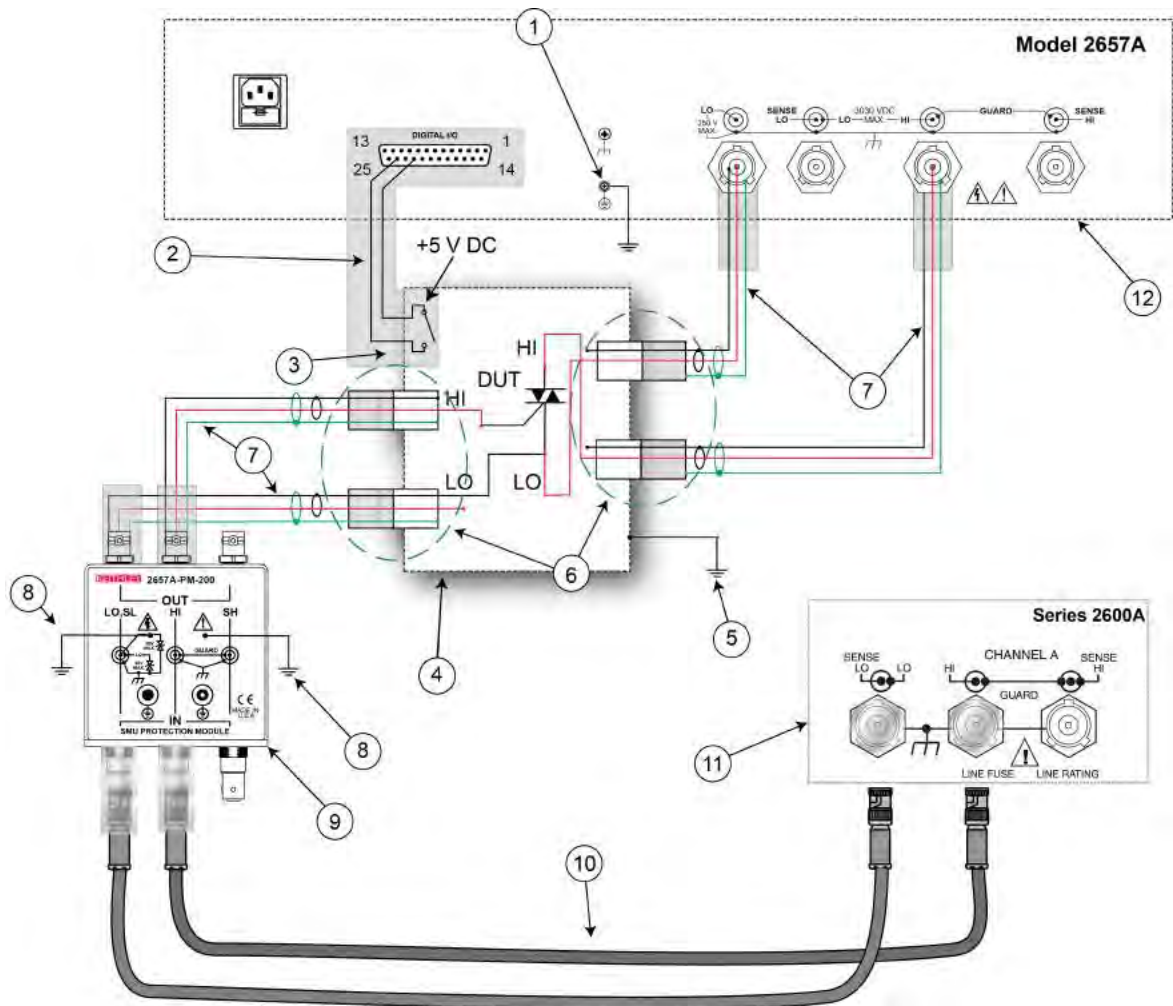

Item	Description	Qty	Notes
1	Model 2657A protective earth (safety ground)	1	Additional connections for redundant protective earth may be required. Keithley Instrument's Model CA-568 is a protective earth (safety ground) cable assembly.
2	Interlock connection	1	Model 2657A digital I/O; pin 24 (INT) and pin 22 (5 VDC) connected to the test fixture lid switch. Keithley Instrument's Model 7709-308 is a 25-pin interlock male connector that can be used for custom connections. Interlock switch is shown in the disengaged (lid open) position.
3	Test fixture interlock switch connection	1	
4	Interlocked metal safety enclosure	1	A safety enclosure with an interlock that has a normally-open (NO) switch.
5	Test fixture protective earth (safety ground)	1	Redundant grounds may be required for specific test setups.
6	Model HV-CA-571-3 High-Voltage Triaxial Panel-Mount Connector to Underminated Cable Assembly	4	See Using high-voltage triaxial connectors (on page 2-7).
7	Model HV-CA-554 High-Voltage Triaxial Cable	4	
8	Protective earth (safety ground) for the Model 2657A-PM-200	2	
9	Model 2657A-PM-200 Protection Module	1	Refer to documentation provided with Model 2657A-PM-200 for more information.
10	Model 7078-TRX Triaxial Cable Assembly	2	
11	Series 2600A System SourceMeter® Instrument	1	Model 2611A, Model 2612A, Model 2635A, or Model 2636A.
12	Model 2657A	1	

If you are using a Model 8010 High Power Test Fixture, see the Interconnect Reference Guide drawing "Three-terminal DUT with a Model 2657A". Also see the Model 8010 User's Manual for Model 2657A, Model 2611A, and Model 2612A connections.

Figure 40: Connections for gated thyristor application example

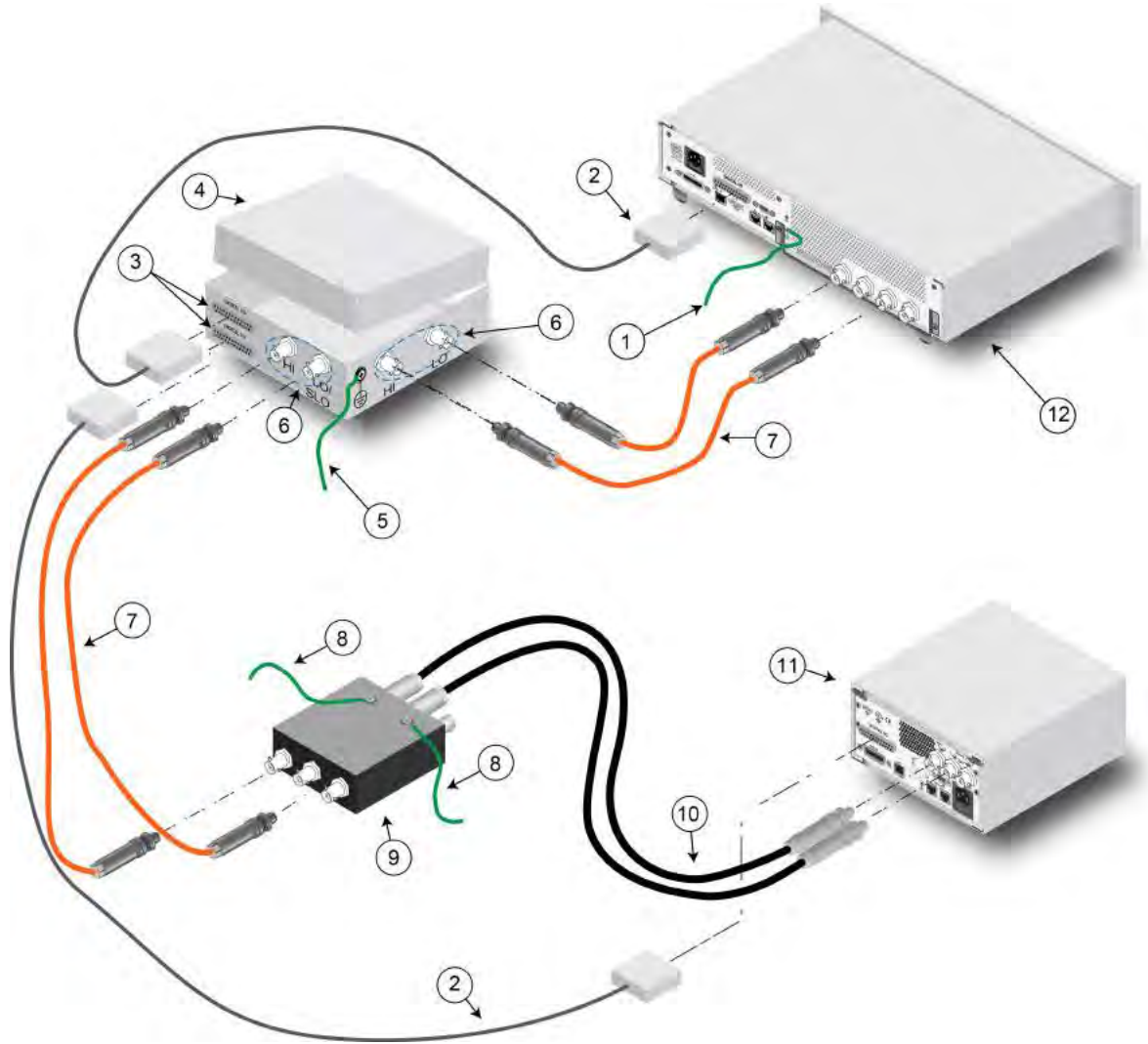

Vdrm and Idrm thyristor measurements

NOTE

The example code is designed to be run from Test Script Builder or TSB Embedded. It can also be run from other programming environments, such as Microsoft® Visual Studio® or National Instruments LabVIEW™. However, you may need to make changes to the example code to use other programming environments.

This example performs the V_{drm} and I_{drm} measurements, and may also be used to determine V_{rrm} and I_{rrm} . The Model 2657A is connected from anode to cathode and performs a voltage sweep while capturing current measurements at each point of the sweep.

This example uses a TSP script to perform the measurement. The script includes two separate functions for configuring the System SourceMeter Instrument and returning the raw current and voltage readings from the reading buffer.

The script is written using Test Script Processor (TSP) functions rather than as a single block of inline code. TSP functions are similar to functions in other programming languages, such as Microsoft® Visual C® or Visual Basic®. They must be called before the code in them is executed. Because of this, running the script alone will not execute the test. To execute the test, you need to run the script to load the functions into test script memory. You then call the functions.

Refer to the documentation for Test Script Builder or [TSB Embedded](#) (on page 4-4) for directions on how to run scripts and enter commands using the instrument console.

Example code

```
--[[
  offVoltLeakI(startV, stopV, numSteps, measDelay, measRange, iLimit, numNPLC)

  Description: This function can be used to determine Vdrm and Idrm or
  Vrrm and Irrm of a thyristor. In this function, the Model 2657A will
  perform a voltage sweep on the anode and measure the corresponding
  leakage current at each step. As no voltage or current bias is required
  on the gate terminal of the thyristor, this function can be used with
  gated and non-gated devices.

  To determine Vdrm and Idrm, connect the Model 2657A from anode to
  cathode of the device, and program positive start and stop voltages
  for the sweep.

  To determine Vrrm and Irrm, connect the Model 2657A from the anode to
  the cathode of the device, and program negative start and stop voltages
  for the sweep.
```

```

Parameters:
    startV: Starting drain voltage (Vds).
    stopV: Final drain voltage (Vds).
    numSteps: Number of points in the drain voltage sweep.
    measDelay: Measurement delay.
    measRange: Current measurement range for the drain current measurements.
    iLimit: Current limit (compliance) for the drain current.
    numNPLC: Integration time in number of power line cycles.

Example usage:

for Vdrm and Idrm:
offVoltLeakI(0, 800, 501, 0.010, 100e-6, 1e-3, 1)

for Vrrm and Irrm:
offVoltLeakI(0, -800, 501, 0.010, 100e-6, 1e-3, 1)
--]]

function offVoltLeakI(startV, stopV, numSteps, measDelay, measRange, iLimit, numNPLC)

--Initialize SMU.
reset()
errorqueue.clear()
status.reset()

--Configure reading buffers.
smua.nvbuffer1.clear()
smua.nvbuffer1.appendmode = 1
smua.nvbuffer1.collecttimestamps = 1

smua.nvbuffer2.clear()
smua.nvbuffer2.appendmode = 1
smua.nvbuffer2.collecttimestamps = 1

--Configure source parameters for the drain SMU.
smua.source.func = smua.OUTPUT_DCVOLTS
smua.source.levelv = 0
smua.source.limiti = iLimit
smua.source.rangev = stopV

--Configure measurement parameters for the drain SMU.
smua.measure.rangei = measRange
smua.measure.nplc = numNPLC
smua.measure.delay = measDelay
smua.measure.autozero = smua.AUTOZERO_ONCE

step = (stopV - startV)/(numSteps - 1)
voltage = startV

--Run the test.
smua.source.output = 1

for i = 1, numSteps do
    smua.measure.iv(smua.nvbuffer1, smua.nvbuffer2)
    smua.source.levelv = voltage + step
    voltage = voltage + step
end

```

```

--Run the test.
smua.source.levelv = 0
smua.source.output = 0

printData()

end

function printData()

if smua.nvbuffer1.n == 0 then
print("No reading in buffer")
else
print("Timestamps\tVoltage\tCurrent")
for i = 1, smua.nvbuffer1.n do
print(string.format("%g\t%g\t%g", smua.nvbuffer1.timestamps[i],
smua.nvbuffer2.readings[i], smua.nvbuffer1.readings[i]))
end
end
end
end

```

Example usage

The function in this script allows updates to the test parameters without rewriting or re-running the script. To run the test, call the `offVoltLeakI()` function, passing in the appropriate values for test parameters.

offVoltLeakI() parameters		
Parameter	Units	Description
startV	volts	Start value for the voltage sweep performed at the anode
stopV	volts	Stop value for the voltage sweep performed at the anode
numSteps	not applicable	Number of steps in the voltage sweep
measDelay	seconds	Measurement delay prior to making a measurement (allows for source and system settling)
measRange	amps	Current range on which to perform the leakage current measurements
iLimit	amps	Current limit (compliance) for the Model 2657A
numNPLC	not applicable	Integration time, specified as the number of power line cycles

An example of how to call this function is shown here:

```

--for Vdrm and Idm:
offVoltLeakI(0, 800, 501, 0.01, 100e-6, 1e-3, 1)

```

This function call programs the Model 2657A to sweep from 0 V to +800 V in 501 steps. After each source step, a 10 ms delay occurs and then the Model 2657A makes a 1 NPLC current measurement on the 100 μ A range. The current limit is set to 1 mA. All current and voltage measurements are automatically printed to the communication interface at the conclusion of the test.

The data that results is shown in the following graphic.

Figure 41: Thyristor measurement sample output

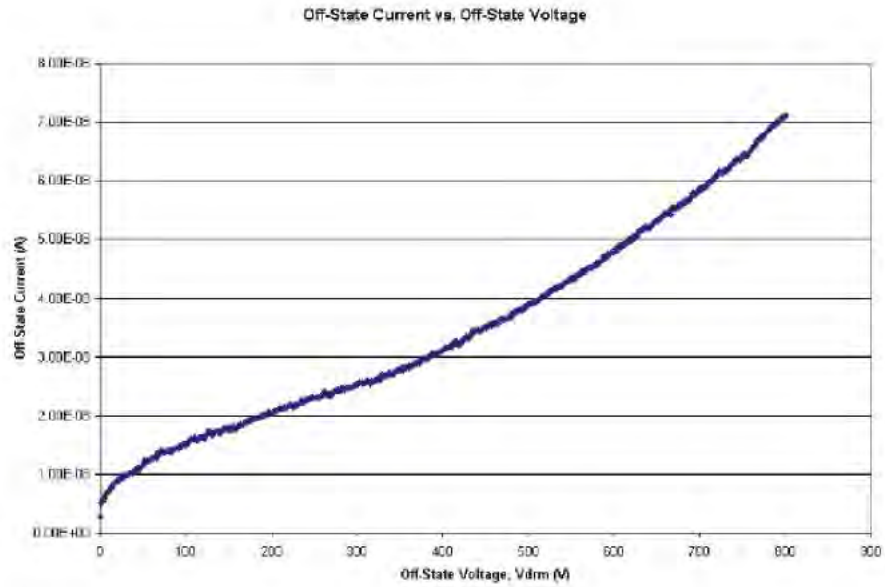

Another example of how to call this function is shown here:

```
--for Vrrm and Irrm:  
offVoltLeakI(0, -800, 501, 0.010, 100e-6, 1e-3, 1)
```

This function call programs the Model 2657A to sweep from 0 V to -800 V in 501 steps. After each source step, a 10 ms delay occurs and then the Model 2657A makes a 1 NPLC current measurement on the 100 μ A range. The current limit is set to 1 mA. All current and voltage measurements are automatically printed to the communication interface at the conclusion of the test.

An example of the output of this test is shown in the graphic below.

Figure 42: Sample output Vrrm

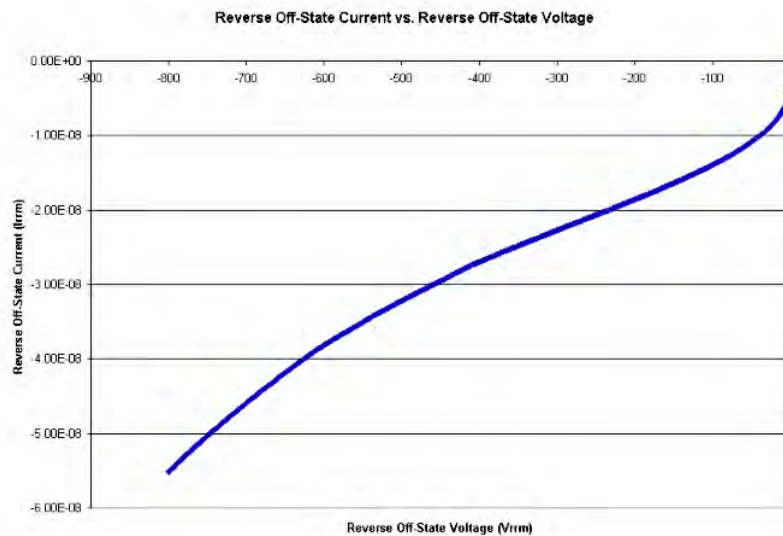

Determine the holding current of a thyristor

This example determines the holding current of a thyristor. The holding current is the minimum DC current at which the thyristor turns off after the gate signal is removed.

Two SourceMeter instruments are required for this example. One SourceMeter instrument triggers the thyristor to turn on by supplying a current to the thyristor's gate terminal. Once triggered, the gate signal is removed. The Model 2657A applies a voltage bias to the thyristor's anode with an initial current limit greater than or equal to the specified latching current of the thyristor. This ensures that it stays in the on-state after the gate signal is removed. The current limit is gradually decreased until the device turns off. This final current is the holding current.

Example code

```
--[[
    holdingCurr(gateBiasCurr, gateVoltLimit, gateOnTime, anodeBiasVolt,
               anodeLatchingCurr, anodeCurrStep, numNPLC)

Description: This function can be used to determine Ih of a thyristor.
Two SMUs are required for this function. One SMU (node[2].smua) is
connected to the gate terminal and is used to trigger the device.
The Model 2657A (smua) is connected to the anode and is applying
a voltage bias.
After the device is turned on, the gate signal is removed and the
current limit of the Model 2657A is varied until the device turns off.
The current at which the device turns off is the holding current.

Parameters:
    gateBiasCurr = Current to apply to the gate to trigger the device on.
                  Should be greater than or equal to the gate trigger current.
    gateVoltLimit = Voltage limit for the gate SMU. Should be greater
                  than or equal to the gate trigger voltage.
    gateOnTime = Number of seconds to apply the gate trigger
                (single pulse event).
    anodeBiasVolt = Model 2657A applies this voltage to the anode terminal.
    anodeLatchingCurr = Specified latching current of the device.
    anodeCurrStep = How much to vary the anode current in order to
                  arrive at the holding current.
    numNPLC = Integration time in number of power line cycles.

Example usage:

    holdingCurr(0.05, 10e-3, 2, 12, 0.06, 0.005, 1)
--]]

function holdingCurr(gateBiasCurr, gateOnTime, gateVoltLimit, anodeBiasVolt,
                    anodeLatchingCurr, anodeCurrStep, numNPLC)

    --Initialize instruments and clear errors and status registers.
    tsplink.reset()
    reset()
    errorqueue.clear()
    status.reset()
```

```

--Configure gate SMU.
node[2].smua.source.func = node[2].smua.OUTPUT_DCAMPS
node[2].smua.source.rangei = gateBiasCurr
node[2].smua.source.leveli = gateBiasCurr
node[2].smua.source.limitv = gateVoltLimit
node[2].smua.source.delay = 0

--Configure anode SMU source parameters.
smua.source.func = smua.OUTPUT_DCVOLTS
smua.sense = smua.SENSE_LOCAL
smua.source.rangev = anodeBiasVolt
smua.source.levelv = anodeBiasVolt
smua.source.limitsi = anodeLatchingCurr
--[[
    This is the initial current limit to ensure that the device stays
    on after the gate.
--]]

--Configure anode SMU measure parameters.
smua.measure.rangei = anodeLatchingCurr
smua.measure.nplc = numNPLC
smua.measure.autozero = smua.AUTOZERO_ONCE

numSteps = ((anodeLatchingCurr - 0) / (anodeCurrStep)) + 1

if anodeCurrStep >= anodeLatchingCurr then
    print("Wrong value: The current step cannot be greater than or equal to the
    expected latching current.")
else
    smua.source.output = 1
    node[2].smua.source.output = 1
    delay(gateOnTime)
    node[2].smua.source.output = 0

    for i = 1, numSteps do
        smua.measure.i()
        cmlCheck = smua.source.compliance
        if cmlCheck == false then
            break
        else
            smua.source.limitsi = anodeLatchingCurr - (i*anodeCurrStep)
        end
    end

    --Complete the test and output the result.
    smua.source.output = 0
    finalIh = smua.source.limitsi
    print("Holding Current (Amps): ", finalIh)
end
end

```

Example usage

The functions in this script allow updates to the test parameters without rewriting or re-running the script. To run the test, call the `holdingCurr()` function, passing in the appropriate values for test parameters.

holdingCurr() parameters		
Parameter	Units	Description
gateBiasCurr	amps	Gate current to apply with the Series 2600A SourceMeter instrument.
gateVoltLimit	volts	Voltage limit (compliance) for the Series 2600A connected to the thyristor's gate terminal.
gateOnTime	seconds	Amount of time to apply the gate signal.
anodeBiasVolt	volts	Anode voltage provided by the Model 2657A.
anodeLatchingCurr	amps	Specified latching current of the thyristor. This is also the initial current limit (compliance) of the Model 2657A connected to the anode terminal. The latching current is typically more than or equal to the holding current. Ensure that this value is larger than holding current for this test.
anodeCurrStep	amps	The step size of the change in anode current.
numNPLC	not applicable	Integration time, specified as number of power line cycles.

An example of how to call this function is shown here:

```
holdingCurr(0.05, 10e-3, 2, 12, 0.06, 0.005, 1)
```

This function call uses the Series 2600A SourceMeter Instrument to apply 50 mA for 2 s to trigger the thyristor to turn on. Meanwhile, the Model 2657A applies 12 V to the anode with an initial current limit of 60 mA. Since the device is in the on-state, the Model 2657A should be in current limit. The current limit is decreased in 5 mA increments. The program monitors the current limit bit of the status register in order to determine when the Model 2657A returns to normal voltage sourcing conditions, which indicates that the device has turned off. This final programmed current limit is the holding current.

The result of the function call for this example is:

```
Holding Current (Amps): 2.40000e-02
```

Determine the latching current of a thyristor

This example determines the latching current of a thyristor. The latching current is the minimum DC anode current at which the device remains in the on-state after the gate signal is removed.

Two SourceMeter instruments are required for this example. The Series 2600A SourceMeter Instrument provides a repetitive square-wave like signal to the gate to trigger and re-trigger the device. The Model 2657A supplies current to the thyristor's anode. Each time the gate is removed, the program checks the Model 2657A voltage limit to determine if the device is on. If the device has not stayed on, the anode current is increased and the device is re-triggered. This process continues until the thyristor remains on even after the gate signal is removed. The first anode current at which this occurs is the latching current.

Example code

```
--[[
latchingCurr(gateBiasCurr, gateVoltLimit, gateOnTime, anodeStartCurr,
anodeMaxCurr, anodeStepCurr, anodeVoltLimit, numNPLC)

Description: This function can be used to determine latch of a
thyristor. Two SMUs are required for this function. One SMU
(node[2].smua) is connected to the gate terminal and is used to
trigger the device. The Model 2657A (smua) is connected to the anode
and is used to source the current.
The gate is triggered while a current bias is applied to the anode.
The gate current is removed and measurements are made to verify that the
device is on. If the device is off, the current at the anode is
increased and the gate is re-triggered. This continues until the
device remains on even after the gate signal is removed.
The current at which the device remains on is the latching current.

In order to complete this task, custom list sweeps are configured on
the gate and anode SMUs.

Parameters:
gateBiasCurr = Current to apply to the gate to trigger the device on.
Should be greater than or equal to the gate trigger current.
gateVoltLimit = Voltage limit for the gate SMU. Should be greater
than or equal to the gate trigger voltage.
gateOnTime = Number of seconds to apply the gate trigger
(single pulse event).
anodeStartCurr = Start value for the anode current sweep.
Typically slightly less than or equal to the holding current value.
anodeMaxCurr = Stop value for the anode current sweep. May not reach
this value, but this is the maximum value to source.
anodeStepCurr = Step value for the anode current sweep.
anodeVoltLimit = Voltage limit for the anode SMU. Should be equal
to Vdrm.
numNPLC = Integration time in number of power line cycles.

Example usage:

latchingCurr(0.060, 10, 1e-3, 0.020, 0.120, 0.005, 600, 0.01)
--]]

function latchingCurr(gateBiasCurr, gateVoltLimit, gateOnTime, anodeStartCurr,
anodeMaxCurr, anodeStepCurr, anodeVoltLimit, numNPLC)

--Initialize instruments and clear errors and status registers.
tsplink.reset()
reset()
errorqueue.clear()
status.reset()
```

```

--Configure gate SMU.
node[2].smua.source.func = node[2].smua.OUTPUT_DCAMPS
node[2].smua.source.rangei = gateBiasCurr
node[2].smua.source.leveli = 0
node[2].smua.source.limitv = gateVoltLimit
node[2].smua.source.delay = gateOnTime

--Configure anode SMU source parameters.
smua.source.func = smua.OUTPUT_DCAMPS
smua.sense = smua.SENSE_LOCAL
smua.source.rangei = anodeMaxCurr
smua.source.leveli = 0
smua.source.limitv = anodeVoltLimit

--Configure anode SMU measurement parameters.
smua.measure.delay = 0.005
--Must have delay if you want reasonable anode measurements.

smua.measure.rangev = anodeVoltLimit
smua.measure.nplc = numNPLC
smua.measure.autozero = smua.AUTOZERO_ONCE

smua.nvbuffer1.clear()
smua.nvbuffer2.clear()
smua.nvbuffer1.appendmode = 1
smua.nvbuffer2.appendmode = 1
smua.nvbuffer1.collecttimestamps = 1
smua.nvbuffer2.collecttimestamps = 1

--Create custom sweeps for anode and gate SMUs.
numSwpPts = 2*((anodeMaxCurr - anodeStartCurr)/(anodeStepCurr)) + 1

gateSwp = {}
anodeSwp = {}

for i = 1, numSwpPts do
    if math.mod(i,2) == 0 then
        gateSwp[i] = 0
    else
        gateSwp[i] = gateBiasCurr
    end
end

for j = 1, numSwpPts, 2 do
    anodeSwp [j] = anodeStartCurr + ((j-1)/2)*anodeStepCurr
    anodeSwp[j+1] = anodeStartCurr + ((j-1)/2)*anodeStepCurr
end

```

```

smua.source.output = 1
node[2].smua.source.output = 1

for k = 1, numSwpPts, 2 do
    smua.source.level1 = anodeSwp[k]
    node[2].smua.source.level1 = gateSwp[k]
    node[2].smua.source.level1 = gateSwp[k+1]
    smua.measure.iv(smua.nvbuffer1,smua.nvbuffer2)
    checkCmpl = smua.source.compliance
--[[
    If in compliance, then device is off. If out of compliance, then
    device is on and we have reached latching current.
--]]

    if checkCmpl == false then
        finalIL = anodeSwp[k]
        break
    end
end

node[2].smua.source.output = 0
smua.source.output = 0
print("Latching current(amps): ", finalIL)
print("Raw data follows:")
printData()
end

```

Example usage

The function in this script allows updates to the test parameters without rewriting or re-running the script. To run the test, call the `latchingCurr()` function, passing in the appropriate values for test parameters.

latchingCurr() parameters		
Parameter	Units	Description
gateBiasCurr	amps	Gate current to apply with the Series 2600A SourceMeter instrument.
gateVoltLimit	volts	Voltage limit (compliance) for the Series 2600A connected to the gate terminal of the thyristor.
gateOnTime	seconds	Amount of time to apply the gate signal.
anodeStartCurr	amps	Initial anode current provided by the Model 2657A. Should be much less than the specified latching current.
anodeMaxCurr	amps	Maximum anode current to apply with the Model 2657A.
anodeStepCurr	amps	Step size of the current sweep occurring at the anode of the thyristor.
anodeVoltLimit	volts	Voltage limit (compliance) of the Model 2657A.
numNPLC	not applicable	Integration time, specified as the number of power line cycles.

An example of how to call this function is shown here:

```
latchingCurr(0.060, 10, 1e-3, 0.020, 0.120, 0.005, 600, 0.01)
```

This call uses the Series 2600A SourceMeter instrument to apply 60 mA for 1 ms to trigger the thyristor to turn on. Meanwhile, the Model 2657A applies 20 mA to the anode terminal. The gate signal is removed by programming the Model 2600A to force zero amps.

The program monitors the voltage limit on the Model 2657A. If the voltage limit is indicated, the device is off. The Model 2657A then increases the supplied anode current and the device is re-triggered. This process is repeated until the thyristor remains on. This final programmed current limit is the latching current.

The result of the function call for this example is:

```
Latching Current (Amps): 2.90000e-02
```

Troubleshooting FAQs

In this section:

About this section.....	10-1
How do I change the line frequency or voltage?	10-1
Where can I find updated drivers?	10-2
Can I convert to coaxial cables?	10-2
How do I connect LO terminals of multiple SMUs together? ..	10-2
What should I do if I get an 802 interlock error?.....	10-3
Why is the reading value 9.91e37?	10-3
Why is the reading value 9.92e37?	10-3

About this section

The purpose of this section is to help you troubleshoot the most common problems encountered with the Model 2657A. For additional troubleshooting information, please see the "Troubleshooting" section in the Model 2657A Reference Manual.

How do I change the line frequency or voltage?

I need to use a Model 2657A at a different power line frequency or voltage. What do I need to do?

The Model 2657A requires a line voltage of 100 V AC to 240 V AC ($\pm 10\%$), and a line frequency of 50 Hz or 60 Hz. Keithley Instruments sets the line frequency of the Model 2657A for the final shipping destination of the instrument.

You can manually configure the instrument to match the actual line frequency.

To configure the line frequency from the front panel:

1. Press the **MENU** key.
2. Turn the navigation wheel to select **LINE-FREQ.**
3. Press the **ENTER** key.
4. Turn the navigation wheel to select the appropriate frequency.
5. Press the **ENTER** key.
6. Press the **EXIT (LOCAL)** key to return to the default display screen.

Where can I find updated drivers?

For the latest drivers and additional support information, see the Keithley Instruments support website.

To see what drivers are available for your instrument:

1. Go to the [Keithley Instruments support website](http://www.keithley.com/support) (<http://www.keithley.com/support>).
2. Enter the model number of your instrument.
3. Select Software Driver from the list.

For LabVIEW, you can also go to National Instrument's website and search their instrument driver database.

Can I convert to coaxial cables?

Use the optional cable assembly (Keithley Instruments part number SHV-CA-553), which converts a high-voltage triaxial connector to a safe high-voltage (SHV) connector. See [Using coaxial connections \(SHV\)](#) (on page 2-4) for detail.

How do I connect LO terminals of multiple SMUs together?

To connect the SENSE LO and LO terminals of the Model 2657A to other source-measure units (SMUs), use the Model 2657A-LIM-3 LO Interconnect Module. For more details, refer to the Model 2657A-LIM-3 LO Interconnect Module documentation (PA-1063).

NOTE

If you are connecting to a lower-voltage SMU, you must first connect the lower-voltage SMU to a Keithley Instruments Model 2657A-PM-200 Protection Module using triaxial connections only. Compatible lower-voltage SMUs include the Models 2611A, 2612A, 2635A, 2636A, 4200-SCS, 4200-SMU, and 4210-SMU. For more information about the Model 2657A-PM-200 protection module, refer to the Model 2657A-PM-200 Protection Module documentation (PA-1055).



WARNING

The Model 2657A High Power System SourceMeter® Instrument and its associated cabling are designed to be safe when operated correctly in a 3000 V system. They are only warranted to the maximum voltage and current ratings of the instrument. Connecting two Model 2657A instruments in parallel or in series may result in voltages or power levels that exceed the safety mechanisms. This increases the risk of instrument damage and the possibility of personal injury or death due to electric shock. The user assumes all of the associated risks of combining the outputs of two or more Model 2657A instruments.

What should I do if I get an 802 interlock error?

You will receive error code 802, "OUTPUT blocked by interlock," if you:

- Disengage the interlock when the Model 2657A output is already on
- Attempt to turn on the Model 2657A output when the interlock is disengaged

To recover from this error, properly engage the interlock using a safe test fixture, and then turn on the Model 2657A output.

Why is the reading value 9.91e37?

This value indicates that there is a measurement overflow error. This error occurs when:

- A measurement performed on a fixed range has a measured value greater than the specified range
- The measured value is larger than the maximum current or voltage range of the instrument (exceeds the instrument rating)

If the instrument displays the overflow message on a particular range, select a higher range until an on-range reading is displayed. To ensure the best accuracy and resolution, use the lowest range possible that does not cause an overflow.

Why is the reading value 9.92e37?

This value indicates an overvoltage condition. This can occur if:

- The overvoltage protection (OVP) limit value is exceeded
- There are incorrect connections to the device under test (DUT)
- Remote sense is enabled and the sense HI and sense LO are improperly or incorrectly connected to the DUT

The OVP limit can be set from the Model 2657A front panel or through a remote interface.

To set the OVP limit from the instrument front panel:

1. Press the **CONFIG** key, and then select **SRC > V-SOURCE > PROTECTION**.
2. Enter the desired OVP value.
3. Press **Enter**.

To set the OVP limit through a remote interface, use the `smuX.source.protectv` attribute (see the "Command reference" section in the Model 2657A Reference Manual for details about this command).

For more information about overvoltage protection, see "Overvoltage protection (OVP)" in the Model 2657A Reference Manual.

In this section:

[Additional Model 2657A information.....](#) 11-1

Additional Model 2657A information

For additional information about the Model 2657A, refer to:

- The Product Information CD-ROM (which ships with the product). Contains software tools, drivers, and product documentation
- The [Keithley Instruments website \(http://www.keithley.com\)](http://www.keithley.com): Contains the most up-to-date product information; from the website, you can access:
 - The Knowledge Center, where you can order the following handbooks:
 - *The Low Level Measurements Handbook: Precision DC Current, Voltage, and Resistance Measurements*
 - *Switching Handbook: A Guide to Signal Switching in Automated Test Systems*
 - Application notes
 - Updated drivers
 - Information on related products, including:
 - The Model 4200-SCS Semiconductor Characterization System
 - The Series 2600A System SourceMeter® instruments
 - The Model 2651A High Power System SourceMeter instrument
 - The Model 8010 High Power Device Test Fixture
- Your local Field Applications Engineer can help you with product selection, configuration, and usage. Check the website for contact information.

A

- abort script • 4-7
- applications
 - basic front panel measurements • 5-1
 - measure diode characteristics • 6-1
 - measure leakage current and insulation resistance of capacitors • 7-1
 - measure thyristor DC characteristics • 9-1
 - MOSFET characterization • 8-1
 - thyristor DC characteristics • 9-1

C

- coaxial connections • 2-4
- compliance limits
 - set through front panel • 5-4
- connection
 - device • 5-2
 - diode application • 6-3
 - front-panel measurement • 5-2
 - MOSFET application • 8-3
 - thyristor application • 9-3
 - web interface • 4-1

D

- delete script • 4-7
- Discovery Tool, LXI • 4-1
- display
 - observing readings • 4-7, 5-5
- download
 - reading buffer • 4-7

E

- error messages
 - interlock • 10-3
- example applications
 - basic front panel measurements • 5-1
 - measure diode characteristics • 6-1
 - measure leakage current and insulation resistance of capacitors • 7-1
 - measure thyristor DC characteristics • 9-1
 - MOSFET characterization • 8-1
- exercises
 - create and run script with TSB Embedded • 4-4
 - retrieve readings from buffer • 4-7
- export script • 4-7

F

- FAQs • 10-1
- front panel • 3-2
 - compliance limit • 5-4
 - indicators • 3-2
 - interface • 3-1
 - measurements • 5-1, 5-4
 - output, on/off • 5-4
 - readings • 5-5
 - source-measure procedure • 5-4
 - using • 3-1
- functions
 - selecting • 5-4

H

- HV triaxial connections • 2-7

I

- import script • 4-7
- indicators • 3-2
- interlock • 2-3
 - error • 10-3
- IP address • 4-3

J

- Java plug-in • 4-1

K

- keypad • 3-4
- keys • 3-2, 3-3

L

- LXI Discovery Tool • 4-1
 - download • 4-1

M

- measurement
 - front panel • 5-1, 5-4
 - function, selecting • 5-4
 - ranges • 5-4
 - thyristor DC characteristics • 9-1

N

- navigation wheel • 3-2, 3-4

number keys • 3-3

O

operation keys • 3-3

output enable • 5-4

OUTPUT ON/OFF control • 3-2, 5-4, 5-5

R

range

selecting autorange • 5-4

reading buffer • 4-7

displaying readings • 4-7

downloading • 4-7

readings

display • 5-5

observing • 4-7, 5-5

S

scripts

abort • 4-7

clearing • 4-7

create in TSB Embedded • 4-4

deleting • 4-7

exporting • 4-7

importing • 4-7

management • 4-7

stopping • 4-7

viewing • 4-7

SHV coaxial • 2-4

source

level • 5-4

T

triaxial connections • 2-7

troubleshooting • 10-1

FAQs • 10-1

IP address • 4-1, 4-3

line frequency • 10-1

voltage • 10-1

web page • 4-1, 4-2

TSB Embedded • 4-4

script, create with • 4-4

TSP Express • 4-9

V

voltage

source, set level • 5-4

W

Warranty • 1-1

web interface • 4-1

accessing • 4-1

browser requirements • 4-1

Home page • 4-2

IP address configuration • 4-3

reading buffers • 4-7

TSB Embedded • 4-4

TSP Express • 4-9

using • 4-1



北京海洋兴业科技股份有限公司 (证券代码: 839145)

北京市西三旗东黄平路19号龙旗广场4号楼 (E座) 906室

电话: 010-62176775 62178811 62176785

企业QQ: 800057747 维修QQ: 508005118

企业官网: www.hyxyyq.com

邮编: 100096

传真: 010-62176619

邮箱: market@oitek.com.cm

购线网: www.gooxian.net



扫描二维码关注我们

查找微信公众号: 海洋仪器