

R&S®NGC100

Power Supply Series

User Manual



致力于电子测试、维护领域!



1179168702
Version 01

ROHDE & SCHWARZ
Make ideas real



北京海洋兴业科技股份有限公司 (股票代码: 839145) | 电话: 010-62178811 传真: 010-62176619 | 网址: www.hyxyyq.com

This manual describes the instruments of the R&S®NGC power supply series and its options:

- R&S®101 Single-channel power supply 100W (3657.2288.02)
- R&S®101-G Single-channel power supply 100W GPIB (3657.2288.03)
- R&S®102 Two-channel power supply 100W (3657.2359.02)
- R&S®102-G Two-channel power supply 100W GPIB (3657.2359.03)
- R&S®103 Three-channel power supply 100W (3657.2413.02)
- R&S®103-G Three-channel power supply 100W GPIB (3657.2413.03)

© 2023 Rohde & Schwarz

Muehldorfstr. 15, 81671 Muenchen, Germany

Phone: +49 89 41 29 - 0

Email: info@rohde-schwarz.com

Internet: www.rohde-schwarz.com

Subject to change – data without tolerance limits is not binding.

R&S® is a registered trademark of Rohde & Schwarz GmbH & Co. KG.

Trade names are trademarks of the owners.

1179.1687.02 | Version 01 | R&S®NGC100

Throughout this manual, products from Rohde & Schwarz are indicated without the ® symbol , e.g. R&S®NGC100 is indicated as R&S NGC100.

Contents

1	Safety and regulatory information.....	9
1.1	Safety instructions.....	9
1.2	Labels on R&S NGC100.....	12
1.3	Warning messages in the documentation.....	13
1.4	Korea certification class A.....	14
2	Welcome to R&S NGC100.....	15
2.1	Documentation overview.....	15
2.1.1	Manuals.....	15
2.1.2	Data sheet.....	16
2.1.3	Calibration certificate.....	16
2.1.4	Release notes, open source acknowledgment (OSA).....	16
2.1.5	Application notes, application cards, white paper, etc.....	17
2.1.6	Remote control driver.....	17
2.2	Conventions used in the documentation.....	17
2.2.1	Typographical conventions.....	17
2.2.2	Notes on screenshots.....	17
3	Getting started.....	18
3.1	Preparing for use.....	18
3.1.1	Lifting and carrying.....	18
3.1.2	Unpacking and checking.....	18
3.1.3	Choosing the operating site.....	18
3.1.4	Setting up the R&S NGC100.....	19
3.1.5	Considerations for test setup.....	21
3.1.6	Connecting to power.....	22
3.1.7	Switching on or off.....	24
3.1.8	Connecting to LAN.....	25
3.1.9	Connecting USB devices.....	26
3.2	Instrument tour.....	26
3.2.1	Front panels.....	26
3.2.2	Rear panel.....	30
3.3	Trying out the instrument.....	32

3.3.1	Selecting the channels.....	32
3.3.2	Setting the output voltage and current limits.....	33
3.3.3	Activating the channel output.....	34
3.3.4	Storing/Recalling of instrument settings.....	34
3.4	Instrument control.....	35
3.4.1	Ways to operate the instrument.....	35
3.4.2	Means of manual interaction.....	35
3.4.3	Remote control.....	44
4	Operating basics.....	46
4.1	Front panel keys.....	46
4.1.1	Function keys.....	46
4.1.2	Navigation controls.....	50
4.2	Power derating.....	51
4.3	Operation modes.....	52
5	Instrument functions.....	53
5.1	Voltage and current.....	53
5.2	Channel output.....	55
5.3	Electronic fuse.....	57
5.3.1	Activating fuse.....	57
5.3.2	Fuse delay, fuse linking.....	58
5.4	Tracking function.....	60
5.5	Protection.....	62
5.6	Analog input.....	65
5.7	Sequencing.....	68
5.8	External trigger.....	71
5.9	Measurement functions.....	71
5.9.1	Statistics.....	71
5.9.2	Energy meter.....	73
5.9.3	Data logging.....	75
5.10	Advanced functions.....	82
5.10.1	EasyArb.....	82
5.10.2	EasyRamp.....	92

6	File and data management.....	94
6.1	Save and recall.....	94
6.2	Screenshot.....	97
7	General instrument functions.....	100
7.1	Update (firmware).....	100
7.2	Remote control interface.....	101
7.3	Miscellaneous.....	102
7.3.1	Device information.....	103
7.3.2	Date time.....	104
7.3.3	Sound.....	105
7.3.4	Display settings.....	106
7.3.5	Key brightness.....	107
7.3.6	Device name.....	108
7.3.7	CSV.....	108
7.3.8	Power up.....	110
7.4	Default settings.....	111
8	Network operation and remote control.....	112
8.1	Remote control interfaces and protocols.....	112
8.1.1	LAN interface.....	114
8.1.2	USB interface.....	118
8.1.3	GPIB interface (IEC/IEEE bus interface).....	120
8.1.4	LXI browser interface.....	121
8.1.5	SCPI.....	123
8.1.6	VISA.....	123
8.2	Setting up remote control connection.....	124
8.2.1	LAN connection.....	124
8.2.2	USB connection.....	126
8.2.3	GPIB connection.....	126
8.3	Starting and stopping remote control.....	127
8.4	Status reporting system.....	128
8.4.1	Structure of a SCPI status register.....	128
8.4.2	Contents of the status registers.....	130
8.4.3	Error queue.....	132

9	Remote control commands.....	133
9.1	Common setting commands.....	133
9.2	System commands.....	136
9.3	Display commands.....	138
9.4	Trigger commands.....	139
9.5	Configuration commands.....	139
9.5.1	Channel selecting.....	139
9.5.2	Voltage setting.....	141
9.5.3	Current setting.....	143
9.5.4	Combined voltage and current settings.....	146
9.5.5	Output setting.....	146
9.5.6	Fuse setting.....	148
9.5.7	OVP setting.....	152
9.5.8	OPP setting.....	155
9.6	Measurement commands.....	158
9.7	Advanced operating commands.....	159
9.7.1	Arbitrary commands.....	159
9.7.2	EasyRamp commands.....	164
9.7.3	Analog In.....	165
9.7.4	Sequencing.....	167
9.8	Data and file management commands.....	169
9.9	Status reporting commands.....	176
9.9.1	STATus:OPERation registers.....	176
9.9.2	STATus:QUESTionable registers.....	177
10	Troubleshooting.....	180
10.1	Displaying status information.....	180
10.2	Problems during firmware update.....	180
10.3	Problems with remote control over LAN.....	181
10.3.1	Cannot establish a LAN connection.....	181
10.3.2	Cannot communicate over LAN.....	181
10.4	Contacting customer support.....	181
11	Transport.....	183

12	Maintenance, storage and disposal.....	184
12.1	Cleaning.....	184
12.2	Changing fuses.....	184
12.3	Internal battery replacement.....	184
12.4	Storage.....	185
12.5	Disposal.....	185
13	Applications.....	186
13.1	Series mode.....	186
13.2	Parallel mode.....	187
	Annex.....	188
A	Additional basics on remote control.....	188
A.1	Messages and SCPI command structure.....	188
A.1.1	Messages.....	188
A.1.2	SCPI command structure.....	189
A.1.3	SCPI parameters.....	191
A.1.4	Overview of syntax elements.....	193
A.1.5	Responses to queries.....	194
A.2	Command sequence and synchronization.....	194
A.2.1	Preventing overlapping execution.....	195
A.2.2	Using several threads in the controller application.....	196
	List of commands.....	197
	Index.....	200

1 Safety and regulatory information

The product documentation helps you use the product safely and efficiently. Follow the instructions provided here and in the following chapters.

Intended use

The product is intended for the development, production and verification of electronic components and devices in industrial, administrative, and laboratory environments by personnel familiar with the potential risks of measuring electrical quantities.

Use the product only for its designated purpose. Observe the operating conditions and performance limits stated in the data sheet.

Target audience

Only connect, set up and use a power supply if you are an electrically skilled person. Electrically skilled persons have the relevant education and experience to enable them to perceive risks and to avoid hazards that electricity can cause.

This document targets at all users, including installers, operators, technicians, maintenance and service personnel.

Follow the safety instructions provided in [Chapter 1.1, "Safety instructions"](#), on page 9 and the additional information provided during setup or operation procedures.

Where do I find safety information?

Safety information is part of the product documentation. It warns you of potential dangers and gives instructions on how to prevent personal injury or damage caused by dangerous situations. Safety information is provided as follows:

- In [Chapter 1.1, "Safety instructions"](#), on page 9. The same information is provided in many languages as printed "Safety Instructions". The printed "Safety Instructions" are delivered with the product.
- Throughout the documentation, safety instructions are provided when you need to take care during setup or operation.

1.1 Safety instructions

Products from the Rohde & Schwarz group of companies are manufactured according to the highest technical standards. To use the products safely, follow the instructions provided here and in the product documentation. Keep the product documentation nearby and offer it to other users.

Use the product only for its intended use and within its performance limits. Intended use and limits are described in the product documentation such as the data sheet, manuals and the printed "Safety Instructions". If you are unsure about the appropriate use, contact Rohde & Schwarz customer service.

Only people skilled in electrical work should connect, set up and use the product. Such persons have the education and experience needed to recognize risks and avoid hazards of working with electricity. These users also need sound knowledge of at least one of the languages in which the user interfaces and the product documentation are available.

Reconfigure or adjust the product only as described in the product documentation or the data sheet. Any other modifications can affect safety and are not permitted.

Never open the casing of the product. Only service personnel authorized by Rohde & Schwarz are allowed to repair the product. If any part of the product is damaged or broken, stop using the product. Contact Rohde & Schwarz customer service at <https://www.rohde-schwarz.com/support>.

Lifting and carrying the product

Look up the maximum weight in the data sheet. A single person can only carry a maximum of 18 kg safely depending on age, gender and physical condition. If your product is heavier than 18 kg, do not move or carry it by yourself.

To move the product safely, you can use lifting or transporting equipment such as lift trucks and forklifts. Follow the instructions provided by the equipment manufacturer.

Choosing the operating site

Only use the product indoors. The product casing is not waterproof. Water that enters can electrically connect the casing to live parts, which can lead to electric shock, serious personal injury or death if you touch the casing.

Unless otherwise specified, you can operate the product up to an altitude of 2000 m above sea level. The product is suitable for pollution degree 2 environments where nonconductive contamination can occur. For more information on environmental conditions such as ambient temperature and humidity, see the data sheet.

Setting up the product

Always place the product on a stable, flat and level surface with the bottom of the product facing down. If the product is designed for different positions, secure the product so that it cannot fall over.

If the product has foldable feet, always fold the feet completely in or out to ensure stability. The feet can collapse if they are not folded out completely or if the product is moved without lifting it. The foldable feet are designed to carry the weight of the product, but not an extra load.

If stacking is possible, keep in mind that a stack of products can fall over and cause injury.

If you mount products in a rack, ensure that the rack has sufficient load capacity and stability. Observe the specifications of the rack manufacturer. Always install the products from the bottom shelf to the top shelf so that the rack stands securely. Secure the product so that it cannot fall off the rack.

Connecting to power

The product is an overvoltage category II product. Connect the product to a fixed installation used to supply energy-consuming equipment such as household appliances and similar loads. Keep in mind that electrically powered products have risks, such as electric shock, fire, personal injury or even death. Replace parts that are relevant to safety only by original parts, e.g. power cables or fuses.

Take the following measures for your safety:

- Before switching on the product, ensure that the voltage and frequency indicated on the product match the available power source. If the power adapter does not adjust automatically, set the correct value and check the rating of the fuse.
- If a product has an exchangeable fuse, its type and characteristics are indicated next to the fuse holder. Before changing the fuse, switch off the product and disconnect it from the power source. How to change the fuse is described in the product documentation.
- Only use the power cable delivered with the product. It complies with country-specific safety requirements. Only insert the plug into an outlet with protective conductor terminal.
- Only use intact cables and route them carefully so that they cannot be damaged. Check the power cables regularly to ensure that they are undamaged. Also ensure that nobody can trip over loose cables.
- Only connect the product to a power source with the safety fuse specified in the data sheet.
- Ensure that you can disconnect the product from the power source at any time. Pull the power plug to disconnect the product. The power plug must be easily accessible. If the product is integrated into a system that does not meet these requirements, provide an easily accessible circuit breaker at the system level.

Working with hazardous voltages

Voltages higher than 30 V RMS, or 42 V peak, or 60 V DC are regarded as hazardous contact voltages. Direct contact with them can cause serious injuries.

When working with hazardous contact voltages, use protective measures to preclude direct contact with the measurement setup:

- Before each measurement, inspect all components for damage and replace them if necessary.
- Do not touch exposed connections and components when power is applied.
- Casing, chassis and all measuring terminals are connected to a grounding connection. Never disconnect a grounding connection on the product.
- Switch off the power before connecting or disconnecting the terminal block to the rear panel connector. Tighten all wires connected to the terminal block.
- Only use the wires and terminal blocks delivered with the product.
- Only use insulated wires, not stripped wires, for the terminal connections.
- Turn the mains switch off when the product is not in use.

- When operating measuring accessories, only use the cables delivered with the accessory. If you have to use cables from other manufacturers, make sure that they are of the required overvoltage category.

Do not operate the product in series or parallel unless that setup is supported. If accessories are provided for a product, only use them for that product. See the data sheet.

In series or parallel setups, protect yourself against electric shock before connecting access ports such as the Ethernet port or the USB port using one of the following measures:

- Ensure that all products are grounded by connecting them to the AC power.
- Disconnect all power connections to the product, including outputs.

Measurement categories

IEC 61010-2-030 defines measurement categories that rate products on their ability to resist short transient overvoltages that occur in addition to the working voltage.





This product is designed for measuring within measurement category 0 only. Measurements in this category are performed on circuits not directly connected to mains, such as electronics, battery powered circuits, and specially protected secondary circuits. This measurement category is also known as CAT I.

Cleaning the product

Use a dry, lint-free cloth to clean the product. When cleaning, keep in mind that the casing is not waterproof. Do not use liquid cleaning agents.

Meaning of safety labels

Safety labels on the product warn against potential hazards.

	Potential hazard Read the product documentation to avoid personal injury or product damage.
	Electrical hazard Indicates live parts. Risk of electric shock, fire, personal injury or even death.
	Hot surface Do not touch. Risk of skin burns. Risk of fire.
	Protective conductor terminal Connect this terminal to a grounded external conductor or to protective ground. This connection protects you against electric shock if an electric problem occurs.





1.2 Labels on R&S NGC100

Labels on the casing inform about:

- Personal safety, see "[Meaning of safety labels](#)" on page 12.

- Product and environment safety, see [Table 1-1](#).
- Device information is provided on a sticker attached to the [rear panel](#) of R&S NGC100. The sticker contains a barcode and the device ID. The device ID is a combination of the order number and the serial number.

Table 1-1: Labels regarding R&S NGC100 and environment safety

	Labeling in line with EN 50419 for disposal of electrical and electronic equipment after the product has come to the end of its service life. For more information, see " Disposing of electrical and electronic equipment " on page 185.
	Grounding terminal (earth ground contact)
	ON (supply voltage)
	OFF (supply voltage)
	Chassis grounding terminal

1.3 Warning messages in the documentation

A warning message points out a risk or danger that you need to be aware of. The signal word indicates the severity of the safety hazard and how likely it will occur if you do not follow the safety precautions.

DANGER

Imminently hazardous situation. Will result in death or serious injury if not avoided.

WARNING

Potentially hazardous situation. Could result in death or serious injury if not avoided.

CAUTION

Potentially hazardous situation. Could result in minor or moderate injury if not avoided.

NOTICE

Potential risks of damage. Could result in damage to the supported product or to other property.

1.4 Korea certification class A



이 기기는 업무용(A급) 전자파 적합기기로서 판매자 또는 사용자는 이 점을 주의하시기
바라며, 가정외의 지역에서 사용하는 것을 목적으로 합니다.

2 Welcome to R&S NGC100

The one, two or three-channel power supply series are based on a classical transformer concept with linear regulators. This concept allows the instrument to achieve highest accuracy and lowest residual ripple.

Key features

All output channels of R&S NGC100 are galvanically isolated, floating and protected against overloading and short-circuit. Outstanding key features are:

- Parallel or serial connection to achieve higher voltage and current respectively
- Multi-purpose protection functions (FUSE, OVP, OPP) set separately for each channel
- Overtemperature protection function (OTP) against overheating for each channel
- Fuse link protection function against overcurrent for two or three-channel model
- EasyArb function for freely definable voltage and current sequences with a time-frame as short as 1 ms
- EasyRamp function to ramp up supply voltage within a defined timeframe of 10 ms to 10 s
- Sequencing starts of output channels and triggering input for starting and controlling of EasyArb function
- Various interfaces (USB, LAN (LXI), GPIB) for ease of remote connection
- Direct control of channel output voltage using analog input of 0 V to 5 V
- Sense control for each channel output

For more information, see the data sheet.

2.1 Documentation overview

This section provides an overview of the R&S NGC100 user documentation.

2.1.1 Manuals

You find the documents on the R&S NGC100 product page at:

www.rohde-schwarz.com/manual/ngc100

Getting started

Introduces the R&S NGC100 power supply series and describes how to set up and start working with the instrument. The printed document is delivered with the instrument.

2.1.5 Application notes, application cards, white paper, etc.

These documents contain information about possible applications and background information on various topics:

www.rohde-schwarz.com/application/ngc100

2.1.6 Remote control driver

The instrument drivers enable remote control via the corresponding interfaces. The drivers and installation instructions are available for download on the product page at:

www.rohde-schwarz.com/driver/ngc100

2.2 Conventions used in the documentation

2.2.1 Typographical conventions

The following text markers are used throughout this documentation:

Convention	Description
"Graphical user interface elements"	All names of graphical user interface elements on the screen, such as dialog boxes, menus, options, buttons, and softkeys are enclosed by quotation marks.
[Keys]	Key and knob names are enclosed by square brackets.
Filenames, commands, program code	Filenames, commands, coding samples and screen output are distinguished by their font.
<i>Input</i>	Input to be entered by the user is displayed in italics.
Links	Links that you can click are displayed in blue font.
"References"	References to other parts of the documentation are enclosed by quotation marks.

2.2.2 Notes on screenshots

When describing the functions of the product, we use sample screenshots. These screenshots are meant to illustrate as many as possible of the provided functions and possible interdependencies between parameters. The shown values may not represent realistic usage scenarios.

The screenshots usually show a fully equipped product, that is: with all options installed. Thus, some functions shown in the screenshots may not be available in your particular product configuration.

3 Getting started

3.1 Preparing for use

Here, you can find basic information about setting up the product for the first time.

3.1.1 Lifting and carrying

See "[Lifting and carrying the product](#)" on page 10.

3.1.2 Unpacking and checking

1. Unpack the R&S NGC100 carefully.
2. Retain the original packing material. Use it when transporting or shipping the R&S NGC100 later.
3. Using the delivery notes, check the equipment for completeness.
4. Check the equipment for damage and loose parts.

If the delivery is incomplete or equipment is damaged, contact Rohde & Schwarz.

See also [Chapter 11, "Transport"](#), on page 183.

3.1.3 Choosing the operating site

Specific operating conditions ensure proper operation and avoid damage to the product and connected devices. For information on environmental conditions such as ambient temperature and humidity, see the data sheet.

For safety information, see "[Choosing the operating site](#)" on page 10.

Electromagnetic compatibility classes

The electromagnetic compatibility (EMC) class indicates where you can operate the product. The EMC class of the product is given in the data sheet.

- Class B equipment is suitable for use in:
 - Residential environments
 - Environments that are directly connected to a low-voltage supply network that supplies residential buildings
- Class A equipment is intended for use in industrial environments. It can cause radio disturbances in residential environments due to possible conducted and radiated disturbances. It is therefore not suitable for class B environments.

If class A equipment causes radio disturbances, take appropriate measures to eliminate them.

3.1.4 Setting up the R&S NGC100

Adequate air circulation must be ensured during operation. For continuous operation, a horizontal or inclined position (integrated stand) is preferable.

See also:

- "Setting up the product" on page 10
- "Intended use" on page 9

3.1.4.1 Placing the R&S NGC100 on a bench top

To place the product on a bench top

1. Place the product on a stable, flat and level surface. Ensure that the surface can support the weight of the product. For information on the weight, see the data sheet.
2. **CAUTION!** Foldable feet can collapse. For safety information, see "Setting up the product" on page 10.

Always fold the feet completely in or out. With folded-out feet, do not place anything on top or underneath the product.

3. **WARNING!** A stack of products can fall over and cause injury. Never stack more than three products on top of each other. Instead, mount them in a rack.

Stack as follows:

- If the products have foldable feet, fold them in completely.
- All products must have the same dimensions (width and length).
- Do not exceed a total load of 50 kg placed on the product at the bottom of the stack.

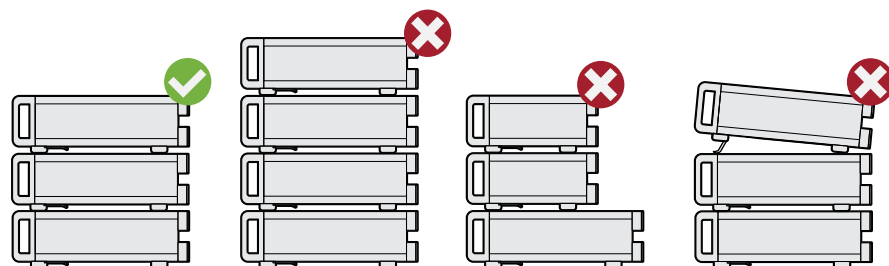

- Left = Stacked correctly
 Middle left = Stacked incorrectly, too many products
 Middle right = Stacked incorrectly, different dimensions
 Right = Stacked incorrectly, folded-out feet

4. **NOTICE!** Overheating can damage the product.

Prevent overheating as follows:

- Keep a minimum distance of 10 cm between the fan openings of the product and any object in the vicinity to provide sufficient airflow and ventilation.
- Do not place the product next to heat-generating equipment such as radiators or other products.

3.1.4.2 Mounting the R&S NGC100 in a rack

To prepare the rack

1. Observe the requirements and instructions in "[Setting up the product](#)" on page 10.
2. **NOTICE!** Insufficient airflow can cause overheating and damage the product.

The heat produced inside the instrument is guided to the exterior via temperature-controlled fan. The R&S NGC100 has multiple temperature sensors which check the heat generation in the instrument and control the fan speed.

It is necessary to ensure that there is sufficient space around the instrument sides for heat exchange. Ensure that fan openings and ventilation holes are unobstructed and airflow vents are unimpeded.

If the temperature inside the instrument increases more than the allowed limit, over-temperature protection is triggered and the affected outputs are switched off automatically.

To mount the R&S NGC100 in a rack

1. Use an adapter kit that fits the dimensions of the R&S NGC100 to prepare the R&S NGC100 for rack mounting.
 - a) Order the rack adapter kit designed for the R&S NGC100. For the order number, see data sheet.
 - b) Mount the adapter kit. Follow the assembly instructions provided with the adapter kit.
2. Lift the R&S NGC100 to shelf height.
3. Push the R&S NGC100 onto the shelf until the rack brackets fit closely to the rack.
4. Tighten all screws at the rack brackets with a tightening torque of 1.2 Nm to secure the R&S NGC100 at the rack.

To unmount the R&S NGC100 from a rack

1. Loosen the screws at the rack brackets.
2. Remove the R&S NGC100 from the rack.
3. If placing the R&S NGC100 on a bench top again, unmount the adapter kit from the R&S NGC100. Follow the instructions provided with the adapter kit.

3.1.5 Considerations for test setup

The product is built in compliance with DIN EN 61010-1 (VDC 0411 part 1), EN 61010-1 and IEC 61010-1. It is designed with the regulations of protection class 1, for supplying power-on circuits that are only indirectly connected to the low voltage mains or not connected at all.

The instrument is not intended for measurements within the measurement categories II, III or IV; the maximum potential against earth generated by the user must not exceed 250 VDC in this application.

See also "[Measurement categories](#)" on page 12.

General instrument specification

See [Table 3-1](#) for the general data on the instrument specification. Refer to the instrument datasheet for details.

Table 3-1: General data on instrument specification

Mains nominal voltage	AC	100 V _{AC} to 240 V _{AC} ($\pm 10\%$), 50 Hz / 60 Hz
Power consumption	Maximum input power	200 W
Mains fuses	100 V _{AC} to 240 V _{AC}	IEC 60127-2/5: T3.15H250V (fuse size: 5 mm x 20 mm)
Temperature	Operating temperature range	+5 °C to +40 °C
	Storage temperature range	-20 °C to +70 °C
Humidity	Non-condensing	5 % to 80 %
Display	-	3.5 " (QVGA)
Rack mount capability	-	19 " rack
Dimensions	W x H x D	97 mm x 222 mm x 291 mm (3.82 in x 8.74 in x 3.58 in)
Weight	R&S NGC101(-G)	2.6 kg (5.732 lb)
	R&S NGC102(-G)	
	R&S NGC103(-G)	

Operating limits

The R&S NGC100 is equipped with a protective overload feature. The protective overload feature prevents damage to the instrument and is intended to protect against a possible electrical shock. The maximum values for the instrument must not be exceeded. The protection limits are listed on the front panel of the R&S NGC100 to ensure safe operation of the instrument.

See [Table 3-2](#) for protection limits of the R&S NGC100.

Table 3-2: Protection limits for R&S NGC100

Specification	Limits	
Maximum output voltage	32 VDC	
Maximum output current	R&S NGC103(-G)	3 A
	R&S NGC102(-G)	5 A
	R&S NGC101(-G)	10 A
Maximum voltage against earth	250 VDC	
Maximum counter-voltage (same polarity)	33 VDC	
Maximum reverse voltage (opposite polarity)	0.4 VDC	
Maximum reverse current	3 A	
Power supply	100 VAC to 240 VAC (±10 %)	
Frequency	50 Hz / 60 Hz	
Maximum power output	100 W	

Cable selection and electromagnetic interference (EMI)

Electromagnetic interference (EMI) can affect the measurement results.

To suppress electromagnetic radiation during operation:

- Use high-quality shielded cables, for example double shielded USB and LAN cables.
- Use at least a CAT6+ LAN cables with a length ≤ 3 m and passive USB cable with a length ≤ 1m.
- Use insulated wires for output supply/terminal connections.
- Always terminate open cable ends.
- Ensure that connected external devices comply with EMC regulations.
- Check regularly that all cables, including power cables are in perfect conditions.

Signal input and output levels

Information on voltage levels is provided in the data sheet. Keep the voltage levels within the specified ranges to avoid damage to the product and connected devices.

See also "[Output terminals \(5\)](#)" on page 29.

3.1.6 Connecting to power

For safety information, see "[Connecting to power](#)" on page 11 and "[Working with hazardous voltages](#)" on page 11.

Before connecting the instrument to the mains, check whether the mains voltage conforms to the mains voltage range specified on the label located at the left of the [AC power connector](#).

The power supply module covers a wide power supply range and normally does not require adjustment. See [Table 3-1](#) for the supported mains voltage and the corresponding fuse types and ratings. If the power supply exceeds the permissible range, contact Rohde & Schwarz customer service.

1. Ground the R&S NGC100 using the ground terminal on the rear panel. See ["Ground terminal"](#) on page 23.
2. Plug the AC power cable into the AC power connector.
Use power cable that complies with the IEC 60320-1 standard.
3. Plug the AC power cable into a power outlet with ground contact.
The required ratings are listed next to the AC connector and in the data sheet.

Replacing the power fuse

By default, the R&S NGC100 is preloaded with a time lag fuse (IEC 60127-2/5: T3.15H250V). The fuse holder is located below the AC power connector.

1. Disconnect the product from the power source by removing the power cable from the power plug on the rear panel of the R&S NGC100.

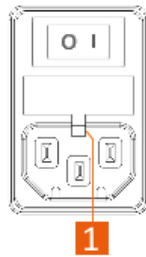



Figure 3-1: AC power connector

1 = Small notch of the fuse holder

2. Insert a flathead screwdriver in the small notch at the top of the fuse holder.
3. Lever out the fuse holder with the screwdriver.
4. Check the fuse rating on the caps of the fuse that you want to replace.
5. Once verified, insert the fuse into the groove of the fuse holder.
6. Return the fuse holder to its position in the panel.
The fuse holder is inserted against the spring pressure until it locks into place.

Ground terminal

If necessary, ground the instrument using the grounding connection  located at the [rear panel](#):

1. Unscrew the screw of the ground terminal using a cross-recess screw driver.
2. Attach a ground cable with a ring terminal and pass the screw through it.

3. Fasten the screw with a tightening torque of 1.2 Nm.
4. Connect the cable to ground.

3.1.7 Switching on or off



Specifications with tolerance data apply after a warm-up period of at least 30 minutes at a temperature of 23 °C (tolerance -3 °C / +7 °C).

See also [Chapter 3.1.6, "Connecting to power"](#), on page 22.

Switching on the product

The product is off but connected to power.

1. Set the switch on the power supply to position [I].
For the location of the switch, see [Chapter 3.2.2, "Rear panel"](#), on page 30.
The LED of the [Power] key is lighted red.
2. Press the [Power] key on the [front panel](#) of the R&S NGC100.
The LED of the [Power] key turns off.
The instrument performs a system check, boots the operating system and starts the R&S NGC100 firmware.
By default, the output channel is turned off when the instrument is switched on to prevent connected loads from being damaged unintentionally.
During startup, the R&S NGC100 is loaded with the last saved instrument settings.
See [Chapter 6.1, "Save and recall"](#), on page 94 in the user manual.

To shut down the product

- ▶ Press the [Power] key.
All current settings are saved and the operating system shuts down. The LED of the power key changes to red.

To disconnect from power

The product is in the standby state.

1. **NOTICE!** Risk of data loss. If you disconnect the product from power when it is in the ready state, you can lose settings and data. Shut it down first.
Set the switch on the power supply to position [0].
The LED of the [Power] key is switched off.
2. Disconnect the product from the power source.

3.1.8 Connecting to LAN

Establishing the LAN connection

The R&S NGC100 provides Ethernet (LAN) connectivity. Provided the corresponding rights are assigned, you can use these interfaces for remote control and data transfer from a controller PC. The controller PC must also be connected in the network.

The LAN connector is at the [rear panel](#) of R&S NGC100.

To connect R&S NGC100 to the LAN:

1. **NOTICE!** Recommendation on secure operation. The R&S NGC100 is designed to operate at local workplaces or in secured networks (LAN). It should not be accessible from the internet because of a potential security risk, e.g. attackers could misuse or damage your device.

Always install the latest firmware.

By default, the R&S NGC100 configuration uses DHCP that assigns the IP address automatically.

2. Connect the LAN socket using an RJ-45 cable to the LAN.
3. **NOTICE!** If the R&S NGC100 cannot obtain an IP address automatically, or cannot establish the connection, the "Link" status shows "no" in the [Figure 3-2](#). Possible reasons are that the LAN does not support DHCP or requires a specific TCP/IP configuration, or that the connection is missing.

To troubleshoot the problem, proceed as follows:

- a) Check if you have connected both, the R&S NGC100 and the controller PC to the LAN.
- b) Consult your network administrator to request support for an IP address, if necessary.
- c) If necessary, assign the IP address manually as described in [Chapter 8.1.1, "LAN interface"](#), on page 114.

If switched on and connected, the R&S NGC100 indicates the address information and LAN parameters in the Ethernet setting dialog. See [Figure 3-2](#).

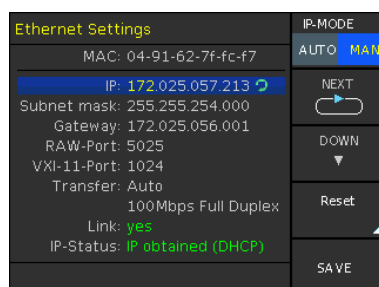

Figure 3-2: Ethernet settings dialog

3.1.9 Connecting USB devices

The USB Type-A connector is at the [front panel](#). You can connect or disconnect all USB devices from the R&S NGC100 during operation. But do not remove an external USB memory stick while the instrument is performing firmware update, data logging and storing of screen captures, since it leads to unsuccessful updates and loss of data.

To connect USB storage devices

USB storage devices, such as memory sticks, allow easy data transfer from or to the R&S NGC100. You can also use them for firmware updates.

- ▶ Connect the USB storage device to the USB type A connector.
If you use the front panel connectors, connect the USB storage device directly, without connecting cable. Connecting cables can cause electromagnetic radiation and impair the measurement result.

3.2 Instrument tour

The following sections help you to get familiar with the instrument and perform the first steps:

- [Chapter 3.2.1, "Front panels"](#), on page 26
- [Chapter 3.2.2, "Rear panel"](#), on page 30

The sections explain the controls and connections on the front and rear of the R&S NGC100. For specifications of the interfaces, see the data sheet.

The meanings of the labels on the R&S NGC100 are described in [Chapter 1.2, "Labels on R&S NGC100"](#), on page 12.

3.2.1 Front panels

Depending on the instrument models, the number of channels and controls on front panel varies. The following front view description introduces each model individually. The function keys and navigation controls are located at the right side of the display with various output terminals located below the display and function keys.

Table 3-3: Power supply models

Power supply model	Number of output terminals
R&S NGC103(-G) (0 V - 32 V / 3 A)	6 x 4 mm safety socket output terminals (maximum 100 W output / 33 W per channel)
R&S NGC102(-G) (0 V - 32 V / 5 A)	4 x 4 mm safety socket output terminals (maximum 100 W output / 50 W per channel)
R&S NGC101(-G) (0 V - 32 V / 10 A)	2 x 4 mm safety socket output terminals (maximum 100 W output) with S+ and S- sense connectors for compensating the line resistance

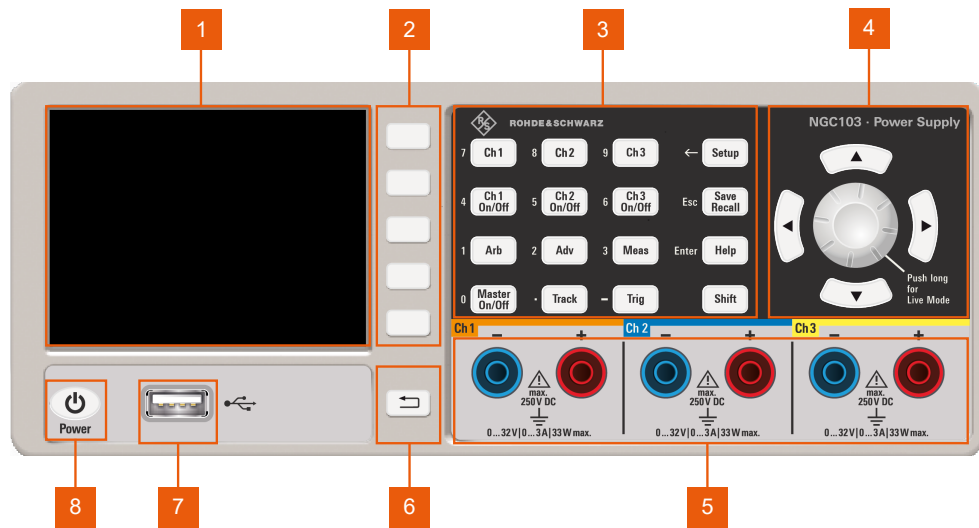

Figure 3-3: R&S NGC103(-G) front panel

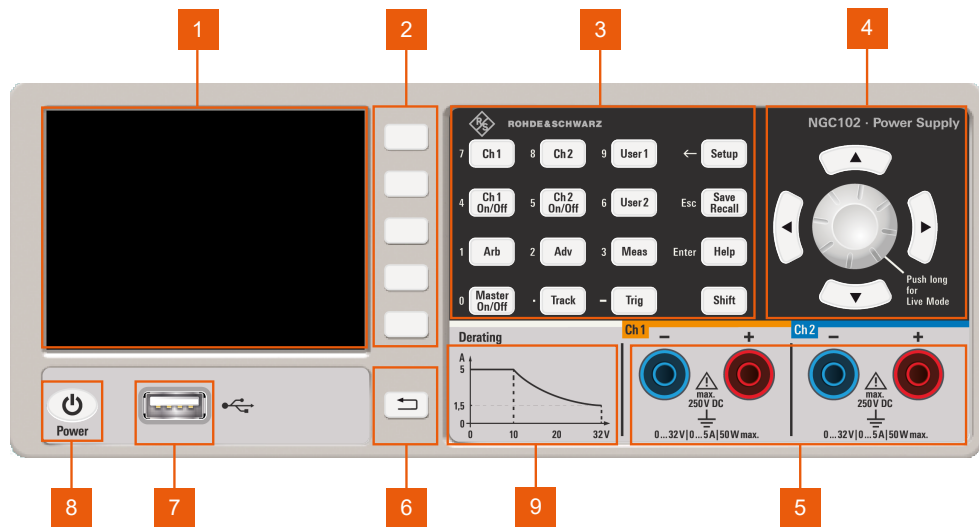

Figure 3-4: R&S NGC102(-G) front panel

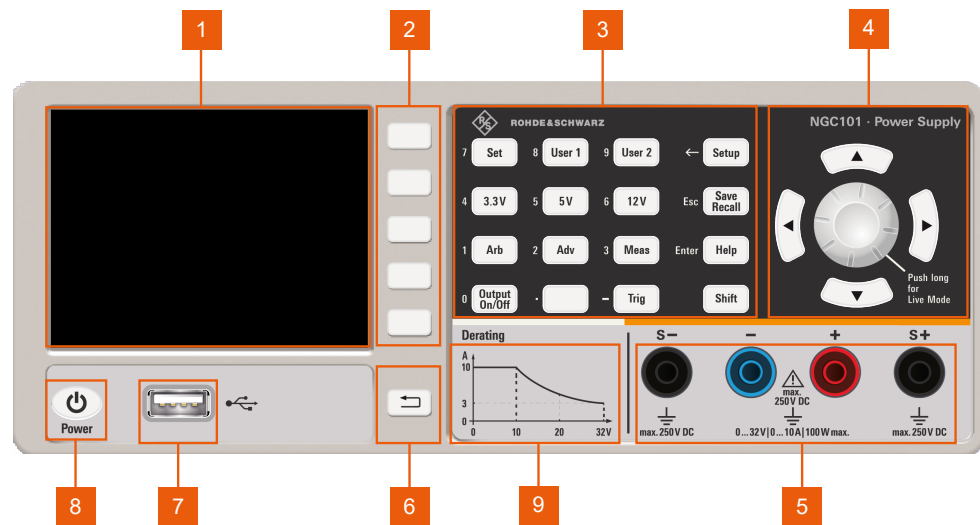

Figure 3-5: R&S NGC101(-G) front panel

- 1 = Display
- 2 = Interactive softkeys
- 3 = Function keys
- 4 = Navigation controls
- 5 = Output terminals
- 6 = Back key
- 7 = USB connector
- 8 = Power key
- 9 = Derating graph

Display (1)

The display is a color LCD screen. Depending on the instrument models, up to three channels are shown on the screen layout with different result fields are displayed. The respective measurement settings and functions are displayed in the individual channel section. There is a status bar at the top and bottom of each channel section to indicate the function used and operation modes of the instrument.

For a detailed description on-screen layout, see [Chapter 3.4.2.1, "Understanding the display information"](#), on page 36.

Interactive softkeys (2)

The interactive softkeys on the right of the display set the view of the measuring mode and provide access to submenus and functions.

The interactive softkeys are not illuminated.

If your instrument model does not support a specific operating mode, function or parameter, the access area to the interactive softkey menu is dimmed. See [Figure 3-12](#).

Function keys (3)

The function keys are means of input for manual operation of the instrument settings and functions. For detailed description on function keys, see chapter "Function keys" in the user manual.

Navigation control (4) (6)

The navigation controls include a rotary knob, arrow keys and [BACK] key. These keys are means of navigation and adjustment. When pressed or rotated, they perform tasks like navigation around the screen, adjustment of parameter values or confirmation of entries.

For detailed description on the navigation controls, see [Chapter 3.4.2, "Means of manual interaction"](#), on page 35.

Output terminals (5)

Depending on the instrument models, up to 6 x 4 mm safety sockets output terminals are available. See [Table 3-3](#).

USB connector (7)

USB Type-A connector is provided for connecting a USB flash drive to perform firmware update, data logging and store screen captures.

The USB flash drive file system supports a maximum capacity of up to 4GByte, FAT32 only. See also [Chapter 3.1.9, "Connecting USB devices"](#), on page 26.

Power key (8)

The [Power] key switches the instrument from the standby to the ready state or vice versa.

The LED of the [Power] key indicates the instrument state, see [Chapter 3.1.7, "Switching on or off"](#), on page 24.

Table 3-4: Power key state

Power key state	Descriptions
Power on, ready state.	The LED turns off. The instrument is ready for operation.
Power on, standby mode.	The LED turns red. The instrument is connected to power.
Power off or booting state.	The LED turns off during startup and operation, or when the instrument is not connected to the mains.

Derating Graph (9)

Imprinted on model R&S NGC101(-G) / R&S NGC102(-G), the derating graph shows the derating curve of current quoted as a function of voltage at maximum output power schematically.

For a detailed description, see [Chapter 4.2, "Power derating"](#), on page 51.

3.2.2 Rear panel

On the rear, the instrument models do not vary in design significantly. Therefore, the description refers to all models and points out existing differences.

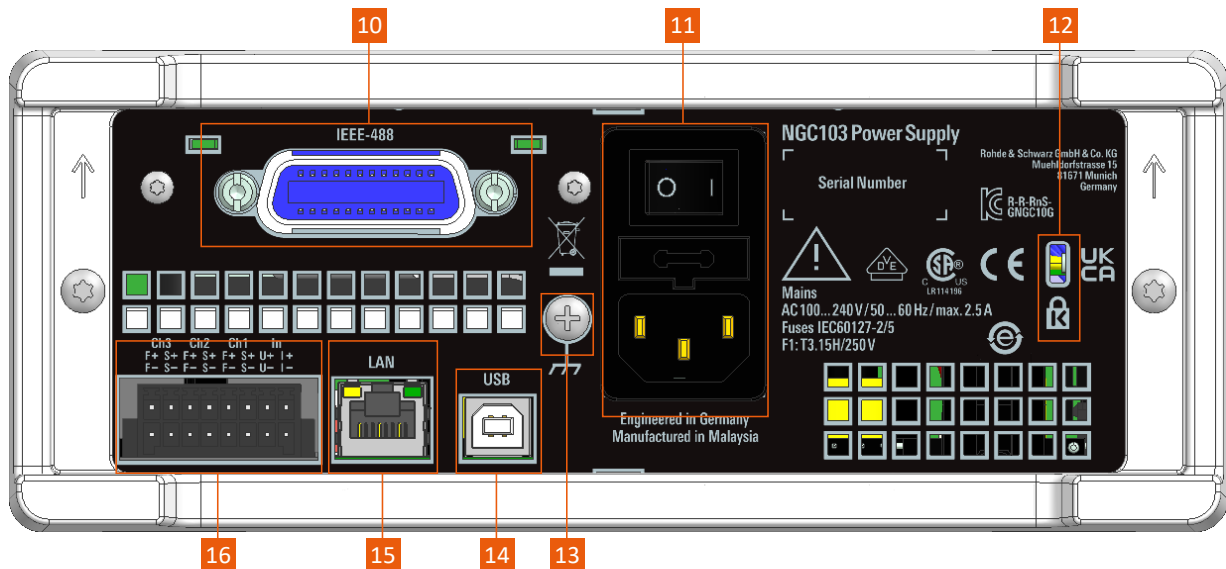

Figure 3-6: R&S NGC100 rear panel

- 10 = IEEE-488 (GPIB) interface
- 11 = AC power supply
- 12 = Kensington lock
- 13 = Ground terminal
- 14 = USB interface
- 15 = Ethernet (LAN) interface
- 16 = Rear panel connector

IEEE-488 (GPIB) interface (10)

Available with variant 03 model (i.e. 3657.xxxx.03), this general-purpose interface bus (GPIB) interface provides remote control of the instrument.

Use this interface to connect a computer for remote control of the R&S NGC100. To set up the connection, use high-quality shielded cables.

For more information, see chapter [Chapter 8.1, "Remote control interfaces and protocols"](#), on page 112 in the user manual.

AC power supply (11)



Main supply cord

Use a detachable mains supply cord according to IEC60320-1 standard.

The power cable must be plugged in before signal circuits can be connected. Never use the product if the power cable is damaged.

Mains power supply with power switch, fuse holder and IEC socket.

- Mains power switch
Switch for connecting and disconnecting the internal power supply from the power source, see [Chapter 3.1.7, "Switching on or off"](#), on page 24.
- Fuse holder
Socket for the fuse securing the line voltage. The fuse is factory fitted. See ["Replacing the power fuse"](#) on page 23.
- IEC socket
Power supply connector for connecting the R&S NGC100 to the mains, see [Chapter 3.1.6, "Connecting to power"](#), on page 22.

Kensington lock (12)

A Kensington lock can be anchored to the R&S NGC100 power supply housing to secure it to a workstation mechanically.

Ground terminal (13)

Protective ground terminal to secure the R&S NGC100, e.g. with a ground external conductor, see [Chapter 1.2, "Labels on R&S NGC100"](#), on page 12.

USB connector (14)

The USB connector is a Type-B connector for remote control operation via USB TMC or USB VCP.

For more information, see [Chapter 8.1.2, "USB interface"](#), on page 118.

Ethernet connector (15)

This RJ-45 connector is used for establishing remote control via SCPI. For more information on the connection setup, see [Chapter 3.1.8, "Connecting to LAN"](#), on page 25

Rear panel connector (16)

Rear panel outputs for integration into 19" rack systems.

NOTICE

Output terminals

Either the output terminals at the front panel or the rear panel connector at the back panel can be used.

Both terminals cannot be used at the same time as it can cause the instrument to malfunction.

Depending on the instrument models, the rear panel connector contains both output ("F+", "F-") and sense ("S+", "S-") connections for the supported channels. To connect lines, use the supplied plug-in terminal block connector which allows easy integration into 19" rack systems.

Available only for R&S NGC102(-G) and R&S NGC103(-G) models, the SENSE lines allow you to compensate voltage drops on the supply lines to the load so that the actual selected voltage is applied to the load.

The instrument automatically detects when the SENSE lines are connected and it regulates the output voltage directly at the load. If the SENSE lines are connected via S+ and S-, the display shows SENSE. The maximum compensation value of the lead resistances is 1 V.



Figure 3-7: Terminal block with connector assignment

F+ = Corresponds to + socket on the front panel
 F- = Corresponds to - socket on the front panel
 S+, S- = SENSE connectors
 U+, U- = Voltage interface or external trigger input
 I+, I- = Current interface

1. **DANGER!** Shock Hazard. Risk of electric shock if AC power is turned on when connecting wires to the rear panel connector.
Turn off AC power when connecting wires to the rear panel connector.
2. Insert shielded wire to the pluggable terminal block.
3. Tightened all the wires with the screw on the pluggable terminal block.
4. Connect the pluggable terminal block to the output terminal.

3.3 Trying out the instrument

This chapter describes some basic functions that you can perform with the R&S NGC100.

3.3.1 Selecting the channels

For R&S NGC102(-G) and R&S NGC103(-G) models, select a channel by pressing the corresponding channel key. The selected channel key illuminates.

3.3.2 Setting the output voltage and current limits

To set the output voltage and current limit via live-mode:

1. Long press the rotary knob to enter into editing mode.
By default, the voltage at channel 1 is selected.
2. Use arrow keys to select the desired parameter (voltage or current).
Selected voltage or current of the respective channel is highlighted.
3. Rotate the rotary knob to adjust value.
4. To exit live-mode, press the rotary knob.

Alternatively:

1. For R&S NGC102(-G) and R&S NGC103(-G) models, press the desired channel key (i.e. [Ch1]) on the front panel.
For R&S NGC101(-G) model, press [SET] key on the front panel.
The channel menu is displayed.
2. Press the respective softkey to set the voltage or current limit setting of the selected channel. The value on the selected channel becomes editable and is positioned by a white cursor.
All arrows keys on the navigation control are illuminated.
3. Press the [Left] / [Right] arrow key to move the cursor.
4. Press the [Up] / [Down] arrow key to change the value.
Alternatively, turn the rotary knob to change the value.
The new value registers immediately.
5. To directly set the numerical values, press the [Shift] key on the front panel. The [Shift] key switches the function keys to a numeric keypad to change the value.



Figure 3-8: Numeric keypad

- a) Select a desired channel key followed by the softkey to set voltage or current limit ("U" or "I").
- b) Press [Shift] key.
The input entry field is displayed.

- c) Enter the desired value using the numeric keypad on the front panel. See [Figure 3-8](#).
- d) Press the respective softkey to confirm entry with the unit ("mV" or "V" for voltage and "mA" or "A" for current).
Alternatively, press the rotary knob to confirm entry with the default unit.
The new value registers immediately.

3.3.3 Activating the channel output

The output voltages can be switched on or off regardless of the operating mode of the instrument.

To activate the channel output, press the [Master On/Off] key on the front panel followed by the desired channel on/off key (i.e. [Ch 1 on/off]) or vice versa.

For R&S NGC101(-G) model, press the [Output On/Off] key to activate the channel output.

Depending on the instrument operating mode, the display font color changes to green in CV (constant voltage) mode and red in CC (constant current) mode.

By default, the output is turned off when the instrument is switched on.

See also "[Operating modes](#)" on page 39.

3.3.4 Storing/Recalling of instrument settings

The R&S NGC100 can store instrument settings and screenshots. Out of these data types, screenshots can only be stored on a USB stick. Instrument settings can be stored on a USB stick or internally in the instrument to non-volatile storage media.

1. Press [Save Recall] > "Device Settings" > "SAVE" key to store instrument settings.
2. Select the desired storage location, filename and comment (if any).
Default filename SETxxxxx is used if no filename is entered where "xxxx" refers to the incremental index starting from "0001".
3. Confirm the selection by selecting the "SAVE" softkey.
The instrument settings are saved.
4. Press [Save Recall] > "Device Settings" > "LOAD" key to load or delete instrument settings.
5. Select the desired file location and filename.
The file manager dialog of the selected location is displayed.
6. Select "LOAD" to load the instrument settings.
The selected instrument settings are loaded.
7. Select "Delete file" to delete the instrument settings.
The selected instrument settings are deleted.

To retrieve the factory default settings, press [Save Recall] > "Device Settings" > "Default Settings" to load back the factory default settings.

3.4 Instrument control

This chapter provides an overview on how to work with the R&S NGC100. It introduces the possibilities for operating the instrument and describes the basic functionality of the control elements. If a measurement configuration requires specific operating steps, the corresponding settings description in the user manual points it out separately.

- [Ways to operate the instrument](#)..... 35
- [Means of manual interaction](#)..... 35
- [Remote control](#)..... 44

3.4.1 Ways to operate the instrument

You can operate an R&S NGC100 in two ways:

- **Manual operation**
Use the front panel controls to configure the R&S NGC100 settings.
See [Chapter 3.4.2, "Means of manual interaction"](#), on page 35 for basic information on manual operation of the instrument.
- **Remote control**
Create programs to automatize repeating settings, tests and measurements. A controller PC with remote access to the instrument runs the programs.
See [Chapter 3.4.3, "Remote control"](#), on page 44 for an overview of the interfaces provided for remote control.



3.4.2 Means of manual interaction

To configure the R&S NGC100 manually, use the front panel controls, see [Chapter 3.2.1, "Front panels"](#), on page 26. The display shows the current settings, menus and dialogs, when you perform your settings.

For manual interaction with the R&S NGC100, you have several methods that you can use as an alternative to perform a task:

- **Function keys, interactive keys and menus**
The front panel function keys followed by the corresponding interactive keys provide nearly all the functions and controls needed to operate the instrument. When selected, i.e. a function is active, the corresponding function key lights up in white. You can access to the different instrument functions and parameters settings, operating modes and configure general instrument settings.
- **Navigation controls**
The navigation controls include a rotary knob, arrow keys ([Up], [Down], [Left], [Right]) and  [Back] key.

The arrow keys when lights up allow you to navigate on the channel display area or dialogs and menus to set parameters. The rotary knob when pressed acts like the [ENTER] key.

In menus, the  [Back] key returns the menu to the previous level or closes the menu from the first level. In the alphanumeric entry, the  [Back] key allows you to abort changes made in the entry field.

For basic instructions on how to control the R&S NGC100, see [Chapter 3.4, "Instrument control"](#), on page 35.

3.4.2.1 Understanding the display information

Depending on the instrument models, up to three channel display area are shown on the screen layout. Each channel display area displays the voltage, current values and the operating mode and functions of the output. For all models, the display shows a device status bar at the top of the display and the supported channel display area at the bottom. On the right-hand side of the screen layout, an interactive softkey menu set the view of measuring mode and provides access to the selected measurement functions and settings.

The result fields display on the screen layout depend on the instrument models:

- The statistic readings of minimum, maximum, mean and count values for voltage and current are displayed simultaneously on R&S NGC101(-G) and R&S NGC102(-G) models. For R&S NGC103(-G) model, the statistic function is available in the background and is accessed via the [MEAS] > "STATS" softkeys.
- For R&S NGC101(-G) model, the channel display area is divided into the section of "Set" and "Meas" (sense) display channel area. Below the "Meas" display channel area is the display of statistic readings of minimum, maximum, mean and count values for voltage and current.

For more information of statistic function, see ["Statistic function"](#) on page 39.

Table 3-5: Screen layout of R&S NGC100 models

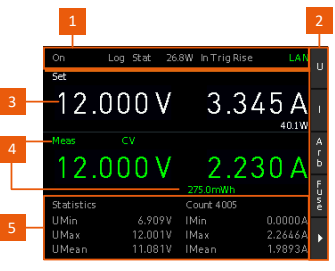
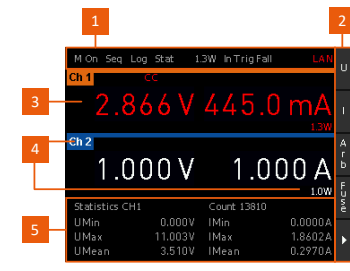
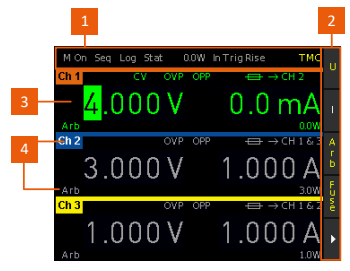
R&S NGC101(-G)	R&S NGC102(-G)	R&S NGC103(-G)
		
<ul style="list-style-type: none"> • 1 = Device status bar • 2 = Interactive softkey menus (e.g. Track menu) • 3 = Channel display area • 4 = Channel status bar • 5 = Statistic function 		

The following sections explain the information areas as labeled.

Status bar information

There are two types of status bar information located in the screen layout:

- [Device status](#)
- [Channel status](#)

Device status

The device status bar indicates the master on/off status, the current power consumption and the state of the selected interfaces and functions.



Table 3-6: Device status bar information

Function	Description
"M On" "M Off"	Master output state. The instrument master output state to switch on the output supply.
"Seq"	Measurement function: Sequencing. Provides adjustable time offsets on consecutively connected channels when outputs are switched on (Master on/off).
"Log"	Measurement function: Data logging. Provides capturing and storage of measurement values.
"Stat"	Statistic reading of minimum, maximum, mean and count values for voltage and current.
<W>	Displays total power consumption.
"In TrigRise" "In TrigFall" "In An U" <%> "In An I" <%>	Signal input type and settings. The signal input type can be a trigger signal ("Rise" or "Fall") or an external analog input signal to control the output level of voltage ("U") or current ("I") in percentage <%>.
"LAN" "USB" "GPIB"	Remote control interface. Depending on instrument models, three different remote control interfaces are supported: LAN, USB ("VCP" or "TCM") and GPIB for remote operating of the instrument.

Channel status

The channel status displays the state of the indicators available in the device channel. It is shown at the top and bottom section of each channel display area.



Figure 3-9: Example of a three-channel power supply

Table 3-7: Channel status bar information

Indicator	Description
<Channel> "Set" and "Meas"	Channel number indication. Depending on instrument models supported, up to three channels ("Ch1", "Ch2", "Ch3") are displayed. For R&S NGC101(-G) model, the top channel display area displays the configured or "Set" voltage and current settings and the bottom channel display area displays the sense or "Meas" voltage and current settings. See Table 3-5 .
CV / CC	Instrument operating mode: CV (constant voltage), CC (constant current).
OVP / OPP	Indicator to show that the overload voltage or power protection is activated. When triggered, the indicator shows flashing and displays in red.
	Symbol indicates that the electronic fuse is activated. When the fuse is tripped, the symbol shows flashing and displays in red.
Fuse linking (e.g. → CH2 & 3)	Depending on instrument models, up to two channels can be linked if a fuse tripped event occurs, e.g. → CH2 & 3 can be linked to "Ch2" & "Ch3" for R&S NGC103(-G) model.
Arb	Program arbitrary output sequences.
In An	If activated, the instrument output (voltage or current) is externally controlled using voltage signal (0 V to 5 V analog input corresponds to 0 to V_{max} or I_{max}).
Ramp	If activated, output voltage to ramp continuously within a 10 ms to 10 s until the set voltage, V_{set} .
Energy meter (Wh)	If activated, it displays the energy released at the output in Ws.
Power	Displays maximum output power in watt.

Channel display area

The channel display area shows the voltage and current values and the corresponding mode (CC, CV) of the R&S NGC100 when the device output is turned on. See "[Operating modes](#)" on page 39 for the different operating modes that the R&S NGC100 supported.

Statistic function

At the bottom of the screen layout is the display of statistic values (minimum, maximum, mean and count) for voltage and current for each channel. In the case of R&S NGC101(-G) and R&S NGC102(-G) models, the statistic values are only determined individually for each channel.

The R&S NGC103(-G) model does not allow the simultaneous display of the statistic values, it is run in the background. To access it, press [MEAS] > "STATS" to display the statistic menu to turn on/off or reset the display. The statistic values are determined individually for each channel.

For details, see [Chapter 5.9.1, "Statistics"](#), on page 71.

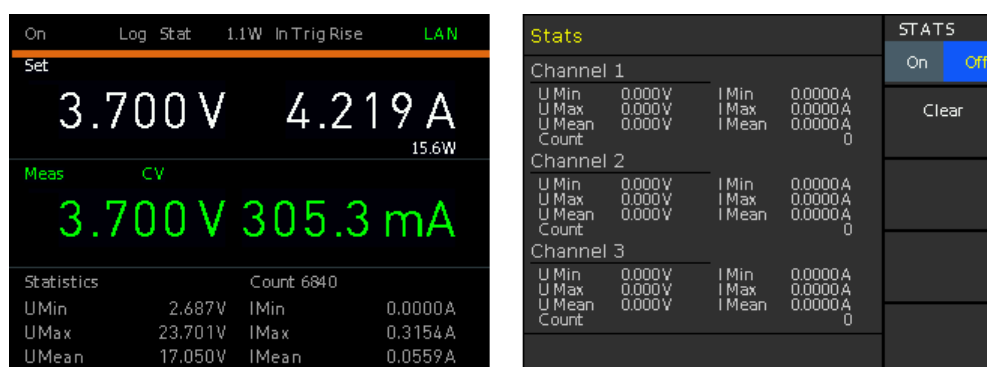

Figure 3-10: Statistic display of a R&S NGC101(-G) and R&S NGC103(-G) model

Operating modes

Different font colors on the screen are used to differentiate the various output status and operating conditions of the instrument. It is easy to know and confirm the different output status and operating conditions of the instrument by looking at the colors.

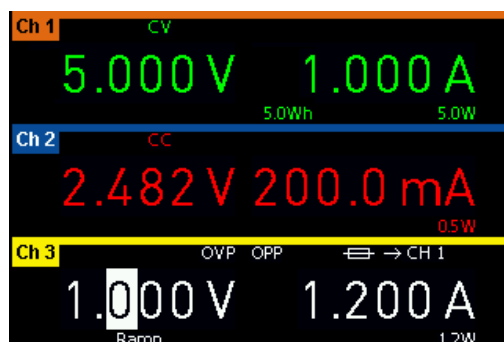

Figure 3-11: Color coding of difference operating conditions

Color	Operating mode	Description
□	OFF mode or editing mode	Output is OFF. In editing mode, a solid white cursor is shown when an item is selected.
■	CV mode	Active outputs are operated in a constant voltage mode. Label "CV" is displayed at the top left-hand corner below channel number.
■	CC mode	Active outputs are operated in a constant current mode. Label "CC" is displayed at the top left-hand corner below channel number.

Additional display characteristics

The following section provides a short insight on the indication of the screen in general for dialogs or settings.

- Appearance of active elements in dialogs or settings
 - Elements selected have a blue background. For unavailable settings of functions, the selection shows dimmed. See [Figure 3-12](#).
 - Parameters with a rotary icon indicate operation with rotary knob. Alternatively, you can use respective softkey for selection.



Figure 3-12: Appearance of active elements

- Information indicated in red denotes that the setting is inactive or erroneous.
- "---" dashes on the display indicate that the R&S NGC100 could not determine a value.
- Menus and dialogs

Menu and dialogs are accessible via the correspond function key on the front panel followed by the respective interactive softkey. See [Chapter 3.2.1, "Front panels"](#), on page 26.

When pressed, the R&S NGC100 displays the menu of the selected function at the side of the screen display. See [Figure 3-13](#).

For more information on the function keys, see [Chapter 4.1.1, "Function keys"](#), on page 46.



Figure 3-13: Example of a menu selection (highlighted)

The term dialog refers to the views that cover the parameters of a certain function.

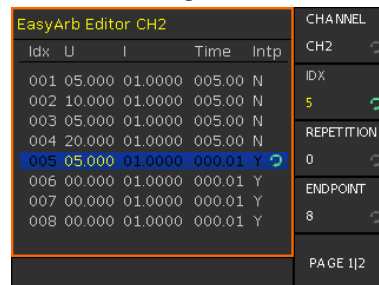

Figure 3-14: EasyArb editor dialog

- On-Screen keypad

The on-screen keypad appears if alphanumeric entry field is required. See ["Entering alphanumeric parameters"](#) on page 44.

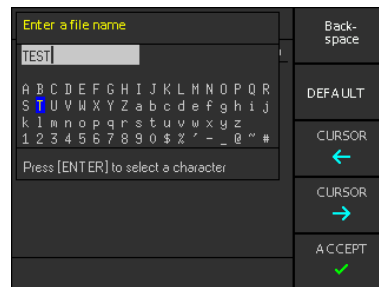

Figure 3-15: On-screen keyboard

- "Fallback" time, an adjustable time period:

When this time period has elapsed, the instrument either closes a setting dialog, returns to a previous dialog or assigns a certain setting automatically without having confirmed manually.

Settings in menus are not affected by the fallback time.

See [Chapter 7.3.5, "Key brightness"](#), on page 107.

3.4.2.2 Accessing the functionality

All functionalities of the R&S NGC100 are provided by the corresponding function key followed by the interactive softkey on the front panel. This section provides an overview of the accessing methods. For detailed information, see [Function Keys](#).

Apart from the main menu, we use the term "dialog" to refer the editable windows in the instrument.

To open the menu and submenu using interactive softkey

1. Press the desired function key followed by the corresponding interactive softkey at the front panel.
The respective instrument menu is displayed.
See [Figure 3-13](#).
2. Menu item with icon  (white arrow tag) at the bottom indicates that there is submenu available for selection.
Press the corresponding interactive softkey to go to submenu.
The submenu of the instrument is displayed.

To close or exit a dialog or menu

- ▶ Press  [Back] key at the front panel.
The instrument returns to previous menu level or exit the menu mode if it is already at the main menu level.

To select a parameter in a dialog

All except the arbitrary editor dialog have its parameters fixed at the softkey menu for selection. Use the respective softkey on the front panel for setting the parameters in the dialog.

For arbitrary editor dialog, the number of "ENDPOINT" indicates the available rows of data for selection. See [Figure 3-14](#).

1. Press the [UP] / [DOWN] arrow key to navigate the rows of data for selection.
2. Press the [LEFT] / [RIGHT] arrow key to navigate the items in the row for settings.
3. Rotates the rotary knob or use the numeric keypad ([SHIFT] key) to adjust settings.
4. Press the rotary knob (e.g. [ENTER] key) to confirm your selection.
5. To add more rows of data for editing, select the "ENDPOINT" softkey item to set the row.

To go into live-mode

In live-mode, the instrument automatically sets the voltage at channel 1 to editing mode. Duration of the live-mode depends on the key fallback time. Set a longer key fallback time if you need more time in this mode.

For information on key fallback time, see [Chapter 7.3.5, "Key brightness"](#), on page 107.

For more information on live-mode operation, see [Chapter 3.3.2, "Setting the output voltage and current limits"](#), on page 33.

3.4.2.3 Entering data

Data can be entered using one of the following methods:

- Using the navigation controls on the front panel, e.g. rotary knob, arrow keys.
The rotary knob has several functions:
 - Moves the selection, e.g. to a parameter in a settings dialog by turning clockwise or counterclockwise.
 - Activates the edit mode of a parameter when pressed.
 - Acts like the [ENTER] key when it is pressed.
 - Increments (by turning clockwise) or decrements (counterclockwise) a numeric parameter.
 - Resets decimal digits to the right of the cursor when it is pressed and held.
E.g. Voltage value 10.028 V with cursor on 2nd decimal digit, press and hold the knob until the instrument sets the subsequent decimal digits to 0 (10.020 V).
- Using the [SHIFT] key on front panel to directly set the numerical values.
See ["Entering numeric parameters"](#) on page 43.
- Using on-screen keyboard for alphanumeric input field in the dialog.

Entering numeric parameters

If the input field requires numeric input, you can use either the rotary knob or arrow keys on the front panel to adjust to required values. Alternatively, using the [SHIFT] key on front panel to directly set the numerical values. See [Figure 3-8](#).

To correct value in the dialog or menu

1. Rotate the rotary knob to increase (clockwise direction) or decrease (counter-clockwise direction) to the required value.
2. Alternatively, use [SHIFT] key on front panel for direct setting of numeric values.
See [Figure 3-8](#).
3. Press the rotary knob to confirm the value with default unit or select the respective softkey for unit to confirm the entry.

To correct value in the channel display area

1. Select the corresponding function key at the front panel, e.g. [Ch1] followed by "Voltage" softkey for voltage setting.
2. Press the [Left] / [Right] arrow key to position at the entry point for correction.
3. Rotate the rotary knob to increase (clockwise direction) or decrease (counter-clockwise direction) to the required values.

4. Alternatively, use the [Up] arrow key to increase and [Down] arrow key to decrease to the required value. For directly setting of numeric values, use [SHIFT] key on front panel. See [Figure 3-8](#).

To complete the entry

- ▶ Press the rotary knob.
For directly setting of numeric values, you can complete the entry with a selection of unit softkeys or using default unit by pressing the rotary knob.

Entering alphanumeric parameters

If a field requires alphanumeric input, you can use the on-screen keyboard to enter letters and (special) characters. See [Figure 3-15](#).

To enter and confirm an entry

1. Rotate rotary knob to select the desire character to enter.
2. Press the rotary knob to confirm entry.

To correct an entry

1. To delete an entry, use "CURSOR ->" or "CURSOR <-" softkey to set the cursor to the right of the entry you want to correct.
2. Select "Backspace" softkey to delete the entry to the left of the cursor.
3. Enter your correction.

To complete the entry

- ▶ To confirm the entry, select "ACCEPT" softkey to confirm the input.
The R&S NGC100 returns to a previous level in menu of closes a view.

To abort the entry

- ▶ Press  [Back] key at the front panel.
The dialog closes without changing the settings.

3.4.3 Remote control

In addition to operating the R&S NGC100 directly on the instrument, it is also possible to operate and control it from a remote PC.

Remote control interfaces

The R&S NGC100 provides several interfaces for remote control:

- Ethernet (LAN) interface
- USB standard interface

For detailed information on how to configure the remote control interfaces, see [Chapter 8.1, "Remote control interfaces and protocols"](#), on page 112.

See [Chapter 3.1.8, "Connecting to LAN"](#), on page 25 for an example of how to set up LAN connection for remote control.

4 Operating basics

4.1 Front panel keys

Depending on the instrument models, the front panel keys are positioned differently. For an overview of the front panel keys, see [Chapter 3.2, "Instrument tour"](#), on page 26.

4.1.1 Function keys

The following keys can be categorized based on their functions.

Table 4-1: Categorization of function keys

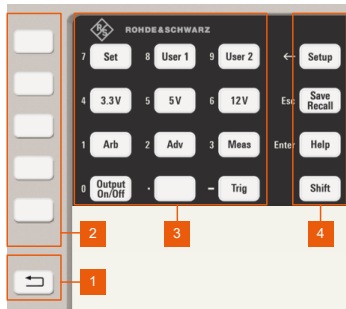
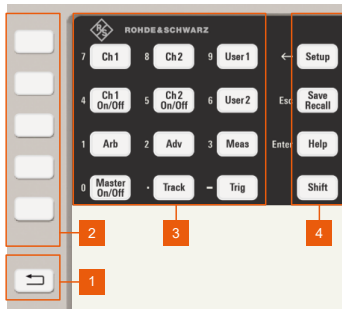
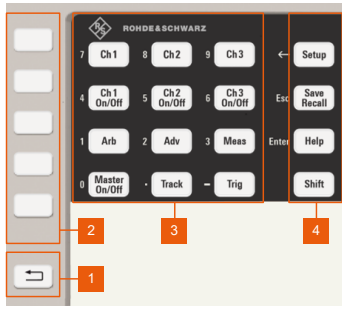
R&S NGC101(-G)	R&S NGC102(-G)	R&S NGC103(-G)
		
<ul style="list-style-type: none"> • 1 = Back key • 2 = Interactive softkeys • 3 = Measurement parameter keys • 4 = Utility keys 		

4.1.1.1 Back key

The  [Back] key is part of the navigation controls of the instrument.

[Back]

Provides functions to return to a previous level in menus or closes a view. It also allows you to abort an entry and the dialog closes without changing the settings.

4.1.1.2 Interactive softkeys

A set of five interactive softkeys providing the navigation controls in the menus.

[Interactive softkeys]

See details in ["Interactive softkeys \(2\)"](#) on page 28.

4.1.1.3 Measurement parameter keys

These keys provide access to the instrument settings and functions. Alternatively, these keys act as numeric keypad when [SHIFT] key is pressed. See [Figure 3-8](#).

[CH1] / [CH2] / [CH3]

Depending on the instrument models, up to three channels are provided for channel selections. These channel keys provide voltage and current settings for output channel and activation controls for arbitrary function, fuse control, OVP, OPP, ramp and analog input controls.

See [Chapter 3.3.1, "Selecting the channels"](#), on page 32 and [Chapter 5.1, "Voltage and current"](#), on page 53.

Remote command:

[INSTRument:NSElect](#) on page 140

[INSTRument\[:SElect\]](#) on page 141

Voltage ← [CH1] / [CH2] / [CH3]

Sets voltage values.

Remote command:

[\[SOURce:\]VOLTage\[:LEVel\]\[:IMMediate\]\[:AMPLitude\]](#)

[APPLY](#) on page 146

Current ← [CH1] / [CH2] / [CH3]

Sets current values.

Remote command:

[\[SOURce:\]CURRent\[:LEVel\]\[:IMMediate\]\[:AMPLitude\]](#)

[APPLY](#)

E.ARB ← [CH1] / [CH2] / [CH3]

Enables/Disables arbitrary function.

- "On": Arbitrary function is enabled.
- "Off": Arbitrary function is disabled.

Remote command:

[ARBitrary\[:STATe\]](#)

FUSE ← [CH1] / [CH2] / [CH3]

Enables/Disables fuse function.

- "On": Fuse function is enabled.
- "Off": Fuse function is disabled.

Remote command:

[FUSE\[:STATe\]](#)

OVP / OPP ← [CH1] / [CH2] / [CH3]

Enables/Disables OVP or OPP function.

- "On": OVP / OPP function is enabled.
- "Off": OVP / OPP function is disabled.

Remote command:

[SOURce:]VOLTage:PROTection[:STATe]

[SOURce:]POWer:PROTection[:STATe]

RAMP ← [CH1] / [CH2] / [CH3]

Enables/Disables EasyRamp function.

- "On": EasyRamp function is enabled.
- "Off": EasyRamp function is disabled.

Remote command:

[SOURce:]VOLTage:RAMP[:STATe]

ANALOG IN ← [CH1] / [CH2] / [CH3]

Enables/Disables Analog In function.

- "On": Analog In function is enabled.
- "Off": Analog In function is disabled.

Remote command:

[SOURce:]VOLTage:AINPut[:STATe]

[Set]

Available for R&S NGC101(-G) model only. This key provides similar functions as the channel key control. See "[CH1] / [CH2] / [CH3]" on page 47.

[3.3V] / [5V] / [12V]

Available for R&S NGC101(-G) model only. These keys provide pre-configured voltage setting of 3.3 V, 5 V and 12 V respectively.

Long pressed the key to set the preconfigured voltage to the channel output.

Remote command:

[SOURce:]VOLTage[:LEVel][:IMMediate][:AMPLitude]

APPLY on page 146

[User 1] / [User 2]

Available for R&S NGC101(-G) model only. These memory keys save and load user-defined settings of voltage and current value.

Long pressed the key to save the user settings. To load the user settings, press again on the same key.

[CH1 On/Off] / [CH2 On/Off] / [CH3 On/Off]

Depending on the instrument models, up to three channels are provided for channel activation. These channel keys activate the corresponding channel for output.

See also [Chapter 3.3.3, "Activating the channel output"](#), on page 34.

Remote command:

OUTPut:CHANnel[:STATe]

[Arb]

Provides activation and settings of EasyArb function which programs the waveform of the instrument with voltage and current values.

See [Chapter 5.10.1, "EasyArb"](#), on page 82.

[Adv]

Provides settings for advanced functions which include the EasyArb function, analog input, sequencing of channels, fuse control, trigger settings, OVP, OPP and EasyRamp functions.

See [Chapter 5.10.1, "EasyArb"](#), on page 82 and [Chapter 5.10.2, "EasyRamp"](#), on page 92.

See [Chapter 5.6, "Analog input"](#), on page 65.

See [Chapter 5.7, "Sequencing"](#), on page 68.

See [Chapter 5.3, "Electronic fuse"](#), on page 57.

See [Chapter 5.8, "External trigger"](#), on page 71.

See [Chapter 5.5, "Protection"](#), on page 62.

[Meas]

Provides activation and settings of energy meter, statistic display and logging functions.

See [Chapter 5.9, "Measurement functions"](#), on page 71.

[Master On/Off]

Provides controls of the channel output settings of the instrument. The master output switch turns on or off the channel output.

For R&S NGC101 model, the master output is the [Output On/Off] key.

See also [Chapter 3.3.3, "Activating the channel output"](#), on page 34 and [Chapter 5.2, "Channel output"](#), on page 55.

Remote command:

```
OUTPut:MASTer[:STATe]
```

[Track]

Available for R&S NGC102(-G) and R&S NGC103(-G) models. Tracking allows the simultaneous tracking of the voltage and current changes between tracked channels.

See [Chapter 5.4, "Tracking function"](#), on page 60.

[Trig]

Provides manual triggering control to activate function which has the triggered settings activated. (e.g. EasyArb, channel sequencing, data logging).

See [Chapter 5.7, "Sequencing"](#), on page 68, [Chapter 5.10.1, "EasyArb"](#), on page 82 and [Chapter 5.9.3, "Data logging"](#), on page 75.

See also [Chapter 5.8, "External trigger"](#), on page 71.

4.1.1.4 Utility keys

These keys provide utility settings for the following instrument functions.

[Setup]

Provides settings such as firmware updates, remote interface settings, general instrument configurations and factory default settings.

See [Chapter 7, "General instrument functions"](#), on page 100.

[Save Recall]

Provides saves and loads instrument settings and screenshot function.

See [Chapter 3.3.4, "Storing/Recalling of instrument settings"](#), on page 34 and [Chapter 6.1, "Save and recall"](#), on page 94.

[Help]

Provides integrated help topics on keys pressed or menu selected. Also acts as enter key function when pressed.

Long pressed [Help] key provides screenshot of the current display.

[Shift]

Activates the numeric keypad.

See ["Entering numeric parameters"](#) on page 43.

4.1.2 Navigation controls

Navigation and value settings are done via the rotary knob and arrow keys.

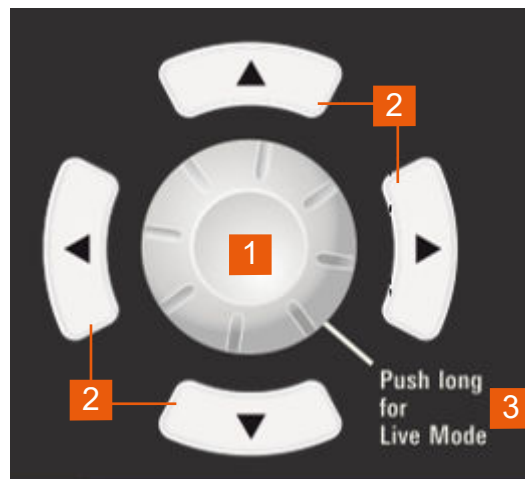

Figure 4-1: Navigation control

1 = Rotary knob

2 = Arrow keys

3 = Live-mode

For more information on how to navigate menus, dialogs and data entry in the instrument, see [Chapter 3.4.2.2, "Accessing the functionality"](#), on page 42 and [Chapter 3.4.2.3, "Entering data"](#), on page 43.

To go into live-mode of the instrument, see ["To go into live-mode"](#) on page 42.

4.2 Power derating

The degrading graph labeled on the frontpanel of R&S NGC101(-G) and R&S NGC102(-G) models show the derating curve of current quoted as a function of voltage at maximum output power schematically. For R&S NGC103(-G), see [Figure 4-2](#).

As specified, the R&S NGC100 provides high current and voltage ranges. For example, with R&S NGC103(-G), you can output up to 3 A and 32 V for each channel. However, if you set both parameters to maximum values, the resulting power would exceed the maximum 33 W output power per channel of the R&S NGC100. Therefore, the instrument automatically reduces the maximum current when the voltage increases above 11 V (in this example), to keep within the 33 W maximum output power per channel. This function protects the instrument from overload by decreasing the current as the voltage increases.

The following output performance graph for R&S NGC103(-G) shows the combination of the set voltage and current limit results.

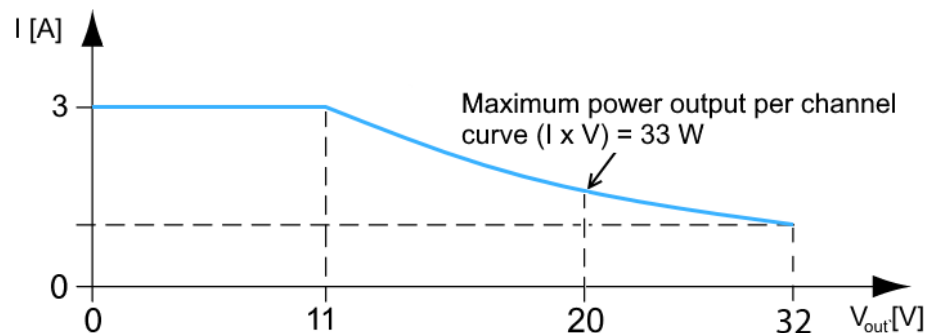

Figure 4-2: Output performance graph

According to the basic electrical formula for power (P) = current (I) x voltage (V), the following results for the maximum power per channel:

- R&S NGC101(-G): 100 W per channel
- R&S NGC102(-G): 50 W per channel (100 W max for the combination of two channels)
- R&S NGC103(-G): 33 W per channel (100 W max for the combination of three channels)

For more information on the combination of channels, see [Chapter 13.1, "Series mode"](#), on page 186 and [Chapter 13.2, "Parallel mode"](#), on page 187.

4.3 Operation modes

The R&S NGC100 operates in two different modes, i.e. CV and CC. The instrument switches automatically between CV and CC depending on the connected load.

CV mode

[Figure 4-3](#) shows that if the instrument is in the range of voltage regulation, the output voltage V_{out} remains constant while the current may increase to its maximum value I_{max} when the connected load is increasing. In CV mode, the font text in the channel display area changes to green.

See ["Operating modes"](#) on page 39.

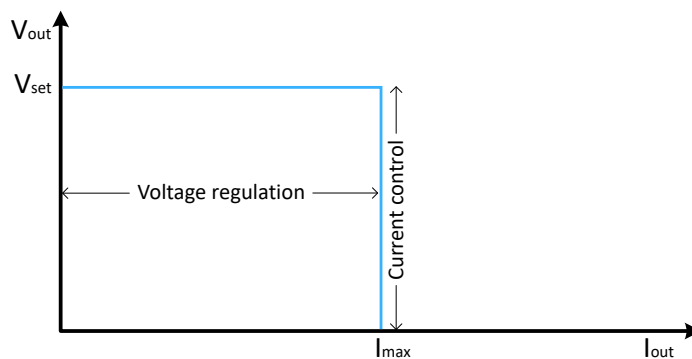

Figure 4-3: Current limit

CC mode

The current I_{max} corresponds to the current setting adjustable in the instrument.

If I_{out} reaches I_{max} , the instrument switches to CC mode, i.e. the output current remains constant and limited to I_{max} even if the load increases. Instead, the output voltage V_{out} decreases below V_{set} . In a short circuit, the output voltage drops towards zero. In CC mode, the font text in the channel display area changes to red.

See ["Operating modes"](#) on page 39.

5 Instrument functions

5.1 Voltage and current

The R&S NGC100 comes with the following instrument models:

Table 5-1: List of power supply models

Models	Channels
R&S NGC101-G	Ch 1,
R&S NGC102(-G)	Ch 1, Ch 2
R&S NGC103(-G)	Ch 1, Ch 2, Ch 3

Depending on the instrument models, press the respective channel key ([Ch 1], [Ch 2] or [Ch 3]) on the front panel to select these channels. When a channel is selected, the respective channel key illuminates. See [Figure 5-1](#).

For R&S NGC101(-G) model, press [Set] key on the front panel to set the voltage and current values.



Figure 5-1: Ch 1 key illuminates when selected



Conflict with arbitrary function

If "Arbitrary" function is enabled, the channel voltage or current setting is disabled.

The R&S NGC100 adjusts voltage values between 0 V to 35.0 V with a step size of 1 mV and current values step size of 0.1 mA ($1 < 1 \text{ A}$) / 1 mA ($1 \geq 1 \text{ A}$). For R&S NGC101(-G) model, the current values step size is 0.5 mA ($1 < 1 \text{ A}$) / 1 mA ($1 \geq 1 \text{ A}$). See [Table 5-2](#).

Table 5-2: Voltage, current step size

R&S NGC101(-G)	R&S NGC102(-G), R&S NGC103(-G)
1 mV	1 mV
1 < 1 A: 0.5 mA 1 ≥ 1 A: 1 mA	1 < 1 A: 0.1 mA 1 ≥ 1 A: 1 mA

The setting of current value corresponds to the I_{\max} of the respective channel. It is advisable to set the current limit before operating the instrument to prevent damage to the load and instrument in the case of malfunction like short-circuit.

Access:

- For R&S NGC102(-G) and R&S NGC103(-G) models, press the desired channel key (i.e. [Ch1]) on the front panel.
For R&S NGC101(-G) model, press [SET] key on the front panel.
The channel menu is displayed.
- Press the respective softkey to set the voltage or current limit setting of the selected channel. The value on the selected channel becomes editable and is highlighted in white.
All arrows keys on the navigation control are illuminated.

To configure voltage and current settings

- Enter the desired voltage or current value.
See [Chapter 3.4.2.3, "Entering data"](#), on page 43.
- Press the rotary knob or [HELP] key to confirm the value.
For more information on the operation modes, see [Chapter 4.3, "Operation modes"](#), on page 52.



Figure 5-2: Voltage and current settings in the instrument

See ["To go into live-mode"](#) on page 42 for alternative way to configure the voltage and current values.

See also ["FALLBACK"](#) on page 107 for setting the keypad fallback time.



In general, operating in multi-quadrant mode requires a multi-quadrant power supply. The R&S NGC100 is a one-quadrant power supply which is able to provide positive voltage or positive current. By connecting the positive terminal of "Ch 1" output to negative terminal of "Ch 2" output as reference ground, you can generate a range between -32 V and +32 V. This does not refer to a negative display on the screen, but rather to a connection with an identical voltage range. However, a negative current (current sink) is not possible.

See [Figure 5-3](#) for a connection example for R&S NGC103(-G), the connection for R&S NGC102(-G) is identical.

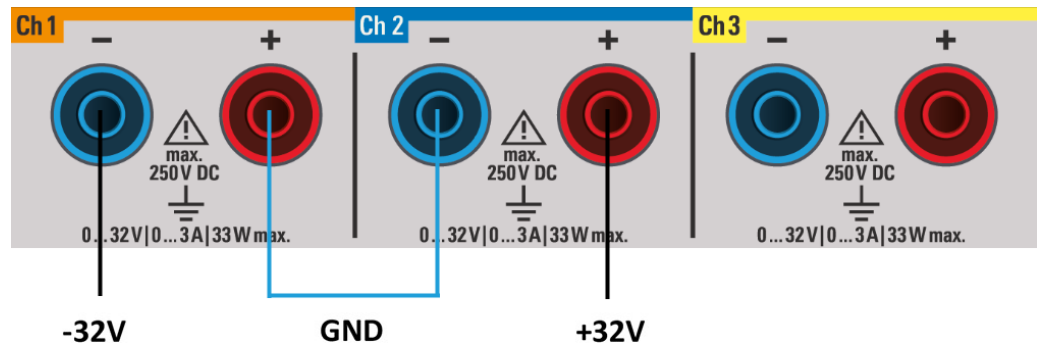

Figure 5-3: Setup to generate -32 V and +32 V

Settings

Voltage / Current..... 55

Voltage / Current

Sets output voltage or output current value.

See details in "Voltage" on page 47 and "Current" on page 47.

Remote command:

[SOURCE:]VOLTage[:LEVel] [:IMMediate] [:AMPLitude] on page 142

[SOURCE:]VOLTage[:LEVel] [:IMMediate] [:AMPLitude] {UP | DOWN} on page 143

[SOURCE:]VOLTage[:LEVel] [:INCRement] on page 143

[SOURCE:]CURRent[:LEVel] [:IMMediate] [:AMPLitude] on page 144

[SOURCE:]CURRent[:LEVel] [:IMMediate] [:AMPLitude] {UP | DOWN} on page 145

[SOURCE:]CURRent[:LEVel] [:INCRement] on page 145

APPLY on page 146

5.2 Channel output

Depending on the instrument models, the outputs of the channels (Ch 1, Ch 2, Ch 3) can be switched on or off by toggling the [Master On/Off] key on the front panel. For R&S NGC101 model, the output is switched on by the [Output On/Off] key.

By default, the output is turned off when the instrument is switched on.

Access:

- ▶ Press the required channel output key (e.g. [Ch 1 On/Off]).
Selected channel output key illuminates.

Activating channel output

- ▶ Press [Master On/Off] key.
For R&S NGC101(-G) model, the output is switched on by the [Output On/Off] key
The R&S NGC100 outputs the set voltage of the selected channel.
Depending on the operating modes, the font text in the channel display area shows green in CV mode and red in CC mode.
See [Chapter 4.3, "Operation modes"](#), on page 52.
See also [Chapter 4.2, "Power derating"](#), on page 51.

Multiple outputs can be turned on or off at the same time. See more information in [Chapter 13, "Applications"](#), on page 186.

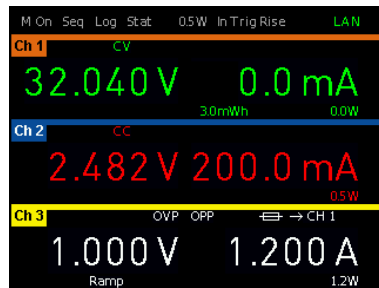

Figure 5-4: Output channels in different operating modes

Settings

[\[Master On/Off\] / \[Output On/Off\]](#)..... 56

[Master On/Off] / [Output On/Off]

Toggles to activate or deactivate the channel output.

See details in "[\[CH1\] / \[CH2\] / \[CH3\]](#)" on page 47 and "[\[Master On/Off\]](#)" on page 49.

Remote command:

[OUTPut:CHANnel \[: STATE\]](#) on page 147

[OUTPut:MASTer \[: STATE\]](#) on page 148

[OUTPut \[: STATE\]](#) on page 148

5.3 Electronic fuse



Fuse linking function is not available for R&S NGC101(-G) model.

To protect a connected, sensitive output in general, the R&S NGC100 power supply includes an electronic fuse which can be switched on individually for each channel.

A fuse delay can be applied to each channel and individual electronic fuses can be logically linked to switch off the interlinked channels if a fuse triggers.

For more information, see [Chapter 5.3.2, "Fuse delay, fuse linking"](#), on page 58 for fuse delay and fuse linking configuration.

5.3.1 Activating fuse

The following shows the steps to activate the electronic fuse in the instrument.

Access:

1. Turn off the output before activating the fuse for each channel.
2. Press [Adv] > "FUSE" to access the fuse menu.

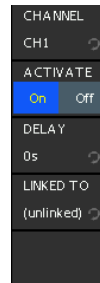

Figure 5-5: Fuse control menu

To activate fuse control

1. Set the "CHANNEL" to desire channel to active the fuse control.
2. Set the "ACTIVATE" to "On" to active the fuse control mode.
On the channel display area, the "FUSE",  indicator is displayed on activated channel.



Figure 5-6: Fuse indicator display at channel 1

- Set the "ACTIVATE" to "Off" to deactivate the fuse control mode.

Settings

CHANNEL.....	58
ACTIVATE.....	58

CHANNEL

Sets channel for fuse control.

Depending on instrument models, up to three channels are available for selection.

"CH1"/"CH2"/" CH3" Sets respective channel for fuse control.

Remote command:

See "[CH1] / [CH2] / [CH3]" on page 47

ACTIVATE

Toggles to activate or deactivate selected channel for fuse control.

"On" Fuse control is activated.

"Off" Fuse control is deactivated.

Remote command:

[FUSE\[:STATe\]](#) on page 151

[FUSE:TRIPed?](#) on page 151

5.3.2 Fuse delay, fuse linking

The fuse delay and fuse linking functions provide the flexibility to handle a fuse tripped event when it occurs. When the current for a channel exceeds the value I_{max} and the fuse tripped event triggered, the affected channels are turned off according to the settings configured in the fuse delay and fuse linking.

With fuse delay function, it allows you to ignore the current peaks set above the current limit that occurs during the time set in the fuse delay. This prevents the fuse to be triggered in case of a capacitive load.

With fuse linking function, it allows you to logically interlink channels with their electronic fuses. If a fuse trips during operation, all channels interlinked with this channel are turned off.

See [Chapter 5.3.1, "Activating fuse"](#), on page 57 for more information.

To configure fuse delay and fuse linking

Access:

1. Set [Adv] > "FUZE" > "Delay" softkey item to a desired value.
You can set a value from 0 s to 10 s in a 0.01 s step size.
2. Configure the [Adv] > "FUZE" > "LINKED TO" setting.
Depending on the instrument models, you can link up to two channels in the setting:

Example with reference to channel 1, the available options are as follows:

- "CH 2": "CH 2" is linked to "CH 1". If "CH 1" fuse tripped, "CH 2" is turned off.
- "CH 3": "CH 3" is linked to "CH 1". If "CH 1" fuse tripped, "CH 3" is turned off.
- "CH 2 & 3": "CH 2" and "CH 3" are linked to "CH 1". If "CH 1" fuse tripped, "CH 2" and "CH 3" are turned off.
- "(unlinked)": "CH 1" is not linked to any other channels.



Figure 5-7: Linking of channel 2 to channel 1

3. To deactivate the fuse control, repeat step 2 to step 4.
Alternatively, press the desired channel key (e.g. [Ch 1]) > "FUZE" to deactivate the fuse control.

Settings

DELAY.....	59
LINKED TO.....	59

DELAY

Time taken before fuse tripped event occurs.

The range of the fuse delay is 10 ms to 10 s.

Remote command:

FUZE:DELAY on page 150

LINKED TO

Sets the channel to interlink the fuse of the selected channel.

Depending on instrument models, the following options are available for linking.

"CH 1"/"CH 2"/"CH 3"	Respective channel is linked. It will be turned off if linking channel fuse tripped.
"CH 2 & 3"	Channel 2 and 3 are linked. It will be turned off if linking channel fuse tripped.
"CH 1 & 3"	Channel 1 and 3 are linked. It will be turned off if linking channel fuse tripped.
"(unlinked)"	No channel is linked.

Remote command:
[FUSE:LINK](#) on page 150
[FUSE:UNLink {1 | 2 | 3}](#) on page 151

5.4 Tracking function



Tracking function is not available for R&S NGC101(-G) model.

For power supplies with multiple channels, the channels can be linked such that changes made on the selected tracked channel are applied to other channels.

Example:

For R&S NGC103, the Ch 1 output supplies 6 V, intended for digital logic. The other two channels (Ch 2 & Ch 3) supply 20 V, which can be used with bipolar analog circuitry. The tracking adjustments are applied to the two 20 V supplies so that the ± 20 V supplies can be adjusted together.

Access:

1. Press [Track] key.
The R&S NGC100 activates the tracking function and the [Track] key illuminates.
2. Press the channel keys of the channels to be tracked.
The selected tracked channel key ([Ch 1] or [Ch 2] or [Ch 3]) illuminates.
Respective channel softkey menu is displayed.

Set the tracking function

1. Select "I" or "U" if current or voltage values should be tracked.
The selected channel keys are highlighted in white and all the navigation controls illuminate.
2. Set the desired voltage or current value.
Use the arrow keys or rotary knob to enter the value. All tracked channels voltage or current are changed by the same amount.

Once the setting has been completed, press the [TRACK] key again. Otherwise, the instrument will automatically switch back after 20 seconds, without the changes taking effect. See "FALLBACK" on page 107 chapter.

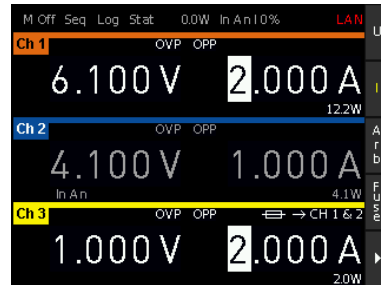

Figure 5-8: Tracking dialog

- Additional, the R&S NGC100 also provides tracked activation for "Arb", "Fuse", "OVP", "OPP", "Ramp" and "Ana" functions on the selected channels. If tracked, these functions are either activated or deactivated together. Note that "Arb", "Ramp" and "Ana" functions can only be activated exclusively.

Settings

U.....	61
I.....	61
Arb.....	61
Fuse.....	61
OVP / OPP.....	62
Ramp.....	62
Ana.....	62

U

Sets selected channels for voltage tracking.

Remote command:

n.a.

I

Sets selected channels for current tracking.

Remote command:

n.a.

Arb

Sets selected channels for EasyArb function tracking.

Remote command:

n.a.

Fuse

Sets selected channels for fuse function tracking.

Remote command:

n.a.

OVP / OPP

Sets selected channels for OVP / OPP function tracking.

Remote command:

n.a.

Ramp

Sets selected channels for EasyRamp function tracking.

Remote command:

n.a.

Ana

Sets selected channels for Analog In function tracking.

Remote command:

n.a.

5.5 Protection

The R&S NGC100 provides individual overvoltage protection (OVP) and overpower protection (OPP) settings for each channel. With both functions activated, the R&S NGC100 protects itself and the load in case of voltage or power overloads.

If protection is tripped, a red flashing OVP or OPP indicator is displayed on the respective channel. See [Figure 5-9](#).

A beep is sounded if buzzer is enabled. See [Figure 7-7](#).

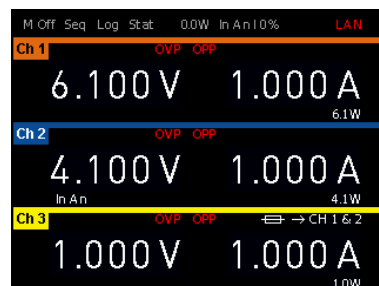

Figure 5-9: Indicator of OVP/OPP when tripped

Access:

1. Press [Adv] key.
2. Select "OVP" or "OPP" softkey item to configure the OVP/OPP protection menu. The R&S NGC100 displays the corresponding protection menu. See [Table 5-3](#).

Table 5-3: OVP and OPP protection menu

OVP menu	OPP menu
CHANNEL CH1	CHANNEL CH1
ACTIVATE On Off	ACTIVATE On Off
MODE Meas Prot	LEVEL 33.36W
LEVEL 32.050V	

Configure OVP or OPP settings

1. Set the "CHANNEL" softkey item to configure the protection menu for selected channel.
2. Set the desired "MODE" and "LEVEL" softkey items for OVP protection.
The R&S NGC100 turns off the output channel when the measured voltage exceeded the preset value.
3. Set the desired "LEVEL" softkey item for OPP protection.
The R&S NGC100 turns off the output channel when the measured power exceeded the preset value.
4. Set "ACTIVATE" to "On" to activate the respective protection mode.

Settings

OVP	63
L CHANNEL	63
L ACTIVATE	64
L MODE	64
L LEVEL	64
OPP	64
L CHANNEL	64
L ACTIVATE	64
L LEVEL	64

OVP

Configuration for OVP protection settings.

CHANNEL ← OVP

Depending on instrument models, up to three channels can be selected for OVP protection.

Remote command:

"[CH1] / [CH2] / [CH3]" on page 47

ACTIVATE ← OVP

Activates/deactivates the OVP protection.

"On" OVP is activated.

"Off" OVP is deactivated.

Remote command:

[\[SOURCE:\]VOLTage:PROTection\[:STATe\]](#) on page 155

[\[SOURCE:\]VOLTage:PROTection:TRIPped?](#) on page 155

[\[SOURCE:\]POWer:PROTection:CLEar](#) on page 156

MODE ← OVP

Sets OVP mode.

"Meas" If the measured value exceeds the set limit, the output is switched off. Switching on the channels triggered the OVP if the condition remains.

"Prot" If the setting exceeds the set limit, the output is disabled.

Remote command:

[\[SOURCE:\]VOLTage:PROTection:MODE](#) on page 154

LEVEL ← OVP

Sets OVP voltage level.

You can set a value from 0 V to 32.050 V.

The R&S NGC100 turns off the respective channel when the measured power exceeded the preset value.

Remote command:

[\[SOURCE:\]VOLTage:PROTection:LEVel](#) on page 154

OPP

Configuration for OPP protection settings.

CHANNEL ← OPP

Depending on instrument models, up to three channels can be selected for OPP protection.

Remote command:

["\[CH1\] / \[CH2\] / \[CH3\]"](#) on page 47

ACTIVATE ← OPP

Activates/deactivates the OVP protection.

"On" OPP is activated.

"Off" OPP is deactivated.

Remote command:

[\[SOURCE:\]POWer:PROTection\[:STATe\]](#) on page 157

[\[SOURCE:\]POWer:PROTection:TRIPped?](#) on page 157

[\[SOURCE:\]POWer:PROTection:CLEar](#) on page 156

LEVEL ← OPP

Sets OPP power level.

You can set a value from 0 W to 33.36 W.

The R&S NGC100 turns off the respective channel when the measured power exceeded the preset value.

Remote command:

[SOURce:]POWER:PROTection:LEVel on page 157

5.6 Analog input



Analog input

If "Analog In" of a selected channel (voltage or current) is enabled, the respective channel voltage or current setting is disabled.

The "Analog In" function cannot be used with sequencing, EASYRAMP and EASYARB simultaneously. It also cannot be used with the external trigger function as the same socket at the back panel is also used by the external trigger function. See [Figure 3-7](#).

See [Chapter 5.1, "Voltage and current"](#), on page 53.

See also ["Output terminals"](#) on page 31.

With "Analog In" function, you can regulate the channel output (voltage or current) settings with external control via voltage (0 V to 10 V) or current (4 mA to 20 mA). On the back panel of the instrument, you can find the connector for interface of the analog control signals, see [Figure 3-7](#).

Table 5-4: Analog input range

"Analog In" mode	R&S NGC101(-G) output	R&S NGC102(-G) output	R&S NGC103(-G) output
Voltage mode	0 V to 32 V	0 V to 32 V	0 V to 32 V
Current mode	0 A to 10 A	0 A to 5 A	0 A to 3 A

Access:

1. Press [Adv] key.
2. Select "ANALOG IN" softkey menu item
The R&S NGC100 displays the "ANALOG IN" menu.



Figure 5-10: Analog in menu

Configure Analog In settings

1. Select desired channel number to configure the "Analog In" channel settings.
2. Set "ACTIVATE" to "On" to enable the "Analog In" interface on selected channel.
3. Select the desired analog interface input.
4. Set the desired mode and threshold settings.

Example:

The following shows an example of linear operating mode which proportionally controls the voltage set at the front panel of the instrument. An external power supply unit is used as the source. The connection is established via plug-in terminal block connector which is connected with the external source. A voltage signal (U+/U-) is used in this example. See [Figure 3-7](#) and [Table 5-4](#).

Select a voltage of 5 V at the external source. Set the voltage value for Ch 1 to 1 V. If you activate the "Analog In" function for Ch 1, the voltage value for Ch 1 is set to 50 % of the previously selected voltage value. In this example, it would correspond to 500 mV.

If you increase the voltage for the external source to a maximum of 10 V, the voltage value for Ch 1 is set to 100 % of the previously selected voltage value. In this example, it would correspond to 1 V. Accordingly, if the output voltage for Ch 1 is controlled by means of a current signal. This procedure requires the current interface connectors (I+/I-). If you increase the current value for the external source to 20 mA, the voltage value for Ch 1 is set to 100 % of the previously selected voltage value. In this example, it would correspond to 1 V.

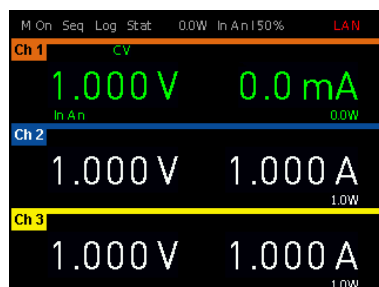

Figure 5-11: Analog In example for R&S NGC103(-G)

Settings

CHANNEL	67
ACTIVATE	67
INPUT	67
MODE	67
THRESHOLD	67

CHANNEL

Sets channel for "Analog In" function.

Depending on instrument models, up to three channels can be configured for "Analog In" function.

Remote command:

["\[CH1\] / \[CH2\] / \[CH3\]"](#) on page 47

ACTIVATE

Activates or deactivates the analog in function for the selected channel.

"On" "Analog In" function is activated.

"Off" "Analog In" function is deactivated.

Remote command:

[\[SOURCE:\]VOLTage:AINPut\[:STATe\]](#) on page 167

INPUT

Sets input interface for external control.

"U" Voltage interface is selected.

"I" Current interface is selected.

Remote command:

[\[SOURCE:\]VOLTage:AINPut:INPut](#) on page 166

MODE

Sets input mode for external control.

"Lin" Use the linear mode to proportionally control the voltage that is set at the front panel of the instrument.

"Step" If the threshold is exceeded, the "Step" setting issues the voltage of the selected output that is set at the front panel of the instrument. Otherwise 0 V is issued.

Remote command:

[\[SOURCE:\]VOLTage:AINPut:MODE](#) on page 166

THRESHOLD

Sets threshold input for external control from 0 V to 10 V, adjustable in step of 100 mV.

Only available if "Step" mode is selected.

Remote command:

[\[SOURCE:\]VOLTage:AINPut:THReshold](#) on page 167

5.7 Sequencing



Sequencing cannot be used with the arbitrary function simultaneously.

Sequencing enables you to run connected available channels consecutively with adjustable time offsets when the master output is switched on. It is also possible for all channels to be simultaneously switched on or off. The time offset between each channel can be adjusted between 1 ms to 10 s. The sequencing function is activated and deactivated individually for each channel. Additionally, the sequencing function can be activated by means of a manual trigger.

Access:

1. Press [Adv] key.
2. Select "SEQUENCE" softkey item to configure the sequencing settings.
The R&S NGC100 displays the sequencing menu. See [Figure 5-12](#).

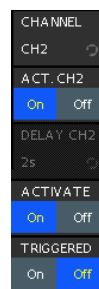

Figure 5-12: Sequencing menu

Configure sequencing settings

1. Select desired channel number to configure the sequencing channel settings.
2. Set the desired time offset for the selected channel.
3. Activate the sequencing delay for the selected channel (i.e. "ACT.CH1", "ACT.CH2", "ACT.CH3").
4. Activate the desired channels for sequencing function.
5. If manual trigger is required to start the sequencing function, set the "TRIGGERED" softkey item to "On".

Example:

The following shows the three methods, which how we can perform sequencing on the output channels.

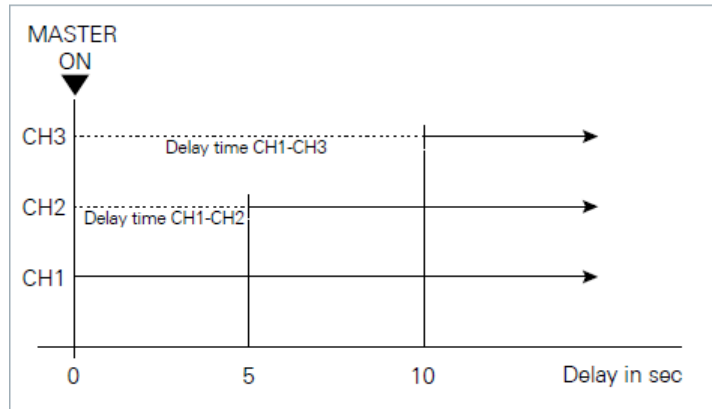

Figure 5-13: Example for R&S NGC103(-G) model sequencing

- **Start sequencing with master output on**
 - Set the respective time offset delay
 - Set corresponding channels in the sequencing menu ("ACT.CH1", "ACT.CH2", "ACT.CH3") to "On".
 - Activate the channels via softkey menu "ACTIVATE" for sequencing function.
 - Activate the channels via channel on/off key (i.e. [Ch 1 On/Off], [Ch 2 On/Off], [Ch 3 On/Off]).
 - Press the master output key (i.e. [Master On/Off]) to start the selected sequence.
- **Start sequencing via channel key**
 - Set the respective time offset delay
 - Set corresponding channel in the sequencing menu ("ACT.CH1", "ACT.CH2", "ACT.CH3") to "On".
 - Activate the channel via softkey menu "ACTIVATE" for sequencing function.
 - Deactivate the channels via channel on/off key (i.e. [Ch 1 On/Off], [Ch 2 On/Off], [Ch 3 On/Off]).
 - Press the master output key (i.e. [Master On/Off]) to start the selected sequence.
 - Press one of the channel keys included in the sequencing (i.e. [Ch 1 On/Off], [Ch 2 On/Off], [Ch 3 On/Off]).
- **Start sequencing via trigger**
 - Set the respective time offset delay
 - Set corresponding channel in the sequencing menu ("ACT.CH1", "ACT.CH2", "ACT.CH3") to "On".
 - Activate the channels via softkey menu "ACTIVATE" for sequencing function.
 - Activate the "TRIGGERED" softkey item to enable manual trigger of the sequencing.

- Deactivate the channels via channel on/off key (i.e. [Ch 1 On/Off], [Ch 2 On/Off], [Ch 3 On/Off]).
- Press the master output key (i.e. [Master On/Off]).
The [TRIG] key is blinking.
- Press [TRIG] key or one of the channel on/off keys included in the sequencing (i.e. [Ch 1 On/Off], [Ch 2 On/Off], [Ch 3 On/Off]) to start the sequence.

Settings

CHANNEL.....	70
ACT. <channel>.....	70
DELAY <channel>.....	70
ACTIVATE.....	70
TRIGGERED.....	70

CHANNEL

Sets channel for sequencing function.

Depending on instrument models, up to three channels can be configured for sequencing function.

Available for R&S NGC102 and R&S NGC103 models only.

Remote command:

"[CH1] / [CH2] / [CH3]" on page 47

ACT. <channel>

Activates or deactivates the sequencing delay for the selected channel.

"On" Sequencing delay is activated.

"Off" Sequencing delay is deactivated.

Remote command:

SEquence:CHANnel [:STATe] on page 168

DELAY <channel>

Time offset of the delay in duration from 1 millisecond to 60 seconds.

Remote command:

SEquence:DELay on page 168

ACTIVATE

Activates or deactivates the sequencing function for the selected channel.

"On" Sequencing function is activated.

"Off" Sequencing function is deactivated.

Remote command:

SEquence [:STATe] on page 169

TRIGGERED

Activates or deactivates the manual trigger for sequencing. If activated, press [TRIG] key to manually activate the trigger mode.

See also [Chapter 5.8, "External trigger"](#), on page 71.

"On" Manual trigger input is activated.
 "Off" Manual trigger input is deactivated.
 Remote command:
[SEquence:TRIGgered](#) on page 168

5.8 External trigger

You can input an external trigger signal (TTL input) to the voltage interface of the rear panel connector to start an arbitrary function, data logging and also to activate or deactivate sequencing.

For details of the voltage interface, see [Figure 3-7](#).

You can manage the external trigger signal either by the rising edge or falling edge.

Access:

1. Press [Adv] key.
2. Select "EXT.TRIG" softkey menu to set the triggering signal.
 A trigger signal is activated when the external trigger signal matches the [EXT.TRIG](#) setting.

Settings

[EXT. TRIG](#)..... 71

EXT. TRIG

Sets triggering signal.

"Rise" Triggering signal is activated when a rising edge is detected.

"Fall" Triggering signal is activated when a falling edge is detected.

Remote command:

[TRIGger:SLOPe](#) on page 139

5.9 Measurement functions

5.9.1 Statistics

The R&S NGC100 includes a statistic function which is able to determine statistic values (Min/Max, Mean, Count) for current and voltage for each channel.

See also "[Statistic function](#)" on page 39.

Access:

1. Press [Meas] key.
2. Select "STATS" softkey item to configure the statistic display of the instrument. Depending on the instrument models, the "STATS" menu is displayed differently.

Table 5-5: Statistic menu

R&S NGC101(-G)	R&S NGC102(-G)	R&S NGC103(-G)

To configure statistics settings

1. Turn on the "STATS" softkey item to display the statistics values in the screen display area.
Unlike R&S NGC101(-G) and R&S NGC102(-G) models, the R&S NGC103(-G) does not allow simultaneous display of the statistic channel values. It is run in the background and has to be accessed via [Meas] key. See also "[Statistic function](#)" on page 39.
2. Set "SHOW" softkey item to desired value to enable display of statistics values below the channel values.

Table 5-6: Statistic display

R&S NGC101(-G), statistic display turns on	R&S NGC101(-G), statistic display turns off

3. Select "Clear" softkey item to reset all statistic values.

Settings

STATS	73
SHOW	73
Clear	73

STATS

Activates or deactivates the statistics measurement.

"On" Statistics measurement is activated.

"Off" Statistics measurement is deactivated.

Remote command:

n.a.

SHOW

Enables or disables the display of statistic values.

"On" Statistics display is turned on.
For R&S NGC101(-G) model only.

"1"/"2" Statistics display is turned on for Ch 1 and Ch 2.
For R&S NGC102(-G) model only.

"Off" Statistics measurement is deactivated.

Remote command:

n.a.

Clear

Resets all statistic values.

Remote command:

n.a.

5.9.2 Energy meter

The "ENERGY" function enables you to show the energy release at the output in Ws.

Access:

1. Press [Meas] key.
2. Select "ENERGY" softkey item to configure the energy measurement of the instrument.
The R&S NGC100 displays the "ENERGY" menu.



Figure 5-14: Energy menu

To configure energy meter settings

1. Select desired channel number to configure the "ENERGY" channel settings.
2. Set "ACTIVATE" to "On" to enable the "ENERGY" measurement on selected channel.
3. Select "HOLD" to freeze current release energy values on the display. Select "HOLD" again to unfreeze the function.
4. Select "Clear" to reset the energy values.

Settings

CHANNEL.....	74
ACTIVATE.....	74
HOLD.....	74
Clear.....	75

CHANNEL

Sets channel for "ENERGY" measurement settings.

Depending on instrument models, up to three channels can be configured for "ENERGY" measurement settings.

Remote command:

"[CH1] / [CH2] / [CH3]" on page 47

ACTIVATE

Activates or deactivates the "ENERGY" function for the selected channel.

"On" "ENERGY" function is activated.

"Off" "ENERGY" function is deactivated.

Remote command:

MEASure [:SCALar] :ENERgy:STATe on page 158

HOLD

Freezes/Unfreezes current released energy values in the display.

Remote command:

MEASure [:SCALar] :ENERgy? on page 158

MEASure [:SCALar] :VOLTage [:DC]? on page 159

[MEASure\[:SCALar\]:CURRent\[:DC\]? on page 158](#)

[MEASure\[:SCALar\]:POWER\[:DC\]? on page 159](#)

Clear

Resets energy measurement values.

Remote command:

[MEASure\[:SCALar\]:ENERgy:RESet on page 159](#)

5.9.3 Data logging



External USB hard disc drives (or USB extension) not supportable. Only FAT/FAT32 formatted USB sticks can be used.

The data logging function provides the logging of data (measurement values) to internal memory of the R&S NGC100 or externally connected memory device, e.g. USB flash drive. The following shows a sample of a log file captured from R&S NGC103(-G).

```
#Device;R&S®NGC103
#Device Name;Device under test HM
#Format;LOG
#Date;2022 - 01 - 01
#Version;00.014-02.301-03.651
#Serial No.;NO SERIAL NUMBER

#Mode;Unlimited
#Logging Interval[s];1.000
#Specified Logging Count;-----
#Specified Logging Time[s];-----
#Sequence;Off

#CH1 Voltage Target[V];25.050
#CH1 Current Target[A];0.130
#CH1 Sequence Delay[s];-----
#CH1 EasyArb;Off
#CH1 OVP;Off
#CH1 OPP;Off
#CH1 Ramp;Off
#CH1 Analog in;Off

#CH2 Voltage Target[V];16.000
```

Figure 5-15: Log file sample

Access:

1. Press [Meas] key.
2. Select "LOGGING" softkey item to configure data logging function.
The R&S NGC100 displays the "LOGGING" menu.

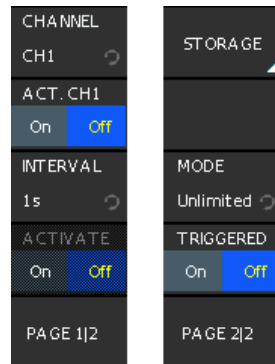

Figure 5-16: Data logging menu

To configure data logging settings

1. Select "CHANNEL" to set desired channel number to configure the "LOGGING" channel settings.
2. Select "INTERVAL" to set the desired measurement interval to capture measurement records.
3. Select "PAGE 1|2" > "STORAGE" to set the desired storage location, filename and file format for the data logger. See "STORAGE" on page 78 and "FILENAME" on page 80.
4. Select the desired data logging mode to capture measurements. See "MODE" on page 82.
5. Set "ACTIVATE" to "On" to start the capture and storage of measurement records on selected channel.

6. If manual trigger is required to start the data logging function, set the "TRIGGERED" softkey item to "On".

Remote commands:

[DATA:DATA?](#) on page 174

[DATA:LIST?](#) on page 175

[DATA:POINTs?](#) on page 175

7. To stop data logging, set "ACTIVATE" to "Off".
Alternatively, data logging stops when time span or the number of counts elapsed.

Settings

CHANNEL.....	77
ACT. <channel>.....	77
INTERVAL.....	78
ACTIVATE.....	78
Page 1 2 / Page 2 2.....	78
STORAGE.....	78
L STORAGE.....	78
L Change directory.....	79
L Create directory.....	79
L Backspace.....	79
L CLEAR ALL.....	79
L CURSOR <-.....	79
L CURSOR ->.....	79
L ACCEPT.....	79
L Remove directory.....	79
L ACCEPT.....	79
L FILENAME.....	80
L Backspace.....	80
L DEFAULT.....	80
L CURSOR <-.....	80
L CURSOR ->.....	80
L ACCEPT.....	80
L FORMAT.....	80
L BROWSER.....	80
L STORAGE.....	81
L Change directory.....	81
L Delete file.....	81
L Remove directory.....	81
L Delete file.....	81
L ACCEPT.....	81
TIME.....	81
COUNT.....	82
MODE.....	82
TRIGGERED.....	82

CHANNEL

Sets channel for data logging settings.

Depending on instrument models, up to three channels can be configured for data logging.

Remote command:

"[CH1] / [CH2] / [CH3]" on page 47

ACT. <channel>

Enables or disables the data logging function on selected channel.

"On" Data logging is enabled.

"Off" Data logging is disabled.

Remote command:

[DATA:] LOG[:STATe] on page 173

INTERVAL

Sets measurement interval for data logging. The measurement interval describes the time between the recorded measurements.

Remote command:

[DATA:] LOG:INTerval on page 172

ACTIVATE

Starts or stops the data logging for the selected channel.

"On" Data logging is activated and the R&S NGC100 starts capturing the data.

"Off" Data logging is deactivated and the R&S NGC100 stops capturing the data.

Remote command:

[DATA:] LOG:CHANnel[:STATe] on page 171

Page 1|2 / Page 2|2

Toggles between the pages of the "Logging" softkey menu.

Remote command:

n.a.

STORAGE

Configures storage settings.



Figure 5-17: Storage menu

STORAGE ← STORAGE

Opens file manager dialog of selected memory location to set target directory.

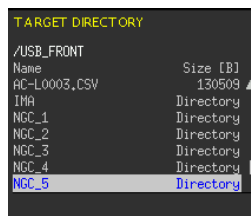

Figure 5-18: Selected target directory (USB_FRONT) for storage

"Int." Internal memory location.

"Front" USB stick location.

Remote command:

n.a.

Change directory ← STORAGE ← STORAGE

Changes directory path in the USB stick location.

Remote command:

n.a.

Create directory ← STORAGE ← STORAGE

Opens on-screen keypad to create a directory path in the USB stick location.

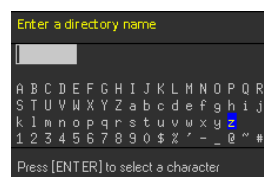

Figure 5-19: On-screen keypad to create directory

Remote command:

n.a.

Backspace ← Create directory ← STORAGE ← STORAGE

See "[Backspace](#)" on page 80.

CLEAR ALL ← Create directory ← STORAGE ← STORAGE

Clear all entries in the input field.

CURSOR <- ← CLEAR ALL ← Create directory ← STORAGE ← STORAGE

See "[CURSOR <-](#)" on page 80.

CURSOR -> ← CLEAR ALL ← Create directory ← STORAGE ← STORAGE

See "[CURSOR ->](#)" on page 80.

ACCEPT ← CLEAR ALL ← Create directory ← STORAGE ← STORAGE

See "[ACCEPT](#)" on page 80.

Remove directory ← STORAGE ← STORAGE

Removes selected directory in the USB stick location.

Remote command:

n.a.

ACCEPT ← STORAGE ← STORAGE

Confirms entry for settings.

Remote command:

n.a.

FILENAME ← STORAGE

Opens the on-screen keypad to set filename of the saved data logged file.

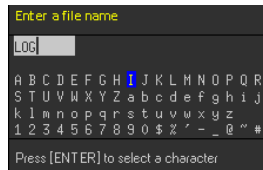

Figure 5-20: On-screen keypad for filename entry

Remote command:

[DATA:] LOG:FNAME on page 171

Backspace ← FILENAME ← STORAGE

Deletes entry to the left of the cursor position.

DEFAULT ← FILENAME ← STORAGE

Sets to default naming convention for data log file, i.e. LOGxxxx where "xxxx" refers to the incremental index starting from "0001".

Remote command:

n.a.

CURSOR <- ← FILENAME ← STORAGE

Left arrow to navigate the cursor position in the field entry.

Remote command:

n.a.

CURSOR -> ← FILENAME ← STORAGE

Right arrow to navigate the cursor position in the field entry.

Remote command:

n.a.

ACCEPT ← FILENAME ← STORAGE

Confirms entry for input field.

Remote command:

n.a.

FORMAT ← STORAGE

Sets data logging format.

"CSV" Comma-separated values text file.

"TXT" Standard text document that contains plain text.

Remote command:

[DATA:] LOG:FORMat on page 172

BROWSER ← STORAGE

Opens file manager dialog of selected memory location to set source file for data logging.

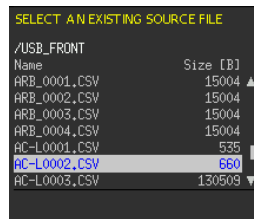

Figure 5-21: Select source filename for data logging

STORAGE ← BROWSER ← STORAGE

Sets storage location for browsing data logging file.

"Int." Internal memory location.

"Front" USB stick location.

Remote command:

n.a.

Change directory ← STORAGE ← BROWSER ← STORAGE

Changes directory path in the USB stick location.

Remote command:

n.a.

Delete file ← STORAGE ← BROWSER ← STORAGE

Deletes selected file.

Remote command:

n.a.

Remove directory ← STORAGE ← BROWSER ← STORAGE

Removes selected directory in the USB stick location.

Remote command:

n.a.

Delete file ← BROWSER ← STORAGE

Deletes selected file.

Remote command:

[DATA:DELeTe](#) on page 174

ACCEPT ← BROWSER ← STORAGE

Confirms the settings.

Remote command:

n.a.

TIME

Duration of the measurement values capture.

See also "[MODE](#)" on page 82.

Remote command:

[\[DATA:\] LOG:TIME](#) on page 173

COUNT

Number of measurement values to be captured.

See also "MODE" on page 82.

Remote command:

[DATA:] LOG:COUNT on page 171

MODE

Sets data capturing mode.

"Unlimited" Infinite data capture. The limiting factor in this context is the size of the internal storage (512 kB max.) or of the connected USB stick (4 GB max., FAT/FAT32 formatted).

"Count" Number of measurement values to be captured. See "COUNT" on page 82.

"Time" Duration of the measurement values capture. See "TIME" on page 81.

Remote command:

[DATA:] LOG:MODE on page 172

TRIGGERED

Activates or deactivates the manual trigger for data logging. If activated, press [TRIG] key to manually activate the trigger mode.

See "[Trig]" on page 49.

"On" Manual trigger input is activated.

"Off" Manual trigger input is deactivated.

Remote command:

[DATA:] LOG:TRIGgered on page 173

5.10 Advanced functions

The following chapters provide information about the [EasyArb](#) and [EasyRamp](#) menu items found in the [Adv] key.

5.10.1 EasyArb



LabVIEW driver

The arbitrary functions in LabVIEW driver rshmc804x do not support the EasyArb feature in the R&S NGC100.



The arbitrary functions cannot be used together with the sequencing simultaneously.

The R&S NGC100 series allows you to generate freely programmable waveforms which can be reproduced within the limits set by the instrument for voltage and current of the respective channel. To configure a waveform, you can use the control panel or an externally created waveform, see "[Using R&S HME Explorer software to create arbitrary waveform](#)" on page 85.

Each channel has its own arbitrary memory which means that when an arbitrary waveform is generated and that the arbitrary waveform of the respective channel is then started. Depending on the instrument models, up to three arbitrary waveform can be generated. If arbitrary waveform is disabled, the respective channel is also disabled.

Access:

1. Press [Adv] key.
2. Select "EASY ARB" to configure the EasyArb menu.
Alternatively, press the shortcut key [Arb] to access the EasyArb menu.
The R&S NGC100 displays the EasyArb menu.

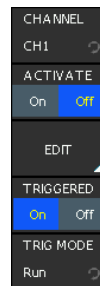

Figure 5-22: EasyArb menu

To configure EasyArb settings

1. Select desired channel number to configure the arbitrary channel settings.
2. Set "ACTIVATE" to "On" to enable the EasyArb function on selected channel.
3. If generation of the arbitrary function needs to be manually triggered, set the "TRIGGERED" to "On".
4. Select the desired triggered mode.
5. Select "EDIT" to edit the arbitrary dialog on the selected channel.
For details on how to configure the arbitrary dialog, see "[Edit EasyArb dialog](#)" on page 84.
6. To output the arbitrary waveform, press the respective channel on/off key (e.g. [Ch 1 On/Off], [Ch 2 On/Off] or [Ch 3 On/Off]) and master output key.
The arbitrary waveform is generated at the output.

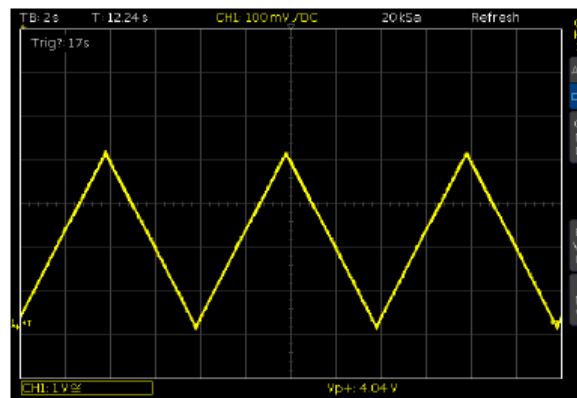

Figure 5-23: Arbitrary waveform example

Edit EasyArb dialog

The arbitrary dialog provides the sequence of voltage and current settings with time-stamp per point to generate the waveform. Interpolation setting at the last column provides the option to interpolate the generated points.

EasyArb Editor CH2					CHANNEL
Idx	U	I	Time	Intp	CH2
001	05.000	01.0000	005.00	N	CH2
002	10.000	01.0000	005.00	N	
003	05.000	01.0000	005.00	N	
004	20.000	01.0000	005.00	N	
005	05.000	01.0000	000.01	Y	
006	00.000	01.0000	000.01	Y	
007	00.000	01.0000	000.01	Y	
008	00.000	01.0000	000.01	Y	
					IDX
					5
					REPETITION
					0
					ENDPOINT
					8
					PAGE 1/2

Figure 5-24: Arbitrary dialog

- To navigate in the dialog, see ["To select a parameter in a dialog"](#) on page 42. You can set the "IDX" to go to the required row number for configuration.
- Select "REPETITION" to set the desired repetition rate. A maximum of 256 repetition rate is possible. If repetition rate is set to "0", the arbitrary function is repeated infinitely until the waveform is disabled via the "ACTIVATE" softkey set to "Off"
- To add more rows, set the "ENDPOINT" to a desired number. A possibility of up to 512 arbitrary points can be generated.
- Set "PAGE 1/2" > "END BEHAV." to define the arbitrary endpoint behavior.
- Select "PAGE 1/2" > "SAVE/LOAD" to save or load arbitrary data internally or externally on a USB stick which can be reloaded via "LOAD" softkey item. See ["SAVE/LOAD"](#) on page 87 and ["LOAD"](#) on page 90.
- To copy arbitrary data from one channel to another, select "PAGE 1/2" > "COPY" to copy data to a desired channel.
- Select "PAGE 1/2" > "Clear All" to reset the arbitrary dialog.

Using R&S HMEplorer software to create arbitrary waveform

Alternatively, you can also use HMEplorer software to create arbitrary waveform. The software allows you to create each point of a waveform by use of the editor. You can add or delete individual points by using the "+" or "-" function. With the function "INTERPOLATION", the defined arbitrary points can be output interpolated.

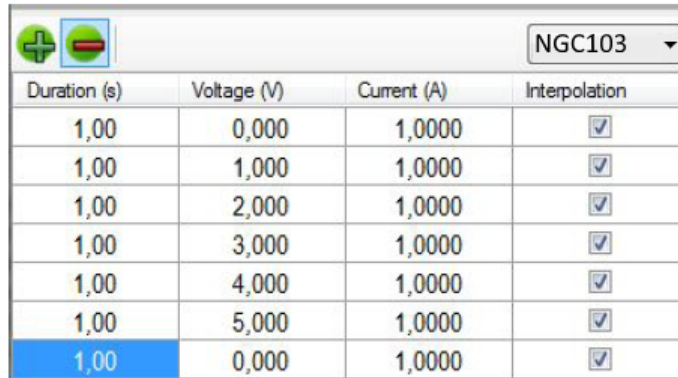

Duration (s)	Voltage (V)	Current (A)	Interpolation
1,00	0,000	1,0000	<input checked="" type="checkbox"/>
1,00	1,000	1,0000	<input checked="" type="checkbox"/>
1,00	2,000	1,0000	<input checked="" type="checkbox"/>
1,00	3,000	1,0000	<input checked="" type="checkbox"/>
1,00	4,000	1,0000	<input checked="" type="checkbox"/>
1,00	5,000	1,0000	<input checked="" type="checkbox"/>
1,00	0,000	1,0000	<input checked="" type="checkbox"/>

Figure 5-25: Arbitrary-editor example (excerpt) R&S HMEplorer software

Once all arbitrary points have been created, the created signal can be transferred to the instrument via interface by using the menu item "TRANSFER". The menu "TRANSFER" opens and allows you to select the respective R&S NGC100 channel and the repetitions. Additionally, you can also activate the output to issue the signal directly at the output and to view it on an oscilloscope.

For details on how to setup R&S HMEplorer, see R&S HMEplorer software user manual.

Settings

CHANNEL.....	86
ACTIVATE.....	86
EDIT.....	86
L CHANNEL.....	86
L IDX.....	87
L REPETITION.....	87
L END POINT.....	87
L Page 1 2 / Page 2 2.....	87
L END BEHAV.....	87
L SAVE/LOAD.....	87
L SAVE.....	88
L STORAGE.....	88
L Change directory.....	88
L Create directory.....	88
L Remove directory.....	88
L ACCEPT.....	88
L FILENAME.....	89
L Backspace.....	89
L DEFAULT.....	89
L CURSOR <-.....	89

L CURSOR ->.....	89
L ACCEPT.....	89
L COMMENT.....	89
L Backspace.....	89
L CLEAR ALL.....	89
L CURSOR <-.....	89
L CURSOR ->.....	90
L ACCEPT.....	90
L SAVE.....	90
L LOAD.....	90
L STORAGE.....	90
L Change directory.....	90
L Delete file.....	90
L Remove directory.....	91
L ACCEPT.....	91
L COPY.....	91
L Clear All.....	91
TRIGGERED.....	91
TRIG MODE.....	91

CHANNEL

Sets channel for arbitrary function.

Depending on instrument models, up to three channels can be configured for arbitrary function.

Available for R&S NGC102 and R&S NGC103 models only.

Remote command:

"[CH1] / [CH2] / [CH3]" on page 47

ACTIVATE

Activates or deactivates the arbitrary function for the selected channel.

"On" Arbitrary function is activated.

"Off" Arbitrary function is deactivated.

Remote command:

ARBitrary[:STATe] on page 164

EDIT

Edits arbitrary table.

CHANNEL ← EDIT

Sets channel for arbitrary table.

Depending on instrument models, up to three channels can be configured for the arbitrary table.

Available for R&S NGC102 and R&S NGC103 models only.

Remote command:

"[CH1] / [CH2] / [CH3]" on page 47

IDX ← EDIT

Sets row index in the arbitrary table for configuration.

Remote command:

n.a.

REPETITION ← EDIT

Sets repetition rate for arbitrary functionality.

Up to 255 repetitions are possible. If the repetition rate "0" is selected, the arbitrary waveform of the selected channel is repeated infinitely.

Remote command:

[ARbitrary:REPetitions](#) on page 162

END POINT ← EDIT

Sets arbitrary waveform endpoint of selected channel.

A possibility of up to 512 arbitrary points can be generated.

Remote command:

[ARbitrary:ENDPoint](#) on page 161

Page 1|2 / Page 2|2 ← EDIT

Toggles between the pages of the "Edit" softkey menu.

Remote command:

n.a.

END BEHAV. ← EDIT

Sets arbitrary endpoint behavior when arbitrary function is finished.

- "OFF":
- "HOLD": In "HOLD" mode the last defined arbitrary point is held. If the arbitrary function is finished, the respective instrument channel is not disabled.

"OFF" Default setting.

In "OFF" mode, the instrument deactivates the respective channel automatically, if the ARB function is finished.

"HOLD" In "HOLD" mode, the last defined arbitrary point is held. If the arbitrary function is finished, the respective instrument channel is not disabled.

Remote command:

[ARbitrary:BEHavior:END](#) on page 161

SAVE/LOAD ← EDIT

Saving and loading of arbitrary data.

See below a data format example for an arbitrary file:

Example:

```
#Device;R&S@HMC8043
#Device Name;ABC
#Format;ARB
#Date;2014-09-03
#Rep;0
#EP;4
#Version;01.003-02.401-03.701
#Serial No.;020600484
Idx;U;I;Time;Interp
001;10.500;00.4000;001.00;0
002;13.000;00.4000;001.00;0
003;09.500;00.4000;001.00;0
004;11.000;00.4000;001.00;0
```

SAVE ← SAVE/LOAD ← EDIT

Saves arbitrary data.

Remote command:

[ARbitrary:SAVE](#) on page 162

[ARbitrary:DATA](#) on page 164

STORAGE ← SAVE ← SAVE/LOAD ← EDIT

Sets storage location for saving arbitrary file.

"Int." Internal memory location.

"Front" USB stick location.

Remote command:

n.a.

Change directory ← STORAGE ← SAVE ← SAVE/LOAD ← EDIT

Changes directory path in the USB stick location.

Remote command:

n.a.

Create directory ← STORAGE ← SAVE ← SAVE/LOAD ← EDIT

Creates a directory path in the USB stick location.

Remote command:

n.a.

Remove directory ← STORAGE ← SAVE ← SAVE/LOAD ← EDIT

Removes selected directory in the USB stick location.

Remote command:

n.a.

ACCEPT ← STORAGE ← SAVE ← SAVE/LOAD ← EDIT

Confirms the settings.

Remote command:

n.a.

FILENAME ← SAVE ← SAVE/LOAD ← EDIT

Filename of the saved arbitrary file.

The on-screen keypad is displayed for entry.

Remote command:

ARbitrary:FNAME on page 162

Backspace ← FILENAME ← SAVE ← SAVE/LOAD ← EDIT

Deletes entry to the left of the cursor position.

Remote command:

n.a.

DEFAULT ← FILENAME ← SAVE ← SAVE/LOAD ← EDIT

Sets to default naming convention for arbitrary filename, i.e. ARBxxxx where "xxxx" refers to the incremental index starting from "0001".

Remote command:

n.a.

CURSOR <- ← FILENAME ← SAVE ← SAVE/LOAD ← EDIT

Left arrow to navigate the cursor position in the filename field entry.

Remote command:

n.a.

CURSOR -> ← FILENAME ← SAVE ← SAVE/LOAD ← EDIT

Right arrow to navigate the cursor position in the filename field entry.

Remote command:

n.a.

ACCEPT ← FILENAME ← SAVE ← SAVE/LOAD ← EDIT

Confirms entry for filename

Remote command:

n.a.

COMMENT ← SAVE ← SAVE/LOAD ← EDIT

Comments on the saved arbitrary file.

Remote command:

n.a.

Backspace ← COMMENT ← SAVE ← SAVE/LOAD ← EDIT

Deletes entry to the left of the cursor position.

CLEAR ALL ← COMMENT ← SAVE ← SAVE/LOAD ← EDIT

Clears all entry in the comment field entry.

CURSOR <- ← COMMENT ← SAVE ← SAVE/LOAD ← EDIT

Left arrow to navigate the cursor position in the filename field entry.

CURSOR -> ← COMMENT ← SAVE ← SAVE/LOAD ← EDIT

Right arrow to navigate the cursor position in the filename field entry.

ACCEPT ← COMMENT ← SAVE ← SAVE/LOAD ← EDIT

Confirms entry for comment.

SAVE ← SAVE ← SAVE/LOAD ← EDIT

Saves current arbitrary table data.

Remote command:

[ARbitrary:SAVE](#) on page 162

LOAD ← SAVE/LOAD ← EDIT

Loads arbitrary data.

The file manager dialog is displayed.

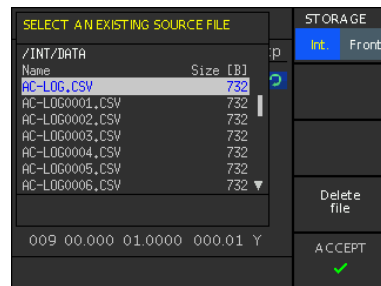

Figure 5-26: File manager dialog

Remote command:

[ARbitrary:LOAD](#) on page 162

[ARbitrary:DATA](#) on page 164

STORAGE ← LOAD ← SAVE/LOAD ← EDIT

Sets storage location for loading arbitrary file.

"Int." Internal memory location.

"Front" USB stick location.

Remote command:

n.a.

Change directory ← LOAD ← SAVE/LOAD ← EDIT

Changes directory path in the USB stick location.

Remote command:

n.a.

Delete file ← LOAD ← SAVE/LOAD ← EDIT

Deletes selected file in the selected memory location.

Remote command:

n.a.

Remove directory ← LOAD ← SAVE/LOAD ← EDIT

Removes selected directory in the USB stick location.

Remote command:

n.a.

ACCEPT ← LOAD ← SAVE/LOAD ← EDIT

Confirms the settings.

Remote command:

n.a.

COPY ← EDIT

Depending on selected channel and instrument model used. You have the option to copy arbitrary data from one channel to the other channel.

Available for R&S NGC102 and R&S NGC103 models only.

"Copy to CH 1" / "Copy to CH 2" / "Copy to CH 3" Copies existing entries from selected channel to the respective channel.

Remote command:

n.a.

Clear All ← EDIT

Resets all entries in the arbitrary table.

A popup message "data table clear successfully" is displayed.

Remote command:

[ARbitrary:CLEar](#) on page 161

TRIGGERED

Activates or deactivates the manual trigger for arbitrary functionality. If activated, press [TRIG] key to manually activate the trigger mode.

See "[Trig]" on page 49.

"On" Manual trigger input is activated.

"Off" Manual trigger input is deactivated.

Remote command:

[ARbitrary:TRIGgered\[:STATe\]](#) on page 163

TRIG MODE

Sets manual trigger mode.

"Single" By pushing the [TRIG] key, each single arbitrary point is generated at the output one after another.

"Run" By pushing the [TRIG] key the whole arbitrary waveform is generated at the output.

Remote command:

[ARbitrary:TRIGgered:MODE](#) on page 163

5.10.2 EasyRamp



EasyRamp cannot be used with Analog In and arbitrary function simultaneously.

With EasyRamp, the R&S NGC100 provides you with the operating condition to output a constant rise of the supply voltage. The output voltage can be increased continuously within a 10 ms to 10 s timeframe. See [Figure 5-27](#).

Depending on the instrument models, up to three ramp settings can be generated.

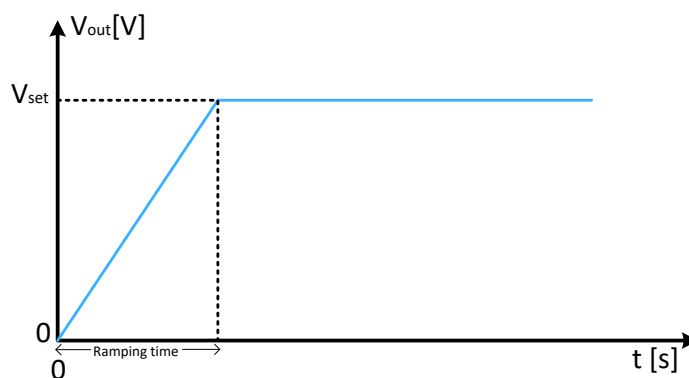

Figure 5-27: Ramping voltage output

Access:

1. Press [Adv] key.
2. Select "RAMP" softkey item to configure the ramp menu.
The R&S NGC100 displays the ramp menu. See [Figure 5-28](#).

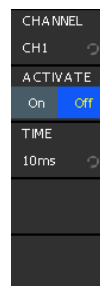

Figure 5-28: Ramp menu

To configure ramping output

1. Select desired channel number to configure the ramp settings.

2. Set "ACTIVATE" to "On" to enable the ramp function on selected channel.
3. Set the desired time for ramping duration.

The R&S NGC100 outputs a constant rise of supply voltage within the ramp duration.

Settings

CHANNEL.....	93
ACTIVATE.....	93
TIME.....	93

CHANNEL

Sets channel for ramp function.

Depending on instrument model, up to three channels can be configured for ramp function.

Available for R&S NGC102 and R&S NGC103 models only.

Remote command:

"[CH1] / [CH2] / [CH3]" on page 47

ACTIVATE

Activates or deactivates the ramp function for the selected channel.

- "On": Ramp function is activated.
- "Off": Ramp function is deactivated.

Remote command:

[SOURCE:]VOLTage:RAMP[:STATe] on page 165

TIME

Duration taken for the ramping.

Remote command:

[SOURCE:]VOLTage:RAMP:DURation on page 165

6 File and data management

The R&S NGC100 enables you to save instrument configurations, settings and screenshots of the current screen. Depending on the type of data, you can use the internal memory, or save data to an external USB memory device.

Type of data files

Data files include measurement configurations and records, screenshots and instrument settings.

Depending on the content, user data is roughly categorized in the following data types:

- *Settings*: instrument settings of a measurement configuration saved and recalled for later reuse, see [Chapter 3.3.4, "Storing/Recalling of instrument settings"](#), on page 34.
- *Measurement readings*: recorded measurement results saved for evaluation, see [Chapter 5.9.3, "Data logging"](#), on page 75.
- *Screenshots*: screen captures of settings or measurement mode windows, see [Chapter 6.2, "Screenshot"](#), on page 97.

File memory location

The R&S NGC100 saves user files on the internal memory or, if connected, on a USB memory stick, but screenshots only on an external USB. With the "File Manager" functions, you can exchange files between the internal and an external memory, provided you have connected a USB memory stick.

The memory locations on the internal memory are predefined, on an external USB stick, you can create, define or delete directories as known from common file explorers.

6.1 Save and recall

With the "Save/Recall" functions, you can save a certain instrument configuration in a file and reload it for later reuse.

Access:

- ▶ Press [Save Recall] > "Device Settings" to save and load previously saved instrument settings.

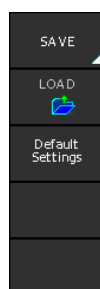

Figure 6-1: Save recall softkey menu

To save instrument settings

1. To save instrument settings, select "SAVE" softkey item.
The R&S NGC100 displays the save menu.



Figure 6-2: Save menu

2. Set the desired storage location, filename and comment.
3. Select "SAVE" softkey item to save the instrument settings to the selected location.

To recall / delete instrument settings

1. To recall previously saved instrument settings, select "LOAD" softkey item.
The R&S NGC100 displays the load menu.

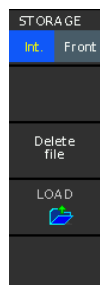

Figure 6-3: Load menu

2. Set the desired storage location. The file manager dialog of the selected location is displayed.

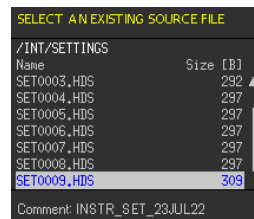

Figure 6-4: File manager of the selected location

3. Rotate the rotary knob to select desired filename in the file manager.
4. Select "LOAD" to load the selected file.
5. Select "Delete file" to delete selected file.
6. Confirm file deletion with "Delete file" again.
7. To load factory default settings, select "Default Settings" softkey item to reset instrument settings back to factory default settings.

The R&S NGC100 recalls /deletes the instrument settings from the file.

Settings

SAVE.....	96
L STORAGE.....	96
L FILENAME.....	96
L COMMENT.....	96
L SAVE.....	97
LOAD.....	97
L Remove directory.....	97
L Delete file.....	97
L LOAD.....	97
Default Settings.....	97

SAVE

Saves device settings.

Remote command:

*[SAV](#) on page 135

STORAGE ← SAVE

See "[STORAGE](#)" on page 88.

FILENAME ← SAVE

Sets filename for device settings.

Remote command:

n.a.

COMMENT ← SAVE

Sets comment on the filename for device settings.

Remote command:
n.a.

SAVE ← SAVE
Confirms save device settings.

Remote command:
n.a.

LOAD
Loads device settings.

Remote command:
[*RCL](#) on page 136

Remove directory ← LOAD
Removes selected directory in the USB stick.

Remote command:
n.a.

Delete file ← LOAD
Deletes selected file.

LOAD ← LOAD
Loads selected file for device settings.

Remote command:
n.a.

Default Settings
Resets device settings to factory default.

Remote command:
[*RST](#) on page 134

6.2 Screenshot



You can only save a screenshot if a USB stick is connected to the USB connector on the front panel. See "[USB connector \(7\)](#)" on page 29.



Screenshot shortcut key

Press and hold the [Help] key to capture and save the screenshot according to the configured settings.

With the screenshot function, you can capture the image of the current screen and save it in a graphic file.

Access:

1. Select "Screenshots" to configure screenshots settings.
The R&S NGC100 displays the screenshots menu.



2. Set desired filename, color mode and file format for the screenshot file.
3. Select "SAVE" to save the screenshot.
Note: The "SAVE" function is available only if you have a USB stick connected.
[HCOPY:DATA?](#) on page 175
[HCOPY:SIZE:X?](#) on page 176
[HCOPY:SIZE:Y?](#) on page 176

Settings

STORAGE	98
FILENAME	98
Color & Format	98
L FORMAT	98
L COLOR MODE	99
SAVE	99

STORAGE

Opens the file manager dialog of the USB stick location.

Remote command:

n.a.

FILENAME

Sets the screenshot filename.

For screenshots, the R&S NGC100 assigns the default filename SCRxxxx where "xxxx" refers to an incremental index starting from "0001".

Remote command:

n.a.

Color & Format

Sets color and format for screenshot.

FORMAT ← Color & Format

Sets format for screenshot.

"BMP" Screenshot is saved as bitmap image file format.

"PNG" Screenshot is saved as portable network graphic format.

Remote command:

[HCOPY:FORMat](#) on page 176

COLOR MODE ← Color & Format

Sets color mode for screenshot.

"Grayscale" Screenshot is saved in black and white color mode.

"Color" Screenshot is saved in color mode.

Remote command:

n.a.

SAVE

Saves current display in screenshot.

Function is available only if USB stick is connected.

Remote command:

[HCOPY:DATA?](#) on page 175

7 General instrument functions

The following chapters provide the general instrument information and utilities services in R&S NGC100, regardless of the selected operating mode and measurement.

Access:

1. Press [Setup] key.
The R&S NGC100 displays setup menu.

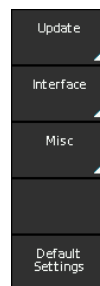

Figure 7-1: Setup menu

2. Select corresponding softkey menu to access instrument settings and utilities services.

- [Update \(firmware\)](#)..... 100
- [Remote control interface](#)..... 101
- [Miscellaneous](#)..... 102
- [Default settings](#)..... 111

7.1 Update (firmware)

The update functionality provides information on the currently installed firmware version. Using the USB interface at the front panel, you can update the firmware.

We recommend that you use the latest firmware version available on the product page at www.rohde-schwarz.com/firmware/ngc100.

Required equipment

- Software:
Firmware update file RS_NGCxxx_Firmware_<version>.zip
After downloading the ZIP file, unpack the data to the base directory of a USB stick and connect the USB stick to the USB port of the power supply.
- Hardware:
USB memory stick with enough free space to save the update file.
The memory stick does not need to be bootable and previous data on the stick is not affected. Several update files can reside on the stick in parallel. During update procedure, the stick is not modified by the instrument.

The USB flash drive file system supports a maximum capacity of up to 4GByte, FAT32 only. See also [Chapter 3.1.9, "Connecting USB devices"](#), on page 26.

To update the instrument firmware

1. Download the latest version of the R&S NGC100 firmware from the Rohde & Schwarz website.
The compressed firmware *.zip file unpacks during download automatically.
2. Save the file in the root directory of the USB memory stick.
3. Connect the USB memory stick to the USB interface at the front panel of the R&S NGC100.
4. Select [Setup] > "Update" > "Firmware" softkey item to update instrument firmware. This results in a search for the corresponding file on the USB stick. The information for the new firmware to be installed is displayed on the row labeled "NEW". If the installed firmware is up to date, the R&S NGC100 displays the device firmware information in red. Green text indicates a more recent version that can be installed.

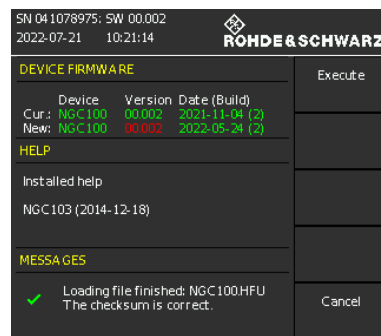

Figure 7-2: Firmware update menu

5. **NOTICE!** Risk of potential damage to the firmware. Disconnecting the power supply while an update is in progress leads to missing or faulty firmware. Take special care not to disconnect the power supply while the update is in progress. Interrupting the power supply during the firmware update can lead to an unusable instrument which needs to be sent in for maintenance.
Select "Execute" if version number is marked in green.
The firmware update starts.

7.2 Remote control interface

The R&S NGC100 provides several interfaces to establish a remote control connection. The "Interfaces" dialog provides the corresponding parameters for configuration.

Access:

1. Select [Setup] > "Interface" softkey item to configure the interface settings.

The R&S NGC100 displays the "Interface" menu.



Figure 7-3: Interface menu

2. Select the corresponding interface to communicate with the instrument remotely.
 - [VCP \(Virtual COM port\)](#)
 - [USB \(TMC\)](#)
 - [Ethernet \(IP address, subnet mask etc.\)](#)
 - [IEEE-488 GPIB interface \(GPIB address\)](#)
3. To configure the required access parameters, see [Chapter 8.1, "Remote control interfaces and protocols"](#), on page 112.

7.3 Miscellaneous

The miscellaneous menu allows you to get an overview of the device information, access to utilities services such as the configuration of date, time, sound, etc. of the instrument.

Access:

1. Select [Setup] > "Misc" softkey item to configure the interface settings.
The R&S NGC100 displays the "Misc" menu.

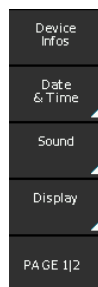

Figure 7-4: Miscellaneous menu

2. Select the corresponding utilities services for settings.
 - [Chapter 7.3.1, "Device information"](#), on page 103
 - [Chapter 7.3.2, "Date time"](#), on page 104
 - [Chapter 7.3.3, "Sound"](#), on page 105

- [Chapter 7.3.4, "Display settings"](#), on page 106
 - [Chapter 7.3.5, "Key brightness"](#), on page 107
 - [Chapter 7.3.6, "Device name"](#), on page 108
 - [Chapter 7.3.7, "CSV"](#), on page 108
 - [Chapter 7.3.8, "Power up"](#), on page 110
3. To return to "Misc" menu, press the  key.

7.3.1 Device information

The "Device infos" allows you to get an overview on the configuration of your instrument. You can retrieve information on the instrument model, its hardware components and interfaces using the device information function.

Access:

- ▶ Select [Setup] > "Misc" > "Device Infos" to get an overview of the instrument configuration.

The R&S NGC100 displays details of the instrument assemblies and remaining available internal memory.



Figure 7-5: Instrument information

Device Information

Displays the main instrument information.

"<instrument model> (<HW ID:xxx)"	Designation of the instrument and its hardware identification number.
"Serial No.:"	Serial number of the instrument.
"Device Name"	Name of the instrument name. To assign a name, see Chapter 7.3.6, "Device name" , on page 108.
"Version"	Currently installed firmware version. How to: see Chapter 7.1, "Update (firmware)" , on page 100
"Build 2"	Version of the firmware package with time stamp.
"Hardware IDs"	Installed hardware modules, software and firmware versions.
"Interface"	Information on the set remote control interface, including hardware ID and software version.

"Available internal memory" Available amount of memory.

Remote command:

*IDN? on page 134

SYSTem:VERSiOn? on page 138

7.3.2 Date time

The "Date & Time" allows you to set the time and date and add a date and time stamp to printouts and saved data records.

Access:

1. Select [Setup] > "Misc" > "Date & Time" to set date and time settings.
The R&S NGC100 displays "Date & Time" menu.

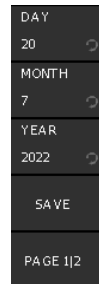

Figure 7-6: Date time menu

2. Adjust the corresponding date and time setting via rotary knob.
The respective softkey menu item is activated when marked in yellow.
3. Select "SAVE" to confirm the changes.

Settings

DAY/MONTH/YEAR.....	104
SAVE.....	104
HOUR/MINUTES.....	105

DAY/MONTH/YEAR

Sets the day/month/year of the date.

Remote command:

n.a.

SAVE

Confirms current settings for the date and time values.

Remote command:

n.a.

HOUR/MINUTES

Sets the hour/minutes of the time.

Hour settings in 24-hour format.

Remote command:

n.a.

7.3.3 Sound

The "Sound" allows you to issue a signal in the event of an error (or simply as a control measure).

Access:

1. Select [Setup] > "Misc" > "Sound" to setup alert settings.
The R&S NGC100 displays "Sound" menu.



Figure 7-7: Sound menu

2. Select the desired beeper alert.
Selected softkey item is marked in blue.
[SYSTEM:BEEPer:STATe](#) on page 137
[SYSTEM:BEEPer\[:IMMEDIATE\]](#) on page 137

Settings

CTRL BEEP	105
ERROR BEEP	105

CTRL BEEP

Beeps immediately when the instrument receives a remote control command.

"ON" Beeps on received control command.

"OFF" No beep.

Remote command:

n.a.

ERROR BEEP

Generates an acoustic signal when an error occurs.

"ON" Beeps on error.

"OFF" Error beeper alert is deactivated.

Remote command:

n.a.

7.3.4 Display settings

The "Display" enables you to customize the appearance of the screen in brightness and contrast. You can also adjust the grid intensity for graphical display.

Access:

1. Select [Setup] > "Misc" > "Display" to access display settings.
The R&S NGC100 shows "Display" menu.

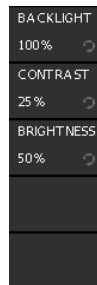

Figure 7-8: Display menu

2. Adjust the corresponding display settings via rotary knob.
The respective softkey menu item is activated when marked in yellow.

Settings

BACKLIGHT.....	106
CONTRAST.....	106
Brightness.....	106

BACKLIGHT

Sets the screen intensity of the display in percent.

Range: 10 % to 100 %

Remote command:

n.a.

CONTRAST

Sets the contrast of the display in percent.

Range: 10 % to 100 %

Remote command:

n.a.

Brightness

Sets the brightness of the display for the graphical representation in percent.

Range: 10 % to 100 %

Remote command:

n.a.

7.3.5 Key brightness

The R&S NGC100 enables you to customize the brightness of the keys. You can also determine the fallback time. When this time has expired, the instrument accepts a changed value and exits the setting dialog automatically.

Access:

1. Select [Setup] > "Misc" > "PAGE 1/2" > "Key" to set key brightness.
The R&S NGC100 displays the "Key" menu.

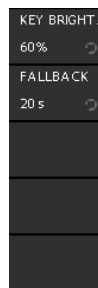

Figure 7-9: Key menu

2. Adjust the corresponding key settings via rotary knob.
The respective softkey menu item is activated when marked in yellow.

Settings

KEY BRIGHT.....	107
FALLBACK.....	107

KEY BRIGHT.

Sets the intensity of the key illumination in percent.

Range: 10 % to 100 %

Remote command:

n.a.

FALLBACK

Sets the key "FALLBACK". This parameter determines the time period that the instrument waits before it automatically assigns a changed value. If you confirm the setting manually before the fallback time expires, the setting has no effect.

"5s", "10s", Sets the corresponding time period.

"20s"

"Off" Disables the function.

Remote command:
n.a.

7.3.6 Device name

With "Device name" menu, you can customize the device name of the instrument.

Access:

- ▶ Select [Setup] > "Misc" > "PAGE 1/2" > "Device name" to set instrument name. The R&S NGC100 displays the on-screen keypad for alphanumeric entry.

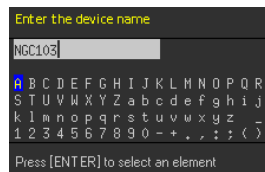

Figure 7-10: On-screen keypad for alphanumeric entry

To configure device name

1. Enter the desired instrument name.
See also ["Entering alphanumeric parameters"](#) on page 44.
2. Complete the entry with the "Accept" softkey.
The "Device name" is assigned. The R&S NGC100 indicates the assigned device name in the window [Figure 7-5](#).

Settings

[Device name](#)..... 108

Device name

Sets device name.

For details, see ["Device Information"](#) on page 103.

7.3.7 CSV

The "CSV" menu defines the table separators and decimal floating point for the data, saved in standard *.csv or .txt file format.

About CSV

The R&S NGC100 enables you to record measurement readings and save the data in a file for subsequent evaluation and validation. Recorded data consists of character strings that list general metadata, as, e.g., date, device name, etc., the parameter names and the acquired measurement values.

The standard file formats *.csv or .txt, which The R&S NGC100 saves the data in , allow you to use a spreadsheet application program for analysis and evaluation. A spreadsheet program displays the data either as numerals and text, or in graphical form.

Consideration on data content depending on the used application

During a measurement, gaps can occur due to high process load, measurement speed or exceeding file size. It can also occur that a measured parameter was not displayed caused by configuration or exceeded ranges. The gaps result in empty cells designated as "nan" (not a number).

Consider, that not all spreadsheet applications can evaluate "nan" as a 0, which leads to erroneous results, shown in the example.

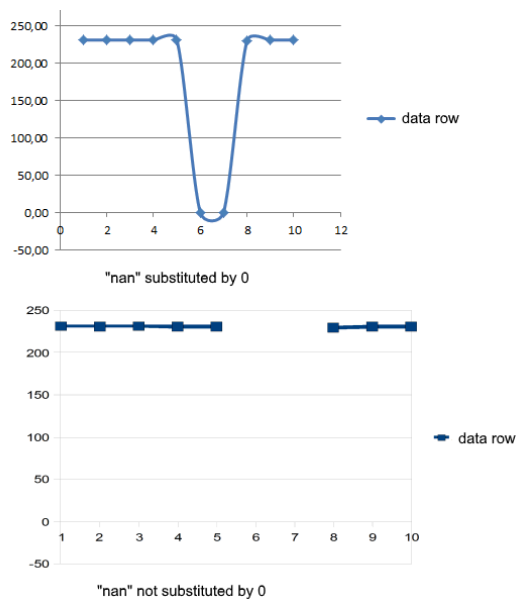

Figure 7-11: "nan"- with correct and erroneous empty cell evaluation

Therefore, the R&S NGC100 provides a correction function that fills empty cells with 0. Consider the capability of the application that you use, and set the function correction correspondingly.

Access:

1. Select [Setup] > "Misc" > "PAGE 1/2" > "CSV" to set data separators for data saved in the file.

The R&S NGC100 displays the csv menu for configuration.

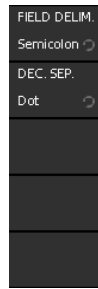

Figure 7-12: CSV menu

2. Select the desired data separator for setting.

Settings

FIELD DELIM.....	110
DEC SEP.....	110

FIELD DELIM.

Selects the line separator between individual parameters or values.

"Semicolon" Separates the data entries by a semicolon.

"Comma" Uses a comma.

Remote command:

n.a.

DEC SEP.

Sets the decimal point represented in data.

"Comma" Comma is used as the decimal point.

"Dot" Dot is used as a decimal point.

Remote command:

n.a.

7.3.8 Power up

Customize the power-up mode after AC loss.

Access:

1. Select [Setup] > "Misc" > "PAGE 1/2" > "POWER UP" to set power up model.
The R&S NGC100 displays the power-up menu.



Figure 7-13: Power-up menu

2. Enter the desired power-up mode.

Settings

POWER UP	111
--------------------------------	-----

POWER UP

Sets power-up mode after AC loss.

"Last State" Default setting. The R&S NGC100 startup if last state was ON, otherwise it goes into standby mode if AC power is available.

"ON" The R&S NGC100 startup if AC power is available.

"OFF" The R&S NGC100 goes into standby mode if AC power is available.

Remote command:

n.a.

7.4 Default settings

The R&S NGC100 resets all the miscellaneous settings to default settings with the exception of [Date, time](#) and [device name](#) settings.

Access:

- ▶ Select [Setup] > "Default Settings" softkey item to reset the instrument miscellaneous settings. See [Chapter 7.3, "Miscellaneous"](#), on page 102.

The R&S NGC100 resets all miscellaneous settings with exception on the [Chapter 7.3.2, "Date time"](#), on page 104 and [Chapter 7.3.6, "Device name"](#), on page 108 settings.

Settings

Default Settings	111
--	-----

Default Settings

Resets all the miscellaneous settings to default settings with the exception of [Date, time](#) and [device name](#) settings.

Remote command:

*[RST](#) on page 134

8 Network operation and remote control

As an alternative to the interactive operation directly at the instrument, you can operate the R&S NGC100 also from a remote control location, for example a controller PC.

The interfaces of the R&S NGC100 provide flexible access to the instrument. [Figure 8-1](#) shows the possibilities of the physical connection (interfaces) for remote access.



The following descriptions provide information required for operating the R&S NGC100 remotely. The information applies to all applications and operating modes supported by the instrument. Definitions specified in the SCPI standard are not provided.

For basic knowledge on remote control operation and additional information, see the following documents available from the Rohde & Schwarz website:

- [Remote control via SCPI](#)
- [1MA171: How to use Rohde & Schwarz Instruments in MATLAB](#)
- [1SL374: How to communicate with R&S devices using VISA](#)
- [Rohde-Schwarz - Remote control examples](#)

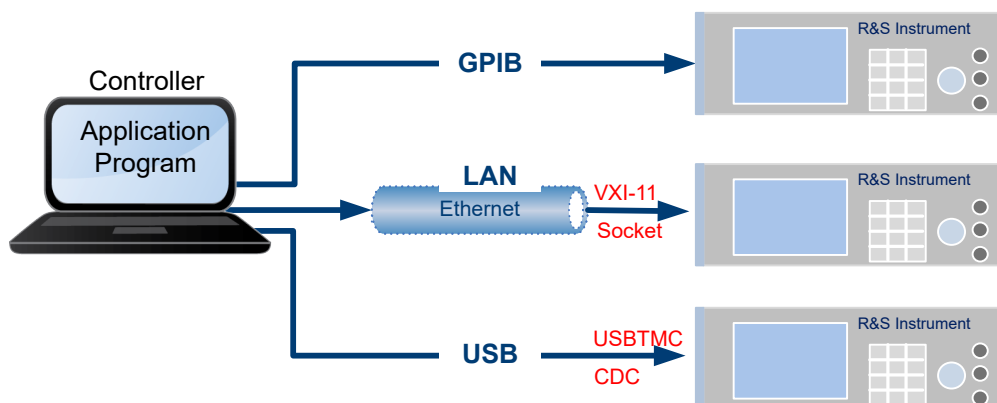

Figure 8-1: Supported remote connections

- [Remote control interfaces and protocols](#)..... 112
- [Setting up remote control connection](#)..... 124
- [Starting and stopping remote control](#)..... 127
- [Status reporting system](#)..... 128

8.1 Remote control interfaces and protocols

The R&S NGC100 comes with the following interfaces for remote control:

- [Ethernet \(LAN\) interface](#)
- [USB standard interface](#)
- [IEEE-488 bus interface \(GPIB\)](#) (instrument models R&S NGCxxx-G)

You need a connection between the R&S NGC100 and the controller PC. An application software that supports communication over the used interfaces must be installed on the controller PC. [Table 8-1](#) gives an overview on the connectivity:

Table 8-1: Remote control interfaces and protocols

Interface	Protocols, VISA ¹ address string and library	Remarks
Local area network (LAN)	<ul style="list-style-type: none"> • VXI-11 TCP/IP::host address[:: LAN device name][::INSTR] VISA • Socket communication (Raw Ethernet, simple Telnet) TCP/IP::host address[:: LAN device name]::<port>::SOCKET VISA or socket controller 	<p>The LAN connector at the rear panel of the instrument.</p> <p>The interface is based on TCP/IP, see Chapter 8.1.1, "LAN interface", on page 114.</p>
USB	<ul style="list-style-type: none"> • USBTMC USB::<vendor ID>::<product ID>:: <serial number>[::INSTR] VISA • CDC (communications device class, corresponds to VCP (virtual COM port)) 	<p>The USB Type-B connector is at the rear panel of the instrument.</p> <p>For a description of the interface, refer to Chapter 8.1.2, "USB interface", on page 118</p>
GPIB (IEC/IEEE Bus Interface) (instrument model R&S NGC100-G)	<ul style="list-style-type: none"> • – GPIB::<address>[::INSTR] (no secondary address) VISA (optional) 	<p>The GPIB bus interface according to standard IEC 625.1/IEEE 488.1 is at the rear panel.</p> <p>For a description of the interface, see Chapter 8.1.3, "GPIB interface (IEC/IEEE bus interface)", on page 120.</p>

¹) VISA (Virtual Instrument Software Architecture) is a standardized software interface library providing input and output functions to communicate with instruments. A VISA installation on the controller is a prerequisite for remote control over LAN and USB interface. For remote control over socket communication VISA installation is optional. When using socket communication or the GPIB interface (if applicable), VISA installation is optional. For basic information, see [Remote control via SCPI](#).



Rohde & Schwarz provides the standardized I/O software library R&S VISA for download at the Rohde & Schwarz website <http://www.rohde-schwarz.com/rsvisa>.

There are various of ways how the R&S NGC100 can be remotely accessed and controlled.

Access:

- ▶ Select [Setup] > "Interface" key to configure the required interface.
The R&S NGC100 displays the available interface options which enable you to access the setting parameters of the interfaces the instrument is equipped with.



Figure 8-2: Interface menu

8.1.1 LAN interface

The R&S NGC100 is equipped with a network interface and can be connected to an Ethernet LAN (local area network). If you have assigned the corresponding rights, you can use this interface for remote control and data transfer from a controller PC. Make sure that you have connected the controller PC in the same network.

To establish a network connection, connect a commercial RJ-45 cable to the LAN port of the instrument and to a PC or network switch.

For more information on the connection, see [Chapter 8.2.1, "LAN connection"](#), on page 124.

Depending on the network capacities, the TCP/IP address information for the instrument can be obtained in different ways.

- If the network supports dynamic TCP/IP configuration using the dynamic host configuration protocol (DHCP), and a DHCP server is available, all address information can be assigned automatically.
- Otherwise, the address must be set manually. Automatic private IP addressing (APIPA) is not supported.

By default, the instrument is configured to use dynamic TCP/IP configuration and obtain all address information automatically. This means that it is safe to establish a physical connection to the LAN without any previous instrument configuration.

1. **NOTICE!** Risk of network failure. Before connecting the instrument to the network or configuring the network, consult your network administrator. Connection errors may affect the entire network.

If your network does not support DHCP, or if you choose to disable dynamic TCP/IP configuration, you must assign valid address information before connecting the instrument to the LAN. Contact your network administrator to obtain a valid IP address.

2. Connect a LAN cable to the [LAN port](#).
See also [Chapter 8.2.1, "LAN connection"](#), on page 124.
3. For manual configuration, select [Setup] > "Interface" > "Ethernet" > "PARAMETER" softkey items.

The R&S NGC100 displays the Ethernet dialog.

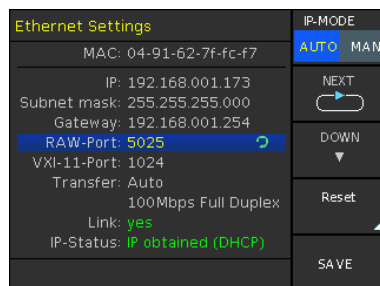

Figure 8-3: Ethernet dialog

In this dialog, you can configure the settings of the general network environment and specific identification parameters of the instrument in the network. The R&S NGC100 displays the VISA resource strings and additional parameters for information on the LAN interface, and the status of the connection.

To manually configure Ethernet settings

By default, the R&S NGC100 is configured to use dynamic TCP/IP configuration and to obtain the whole address information automatically. If the network does not support DHCP, you can assign the IP address manually.

1. Configure the required Ethernet settings, see ["Settings"](#) on page 116.
Use "NEXT" softkey item to navigate the settings in the IP address.
Use "DOWN" softkey item to navigate the different settings in the Ethernet dialog.
2. Select "SAVE" to complete the configuration.
3. Press [Back] key to exit the dialog.

To assign the IP address manually on the controller PC

- Obtain the necessary information from your network administrator. If you use more than one LAN connector, you need separate address information for each connector.
For information on how to configure the LAN settings, refer to the documentation of the operating system the PC uses.

To check the LAN connection

You have several possibilities, to validate if the LAN connection is established and working properly:

1. Check the LAN connection using ping: `ping <IP address>`.
2. If the PC can access the instrument, enter the IP address of the address line of the Internet browser on your computer: `http//:xxx.yyy.zzz.xxx`

The "Device Information" page appears. It provides information on the instrument and the LAN connection. See [Figure 8-7](#)

Settings

IP Mode.....	116
MAC Address.....	116
IP.....	116
Subnet Mask.....	116
Gateway.....	116
RAW-Port.....	117
VXI-11-Port.....	117
Transfer.....	117
Link.....	117
IP-Status.....	117
Reset.....	117
SAVE.....	118

IP Mode

Selects the mode for assigning the IP address.

"MAN"	Enables you to assign the IP address manually.
"AUTO"	Assigns the IP address automatically, provided the network supports DHCP.

Remote command:

n.a.

MAC Address

Indicates the MAC (Media Access Control) address, a unique identifier of the network adapter in the R&S NGC100.

The MAC address is assigned statically and cannot be modified.

Remote command:

n.a.

IP

Displays the IP address of the instrument in the network. This address is manually configured if [IP Mode](#) is set to "MAN".

Remote command:

n.a.

Subnet Mask

Displays the bit group of the subnet in the host identifier. This address is manually configured if [IP Mode](#) is set to "MAN".

Remote command:

n.a.

Gateway

Displays the gateway address.

This address identifies the router on the same network as the instrument that is used to forward traffic to destinations beyond the local network. This address is manually configured if [IP Mode](#) is set to "MAN".

Remote command:
n.a.

RAW-Port

Displays the visa resource string for remote control over LAN, using TCP/IP socket protocol. This port is manually configured if **IP Mode** is set to "MAN".

Remote command:
n.a.

VXI-11-Port

Displays the visa resource string for Ethernet instruments.

Remote command:
n.a.

Transfer

Selects the mode to determine the parameters of the communication channel.

Auto	Mode of communication channel is determined automatically.
"Manual 10/100Mbps Half Duplex"	10/100Mbps data transfer in one direction on the communication channel.
"Manual 10/100Mbps Full Duplex"	10/100Mbps data transfer in both directions on the communication channel.

Remote command:
n.a.

Link

Displays the status of the LAN connection. "Yes" in green letters denotes that the over LAN is active.

Remote command:
n.a.

IP-Status

Indicates whether the LAN connection is active (green color), and displays the setting of the IP mode.

Remote command:
n.a.

Reset

Restores the LAN settings to factory default.

"CONFIRM" Confirm the factory default settings.

"ABORT" Abort the factory default settings.

Remote command:
[*RST](#) on page 134

SAVE

Saves static IP settings.

Remote command:

n.a.

8.1.2 USB interface

You can use the USB B interface for remote control and data transfer from a controller PC. Remote control over USB requires the VISA library.

Connect a double-shielded USB cable between the **USB port** and PC for a USB connection. The R&S NGC100 supports "**USB TMC**" and "**USB VCP**" connection.

For more information on connection, see **Chapter 8.2.2, "USB connection"**, on page 126.

Access:

- ▶ Select [Setup] > "Interface" to select the desire USB interface.
For details, see "**USB VCP**" on page 118 and "**USB TMC**" on page 118.

USB VCP



The following requirements for USB-VCP driver installation are necessary:

- A PC with operating system Windows XP, VISTA, Windows 7, Windows 8 (32Bit or 64Bit), Windows 10 or Windows 11.
- Administrator rights are necessary for the installation of the driver.

The USB virtual COM port (USB-VCP) is a software interface that allows the communication to the R&S NGC100 using any terminal program (e.g. HMExplorer) via SCPI commands once the corresponding Windows drivers have been installed. The actual USB-VCP driver and software HMExplorer can be downloaded for free from the product homepage (<http://www.rohde-schwarz.com/product/ngc100>).

If a connection between PC and the instrument has been established and no R&S NGC100 USB-VCP driver is installed, the PC operating system displays a "Found New Hardware" wizard. In this case, the R&S NGC100 USB-VCP driver must be installed.

The HMExplorer window application provides the R&S NGC100 a terminal function and also the option to create screenshots and editor function to create the EasyArb table.

For more information of the driver installation and HMExplorer window application, see the installation guide of the driver file and the internal HMExplorer help.

USB TMC

The USB Test & Measurement class (USB-TMC) is a protocol that allows GPIB-like communication via USB interfaces and is a separate instrument class of the USB spec-

ification. The USB-TMC protocol supports service queries, triggers, and other GPIB-specific instructions.

VISA drivers are installed and that it can be used directly in the corresponding environments. The driver is included in the NI-VISA package and can be downloaded at <http://www.ni.com/downloads/ni-drivers/>.

A major benefit of the USB TMC class is that by sampling specific registers, the controlling software can determine if commands have been terminated and if they have been processed correctly. With USB-VCP, communication with instrument requires analysis and polling mechanisms within the controlling software which may significantly strain the interface of the measurement instruments. The TMC status registers solve this problem with the USB TMC in the same manner as in the case with the GPIB interface for the hardware via the corresponding control lines.



HMExplorer

The window application supports the communication via LAN and USB VCP only.

For more information of the VISA driver installation, see the installation guide of the VISA driver file.

Once the driver is installed, the "USB Test and Measurement Device (IVI)" is displayed in the "Device Manager" window, see [Figure 8-4](#).

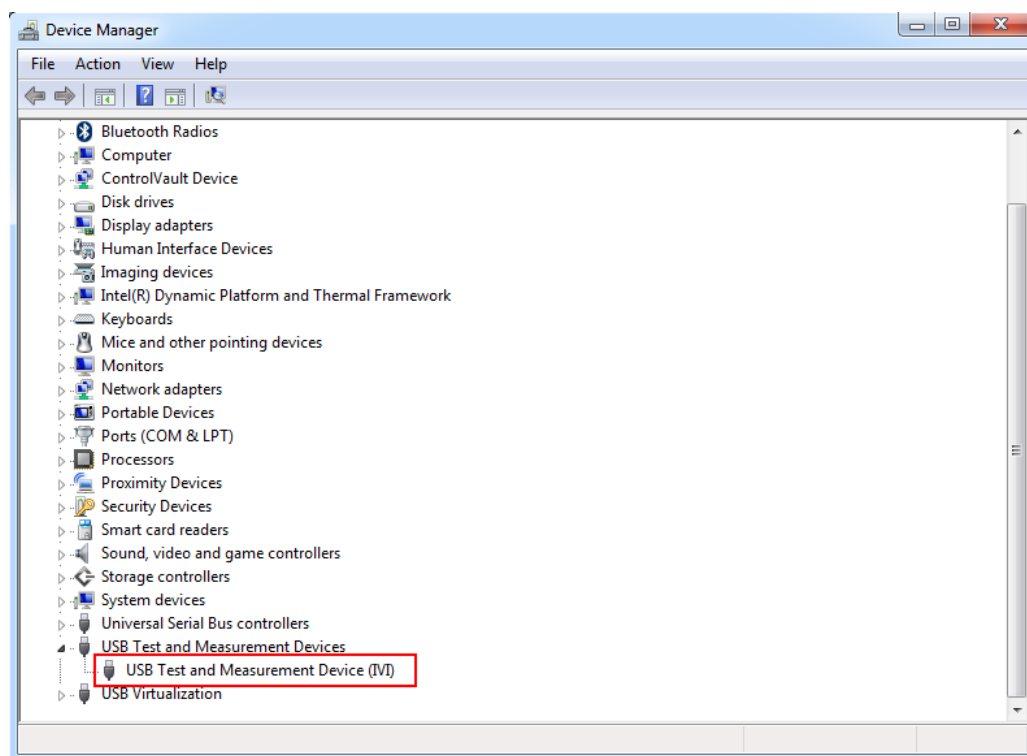

Figure 8-4: Device manager

Settings

USB VCP	120
USB	120

USB VCP

Sets "USB VCP" as instrument interface.

For details, see "[USB VCP](#)" on page 118.

USB

Sets "USB" as instrument interface.

For details, see "[USB TMC](#)" on page 118.

8.1.3 GPIB interface (IEC/IEEE bus interface)

The R&S NGCxxx-G models are equipped with an integrated GPIB interface at the [rear panel](#).

The GPIB interface sometimes called the General Purpose Interface Bus (GPIB), is a general purpose digital interface system that can be used to transfer data between two or more devices. Some of its key features are:

- Up to 15 instruments can be connected
- The total cable length is restricted to a maximum of 15 m; the cable length between two instruments should not exceed 2m
- A wired "OR" connection is used if several instruments are connected in parallel

GPIB instrument address

To operate the instrument via remote control, it must be addressed using the GPIB address. Connect the IEC 625/IEEE 488 connector of the R&S NGC100 to the controller PC with a double-shielded GPIB bus interface cable.

For more information on the connection, see [Chapter 8.2.3, "GPIB connection"](#), on page 126.

Access:

- ▶ Select [Setup] > "Interface" > "IEEE488" > "PARAMETER" to set the GPIB address of the instrument.

The R&S NGC100 displays the GPIB address menu.



Figure 8-5: GPIB address menu

To assign the GPIB (IEE488) address

1. Select "ADDRESS" softkey item to set the GPIB address.
2. Enter the required value.
3. Select "SAVE" to confirm the setting.
The controller must address the instrument with the GPIB bus address.

To assign the IEE488 address manually on the controller PC

- ▶ Obtain the necessary information from your network administrator. If you use more than one LAN connector, you need separate address information for each connector.
For information on how to configure the LAN settings, refer to the documentation of the operating system the PC uses.

Settings

PARAMETER.....	121
L ADDRESS.....	121
L SAVE.....	121

PARAMETER

Sets the GPIB interface parameter.

ADDRESS ← PARAMETER

Sets the GPIB address.

SAVE ← PARAMETER

Confirms the setting of GPIB address.

8.1.4 LXI browser interface

LAN extension for instrumentation (LXI) is a platform for measuring devices and test systems based on standard Ethernet technology. LXI is to be the LAN-based successor to GPIB and combines the advantages of Ethernet with the simple and familiar features of the GPIB. This standard provides a new standard for network configuration of

front panel devices via a WEB interface. The central tool for this type of configuration is a browser.

LXI-compatible devices are divided into three classes, A, B and C, where the functionality of the classes is based on each other hierarchically:

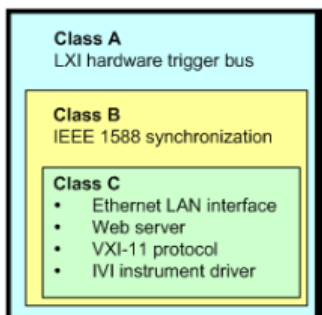

Figure 8-6: LXI classes

- Class C devices are characterized by a uniform LAN implementation including an ICMP ping responder for diagnostic purposes. Devices can be configured with a WEB browser.
A LAN Configuration Initialize (LCI) mechanism resets the LAN configuration. Class C LXI devices are also intended to support automatic detection in a LAN via VXI-11 discovery protocol and programming using IVI drivers.
- Class B adds the IEEE 1588 Precision Time Protocol (PTP) and peer-to-peer communication to base class C. With IEEE 1588, all devices within a network can automatically synchronize to the most accurate available clock, and then provide time-stamps or synchronization signals for all devices with exceptional accuracy.
- Class A devices also contain the eight-channel hardware trigger bus (LVDS interface) according to the LXI standard.

Class A and B devices can send and receive software triggers through LAN messages and communicate with each other without using the controller.

The power supplies of the R&S NGC100 series meet the general requirements of the LXI Class C and correspond to the version 1.5 (LXI Core 2016). Advanced features are not supported.

A key component of an LXI certification is the IVI device driver (Interchangeable Virtual Instrument). Here IVI.NET drivers are provided, which are based on the .NET framework 4 of Microsoft. LabView and LabWindows/CVI drivers built on LabWindows/CVI 2012 are also available. The latest copy of the IVI.NET driver is available for download from the product homepage <http://www.rohde-schwarz.com/product/ngc100>.

In addition to the features described above, the device provides the following LXI-related functions:

- Displays the current device settings
- Remote control of the device within the WEB-Browser

The Ethernet interface has an integrated web server, you can access the instrument with its corresponding IP address in the address line of the browser. See [Figure 8-7](#).



The screenshot shows the Rohde & Schwarz web browser interface. On the left, there is a navigation menu with options: Device, Settings, Security, and Terminal. Below the menu is the LXI logo. On the right, there is a 'Device Information' section with the following details:

Device Information	
Device Model	NGC103
Manufacturer	Rohde&Schwarz
Serial Number	041078975
Description	Rohde&Schwarz NGC103 - 041078975
LXI Extended Functions	None
LXI Version	1.4 (LXI Core 2011)
Hostname	R-NGC103-078975.local.
MAC Address	04:91:62:7F:FC:F7
TCP/IP Address	169.254.65.150
Firmwareversion	00.002
Device Address String	TCPIP0::169.254.65.150::5025::SOCKET
Device identification	Enable

Figure 8-7: Instrument web browser view

8.1.5 SCPI

SCPI (Standard Commands for Programmable Instruments) commands - messages - are used for remote control. Commands that are not taken from the SCPI standard follow the SCPI syntax rules. The instrument supports the SCPI version 1999. The SCPI standard is based on standard IEEE 488.2 and aims at the standardization of device-specific commands, error handling and the status registers. The tutorial "Automatic Measurement Control" - A tutorial on SCPI and IEEE 488.2" from John M. Pieper (R&S order number 0002.3536.00) offers detailed information on concepts and definitions of SCPI.

The requirements that the SCPI standard places on command syntax, error handling and configuration of the status registers are explained in detail in the following sections. For more information, see [Chapter 9, "Remote control commands"](#), on page 133 and [Chapter A, "Additional basics on remote control"](#), on page 188.

8.1.6 VISA

VISA is a standardized software interface library providing input and output functions to communicate with instruments. The I/O channel (LAN or USB) is selected at initializa-

tion time by means of a channel-specific resource string. For more information about VISA, refer to its user documentation.

8.2 Setting up remote control connection

The resource string represents an addressing scheme that is used to establish a communication session with the instrument. The following sections show the resource string format used when setting up a remote connection via the various interfaces:



The end character must be set to line feed (LF).

8.2.1 LAN connection

For remote control via a network, the PC and the instrument must be connected over the LAN interfaces to a common network with TCP/IP network protocol. The instruments are connected with a commercial RJ45 cable (shielded or unshielded Twisted-pair CAT 6+).

The TCP/IP network protocol and the associated network services are preconfigured on the instrument. Software for instrument control and (for specified protocols only) the VISA program library must be installed on the controller.



Identifying instruments in a network

If several instruments are connected to the network, each instrument has its own IP address and associated resource string. The controller identifies these instruments by the resource string.

See [Chapter 8.1.1, "LAN interface"](#), on page 114 for configuring the LAN parameters.

The VISA resource string is required to establish a communication session between the controller and the instrument in a LAN. The resource string is a unique identifier, composed of the specific IP address of the instrument and some network and VISA-specific keywords.

To set up the connection, the IP address of the instrument is required. It is part of the resource string used by the program to identify and control the instrument. The resource string has the form:

TCPIP::[<host address>](#)[:[<LAN device name>](#)][:[INSTR](#)]

TCPIP	= designates the network protocol
host address	= designates the IP address or hostname of the instrument
[:LAN device name]	= defines the protocol and the instance number of a subinstrument
[:INSTR]	= indicates the instrument resource class (optional)

The **IP address** (host address/computer name) is used by the programs to identify and control the instrument. It is automatically assigned by the DHCP server the first time that the device is registered on the network.

Example:

If the instrument has the IP address 192.1.2.3, the valid resource string is:

```
TCPIP::192.1.2.3::INST
```

See [Figure 3-2](#).

VXI-11

`TCPIP::<host address>[::inst0][::INSTR]`

[::inst0] = LAN device name indicates that the VXI-11 protocol is used (optional)

[::inst0] selects the VXI-11 protocol by default and can be omitted.

Example:

```
TCPIP::192.1.2.3::INSTR
```

HISLIP

High-Speed LAN Instrument Protocol (HiSLIP) is a TCP/IP-based protocol for remote instrument control of LAN-based test and measurement instruments. It was specified by the IVI Foundation and is intended to replace the older VXI-11 protocol. To start remote control session with HiSLIP, the valid resource string is:

```
TCPIP::192.1.2.3::HISLIP
```

Socket communication

`TCPIP::<host address>::<port>::SOCKET`

TCPIP = designates the network protocol
 host address = designates the IP address or hostname of the instrument
 port = determines the used port number
 SOCKET = indicates the raw network socket resource class

Socket communication requires the specification of the port (commonly referred to as port number) and of "SOCKET" to complete the VISA resource string with the associated protocol used.

The default registered port for socket communication is port 5025. See also [Figure 3-2](#).

Example:

```
TCPIP::192.1.2.3::5025::SOCKET
```

8.2.2 USB connection

See [Chapter 8.1.2, "USB interface"](#), on page 118 for configuring the USB parameters.

For remote control over the USB connection, the PC and the instrument must be connected over the USB B interface at the rear panel of the instrument. Depending on the used USB port, the connection requires the VISA library or a USB VCP driver to be installed.

On the controller, you need to install any application for instrument control, for example the R&S HMEExplorer, and if available, a VISA program library. VISA detects and configures the Rohde & Schwarz instrument automatically when the USB connection is established. You do not have to enter an address string or install a separate driver.

The resource string represents an addressing scheme that is used to establish a communication session with the instrument. It is based on the instrument address and some instrument- and vendor-specific information. The USB resource string syntax is as follows:

- USB TMC

`USB::<<vendor ID>::<<product ID>::<<serial number>[::INSTR]`

USB = denotes the used interface
 <vendor ID> = is the manufacturer ID
 <product ID> = is the product identification of the instrument
 <serial number> = is the individual serial number on the rear of the instrument
 [::INSTR] = indicates the instrument resource class (optional)

Example:

```
USB0::0x0AAD::
0x0197::3657.0005<device_variant>-<device_serial_number>::
INSTR
```

- USB VCP

`ASRL<COM>::INSTR`, where "COM" refers to the COM port number shown on the controlling PC. (e.g. `ASRL15::INSTR`)

8.2.3 GPIB connection

The R&S NGCxxx-G models are equipped with a GPIB interface. The GPIB interface is at the [rear panel](#).

To control the instrument over the GPIB bus interface, the instrument and the controller must be connected with a GPIB bus cable. A GPIB bus card, the card drivers and the program libraries for the programming language used must be provided in the controller.

The controller addresses the instrument within the GPIB bus channel, providing addresses from 0 to 30. The R&S NGC100 has the factory-set address of 20, which you can adjust it according to your environment manually. An instrument preset does not affect the GPIB address.



See [Remote control via SCPI](#) for additional information on the characteristics, control commands and messages of the GPIB interface.

See [Chapter 8.1.3, "GPIB interface \(IEC/IEEE bus interface\)"](#), on page 120 for configuring the GPIB parameters.

To set up the connection, the GPIB address of the instrument is required. It is part of the resource string used by the program to identify and control the instrument over the GPIB interface. The resource string has the form:

```
GPIB<controller_card>::<GPIB_address>::INSTR
```

You can distinguish between the different GPIB controller cards with "GPIB0", "GPIB1", "GPIB2" and etc.



If the VISA implementation supports the GPIB interface, you can optionally define the VISA Instrument Control Resource (INSTR). It is used to define the basic operations and attributes for a device, such as reading, writing, or triggering.

Example:

```
GPIB::28
```

28 is the selected GPIB bus channel.

To change the GPIB address, see [Chapter 8.1.3, "GPIB interface \(IEC/IEEE bus interface\)"](#), on page 120.

8.3 Starting and stopping remote control

When you switch on the instrument, it is always in manual operation state ("local" state). You can operate it using the controls on the front panel. To switch to remote control operation, proceed as follows.

Starting a remote control session

To start remote control:

1. Send a command from the controller.
2. VXI-11 protocol (LAN or USB interface): Use >R interface message.

The instrument switches to remote control and executes the command.

On the screen, a status symbol indicates that remote control is active. The display remains on and you can still operate it manually using the front panel controls.

Returning to manual operation

The instrument switches back to manual operation when the remote connection is closed. But you can return to manual operation manually or via remote control also.

To return to manual control:

1. Select  "UNLOCK" softkey.
2. VXI-11 protocol (LAN or USB interface): Use >L interface message.

The instrument switches to manual control.

8.4 Status reporting system

The status reporting system stores all information on the current operating state of the instrument and errors which have occurred. This information is stored in the status registers and in the error queue. You can query both via RS-232, USB, GPIB or LAN interface (STATus... commands).

8.4.1 Structure of a SCPI status register

Each standard SCPI register consists of 2 or 3 parts (Event, Condition and Enable register). Each part has a width of 16 bits and has different functions. The individual bits are independent of each other, i.e. each hardware status is assigned a bit number which is valid for all 2 or 3 parts. Bit 15 (the most significant bit) is set to zero for all parts. Thus the controller can process contents of the register parts as positive integers.

STATus:QUEStionable:INSTRument:ISUMmary1 exists as often as device channels are available (e.g. R&S NGC103 = 3 channels = 3 status register). Accordingly, the description text of the channel information changes in [Figure 8-8](#) (e.g. instrument 1 = channel 1, instrument 2 = channel 2 etc.).



Depending on the value of the read register, you can draw conclusions on the current status of the device. For example, when the unit operates in constant voltage, the result of the returned ISUM register is a decimal "2" which corresponds the binary value of "0000000000000010".

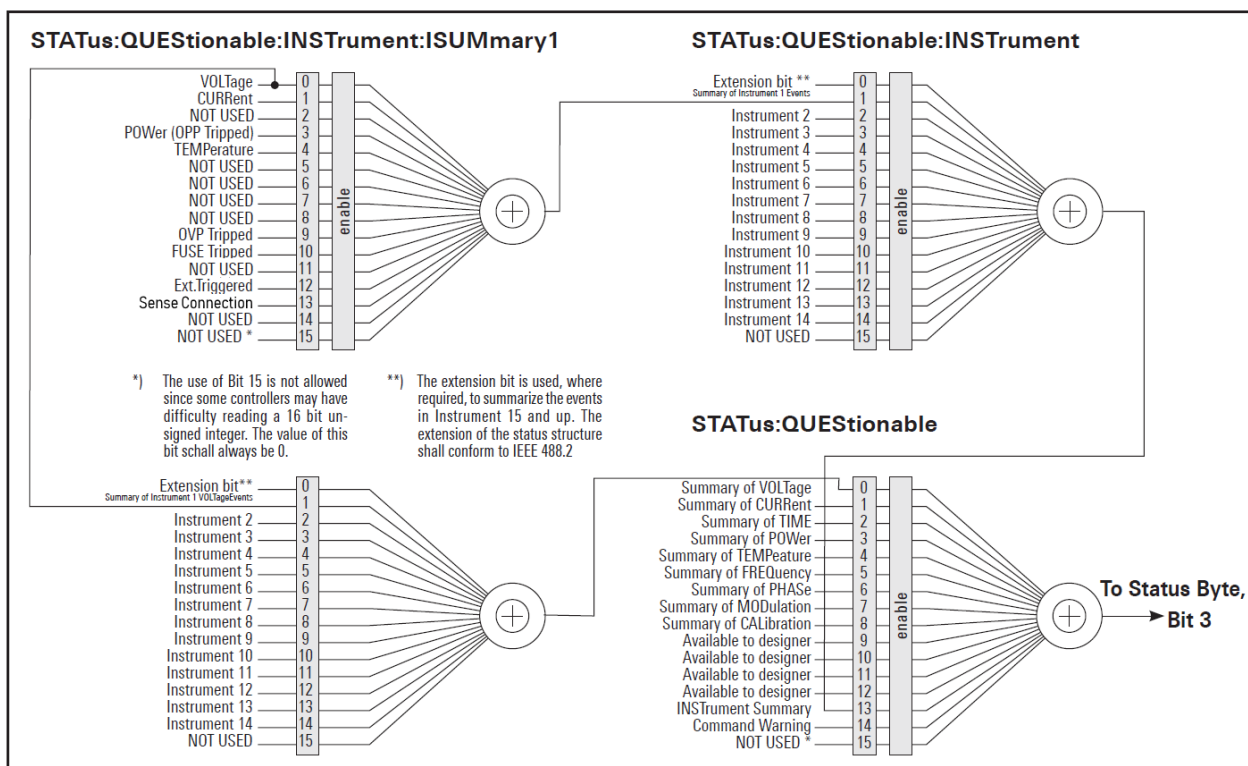

Figure 8-8: Structure of the STATUS:QUESTIONable register

Any part of a status register system can be read by query commands. A decimal value is returned and represents the bit pattern of the requested register. Each SCPI register is 16 bits wide and has various functions. The individual bits are independent, i.e. each hardware status is assigned to a bit number.

Bits 9 to 12 are still "free" resp. unused (always return a "0"). Certain areas of the registers are not used. The SCPI standard defines only the "basic functions". Some devices offer an advanced functionality.

Description of the status register parts

The SCPI standard provides two different status registers:

CONDition

- The CONDition register queries the actual state of the instrument. If you want to query the constant voltage or current mode, you have to use the CONDition register.



The CONDition register delivers a "1" (first bit set) in constant current mode (CC) and a "2" (second bit set) in constant voltage mode (CV).

If the correct channel is selected and the red LED of the channel button lights up (CC mode), the query of the CONDition register must deliver a "1".

Example:

```
STAT:QUES:ISUM1:COND?
```

EVENT

- The `EVENT` status register is set (1) until it is queried. After reading (query), the `EVENT` status register is set to zero.



The description of registers is only used for general explanation. Due to the complexity, we recommend the general accessible SCPI standard document for more detailed information.

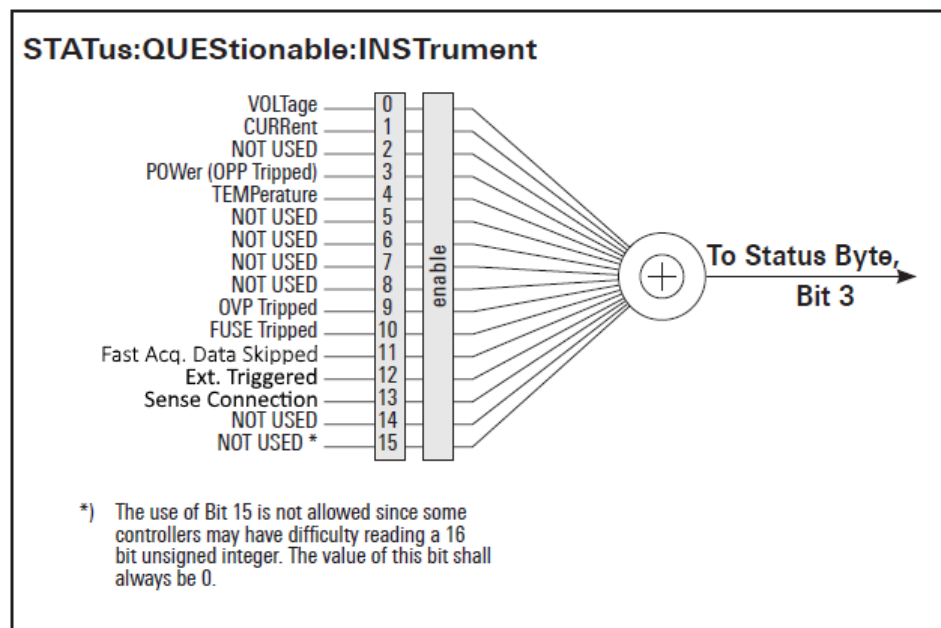

Figure 8-9: Structure of the `status:QUESTIONABLE:INSTRUMENT` register

8.4.2 Contents of the status registers

8.4.2.1 Event status register (ESR) and event status enable register (ESE)

The ESR is defined in IEEE 488.2. It can be compared with the `EVENT` part of a SCPI register. The event status register can be read out using the command `*ESR?`. The ESE corresponds to the `ENABLE` part of a SCPI register. If a bit is set in the ESE and the associated bit in the ESR changes from 0 to 1, the ESB bit in the STB is set. The ESE register can be set using the command `*ESE` and read using the command `*ESE?`.

8.4.2.2 STATus:QUEStionable register

This register contains information about different states which can occur. It can be read using the commands `STATus:QUEStionable:CONDition?` and `STATus:QUEStionable[:EVENT]?`. See [Figure 8-8](#).

Table 8-2: Bits of the STATus:QUEStionable register

Bit No.	Meaning
0	Voltage This bit is set while the instrument is in constant current mode (CC). The voltage is regulated and the current is constant.
1	Current This bit is set while the instrument is in constant voltage mode (CV). The current is variable and the voltage is constant.
2 to 3	Not used
4	Temperature Overrange This bit is set if an over temperature occurs.
5 to 8	Not used
9	OVP Tripped This bit is set if the over voltage protection has tripped.
10	Fuse Tripped This bit is set if the fuse protection has tripped.
11 to 15	Not used
15	This bit is always 0

8.4.2.3 Application of the status reporting system

The purpose of the status reporting system is to monitor the status of one or several instruments in a test system. In particular, it monitors continuous measurements to detect errors in the signal. The controller must receive and evaluate the information of all devices.

The following standard methods are used:

- Query of a specific register by commands
- Query of the error queue

These methods are described in the following sections.

Query of an instrument status

Each part of any status register can be read using queries.

There are two types of commands:

- The common commands `*ESR?`, `*IDN?`, `*STB?` query the higher-level registers.
- The commands of the `STATus` system query the SCPI registers (`STATus:QUEStionable`)

The returned value is always a decimal number that represents the bit pattern of the queried register. This number is evaluated by the controller program.

Decimal representation of a bit pattern (binary weights)

The STB and ESR registers contain 8 bits, the status registers 16 bits. The contents of a status register are specified and transferred as a single decimal number. To make this possible, each bit is assigned a weighted value. The decimal number is calculated as the sum of the weighted values of all bits in the register that are set to 1.

Bits	0	1	2	3	4	5	6	7	...
Weight	1	2	4	8	16	32	64	128	...

Figure 8-10: Decimal representation of a bit pattern

8.4.3 Error queue

Each error state in the instrument leads to an entry in the error queue. The entries of the error queue are detailed plain text error messages. You can look them up in the error log or via remote control using `SYSTem:ERRor[:NEXT]?`. Each call of `SYSTem:ERRor[:NEXT]?` provides one entry from the error queue. If no error messages are stored, the instrument responds with 0, "No error".

For further description of the error queue and the device error codes, please refer to [Chapter 9.1, "Common setting commands"](#), on page 133.

9 Remote control commands

This chapter provides the description of all remote commands available for the R&S NGC100 series. The commands are sorted according to the menu structure of the instrument. A list of commands in alphabetical order is given in the "List of Command"s at the end of this documentation.

For more information on [Messages and SCPI command structure](#), see the "Annex" at the end of this documentation.

9.1 Common setting commands

Common commands are described in the IEEE 488.2 (IEC 625-2) standard. These commands have the same effect and are employed in the same way on different devices. The headers of these commands consist of "*" followed by three letters.

Many common commands are related to the Status Reporting System.

*CLS.....	133
*ESE.....	133
*ESR?.....	134
*IDN?.....	134
*OPC.....	134
*RST.....	134
*SRE.....	135
*STB?.....	135
*TST?.....	135
*WAI.....	135
*SAV.....	135
*RCL.....	136

*CLS

Clear status

Sets the status byte (STB), the standard event register (ESR) and the `EVENT` part of the `QUESTIONABLE` and the `OPERATION` registers to zero. The command does not alter the mask and transition parts of the registers. It clears the output buffer.

Usage: Setting only

*ESE <Value>

Event status enable

Sets the event status enable register to the specified value. The query returns the contents of the event status enable register in decimal form.

Parameters:

<Value> Range: 0 to 255

***ESR?**

Event status read

Returns the contents of the event status register in decimal form and then sets the register to zero.

Return values:

<Contents> Range: 0 to 255

Usage: Query only

***IDN?**

Identification

Returns the instrument identification.

Return values:

<ID> "Rohde&Schwarz,<device type>,<part number>,<serial number>,<firmware version>"

Example: Rohde&Schwarz,NGC103,3657.2413.03/041078975,00.002

Manual operation: See "[Device Information](#)" on page 103

***OPC**

Operation complete

Sets bit 0 in the event status register when all preceding commands have been executed. This bit can be used to initiate a service request. The query writes a "1" into the output buffer when all preceding commands have been executed, which is useful for command synchronization.

The R&S NGC100 does not support parallel processing of remote commands. If the query *OPC? returns a „1“, the device is able to process new commands.

***RST**

Reset

Sets the instrument to a defined default status. The default settings are indicated in the description of commands.

We recommend to start a program by *RST in order to set the instrument to a defined status prior to starting a program.

Usage: Setting only

Manual operation: See "[Default Settings](#)" on page 97
See "[Default Settings](#)" on page 111
See "[Reset](#)" on page 117

***SRE** <Contents>

Service request enable

Sets the service request enable register to the indicated value. This command determines the condition that a service request is triggered. The query `*SRE?` returns a decimal value of the service request enable register which corresponds to the binary-weighted sum of all bits.

The SRE is an enable register. Consequently, there are no denotations about the bits. This register conduces for the "OR" combination of the bits in the status byte.

Parameters:

<Contents> Contents of the service request enable register in decimal form.
 Bit 6 (MSS mask bit) is always 0.
 Range: 0 to 255

***STB?**

Status byte query

Reads the contents of the status byte in decimal form.

Usage: Query only

***TST?**

Self-test query

Initiates self-tests of the instrument and returns an error code.

Return values:

<ErrorCode> **integer > 0 (in decimal format)**
 An error occurred.
 0
 No errors occurred.

Usage: Query only

***WAI**

Wait to continue

Prevents servicing of the subsequent commands until all preceding commands have been executed and all signals have settled (see also command synchronization and [*OPC](#)).

Usage: Event

***SAV** <Number>

Save

Stores the current instrument settings under the specified number in an internal memory. The settings can be recalled using the command `*RCL` with the associated number.

Parameters:

<Number> Range: 0..9

Manual operation: See "SAVE" on page 96

`*RCL` <Number>

Recall

Loads the instrument settings from an internal memory identified by the specified number. The instrument settings can be stored to this memory using the command `*SAV` with the associated number.

Parameters:

<Number> Range: 0..9

Manual operation: See "LOAD" on page 97

9.2 System commands

The `SYSTEM` subsystem contains the commands for general functions which do not directly affect instrument operation.

Example: General instrument settings

The example represents the remote control commands for general settings.

```
// Set the sound functionality of the beeper.
//Enable the sound to beep when an error occurs
SYST:BEEP:STAT On
SYST:BEEP:STATe?
// response: 1

// Disable the sound to beep when the instrument receives a remote control command.
SYST:BEEP Off
SYST:BEEP?
// response: 0
```

<code>SYSTEM:BEEPer:STATe</code>	137
<code>SYSTEM:BEEPer[:IMMediate]</code>	137
<code>SYSTEM:ERRor[:NEXT]?</code>	137
<code>SYSTEM:LOCal</code>	137
<code>SYSTEM:RWLock</code>	138
<code>SYSTEM:REMote</code>	138
<code>SYSTEM:VERSion?</code>	138

SYSTem:BEEPer:STATe <Mode>**SYSTem:BEEPer:STATe?**

Sets or queries the front panel control beeper tone.

Parameters:

<Mode> **1**
Control beeper is activated.

0
Control beeper is deactivated.

Example: SYSTem:BEEPer:STATe 1
The front panel control beeper is activated.

Example: SYSTem:BEEPer:STATe?
Queries the state of the front panel control beeper. Returns "0" for deactivated (OFF) and "1" for activated (ON) control beeper.

SYSTem:BEEPer[:IMMEDIATE]

The instrument returns a single beep immediately.

Usage: Setting only

SYSTem:ERRor[:NEXT]?

Queries an error and removes it from the queue. Positive error numbers are instrument dependent. Negative error numbers are reserved by the SCPI standard. If the queue is empty the response is 0, "No error".

Return values:

<ERRor> 0, "No error"
 -100, "Command error"
 -102, "Syntax error"
 -221, "Settings conflict"
 -350, "Queue overflow"

Usage: Query only

SYSTem:LOCal

This command sets the system to front panel control. The front panel control is unlocked. If the front panel control was locked with the SCPI command `SYSTem:RWLock`, the message box of the locked front panel on the NGC display will be disappeared.

Usage: Setting only

SYSTem:RWLock

This command sets the system to remote state. The front panel control is locked and a message box is shown on the R&S NGC100 display. You are only able to unlock the front panel control via SCPI command [SYSTem:LOCa1](#) on page 137.

Usage: Setting only

SYSTem:REMOte

Sets the system to remote state. The front panel control is locked. By pushing the soft-key button UNLOCK KEYS the front panel control will be activated.

Usage: Setting only

SYSTem:VERSion?

Returns the firmware version and the version of the SCPI (= Standard Commands for Programmable Instruments) standard.

Usage: Query only

Manual operation: See "[Device Information](#)" on page 103

9.3 Display commands

The `DISPlay` subsystem contains the commands for configuring the front display.

Example: DISPlay settings

The example represents the remote control commands for configuring the front display.

```
*****
// Display a text message box on the front display.
// Clear the text message box on the front display.
*****
DISPlay:TEXT 'NGC103 TEST'
// response: 'NGC103 TEST' shown on the front display
DISPlay:TEXT:CLEAr
```

DISPlay:TEXT:CLEAr

Clears the text message box on the front display.

Example: See [Example"DISPlay settings"](#) on page 138.

Usage: Setting only

DISPlay:TEXT[:DATA] <String>

Displays a text message box on the front display.

Example: DISP:TEXT 'NGC103 TEST'
See also [Example"DISPlay settings"](#) on page 138.

9.4 Trigger commands

The TRIGger subsystem contains the commands for configuring the trigger signal.

Example: TRIGger settings

The example represents the remote control commands for configuring the trigger signal.

```
*****
// Set slope type for trigger signal
// Query the slope type of the trigger signal.
*****
TRIGger:SLOPe POS
TRIGger:SLOPe?
// response: POS
```

TRIGger:SLOPe <POS | NEG >

TRIGger:SLOPe?

Sets or queries the slope type of the trigger signal.

Parameters:

<POS NEG>	POSitive Rising edge.
	NEGative Falling edge.

Example: See [Example"DISPlay settings"](#) on page 138.

Manual operation: See ["EXT. TRIG"](#) on page 71

9.5 Configuration commands

The following subsystems contain the commands for channel selection, voltage and current settings for the instrument.

9.5.1 Channel selecting

The INSTRument:Select subsystem contains the commands for selecting the output channels.

Each channel of the power supply is considered as separate "instrument", which is required by the SCPI standard. Therefore, the SCPI commands use the `INSTRument` node to select a channel.



You can only address the number of channels a device is equipped with, e.g. two channels for the R&S NGC102(-G) and three channels for the R&S NGC103(-G).

Example: Selecting a channel

You can select a channel either with an `OUTput` parameter, or just by the channel number. This example lists all ways how you can select and query a selected channel.

```
// *****
// Select a channel
// *****
// selects channel 1
INST OUT1
// queries the channel selection
INST?
// response: "OUTPut1"
// *****
// Select a channel by its number
// *****
// selects channel number 1
INST:NSEL 1
// queries number of the channel selection
INST:NSEL?
// response: 1
```

INSTrument:NSElect	140
INSTrument[:SElect]	141

INSTrument:NSElect <1 | 2 | 3>

INSTrument:NSElect?

Sets or queries numerical selection of a channel. Each channel of the power supply is considered as separate "instrument", which is required by the SCPI standard.

Parameters:

1 2 3	1 Channel 1 (CH1).
	2 Channel 2 (CH2).
	3 Channel 3 (CH3).

Example: See [Example "Selecting a channel"](#) on page 140.

Options: `INSTrument:NSElect 3` not supported for R&S NGC102(-G).
This command is not supported for R&S NGC101(-G).

Manual operation: See "[\[CH1\] / \[CH2\] / \[CH3\]](#)" on page 47

INSTRument[:SElect] <arg0>

INSTRument[:SElect]?

Sets or queries a channel. Each channel of the power supply is considered as separate „instrument“, which is required by the SCPI standard.

Parameters:

<arg0> OUTPut1 | OUTPut2 | OUTPut3 | OUTP1 | OUTP2 | OUTP3

OUTPut1, OUTP1

Channel 1 (CH1).

OUTPut2, OUTP2

Channel 2 (CH2).

OUTPut3, OUTP3

Channel 3 (CH3).

Example: See [Example"Selecting a channel"](#) on page 140.

Options: OUTPut3, OUT3 not supported for R&S NGC102(-G).
This command is not supported for R&S NGC101(-G).

Manual operation: See "[\[CH1\] / \[CH2\] / \[CH3\]](#)" on page 47

9.5.2 Voltage setting

The `SOURCE:VOLTage` subsystem contains the commands for setting the voltage of the output channel. The default unit is V.

Example: Configuring the output voltage

This example contains all commands to configure and query the output voltage.

```
// *****
// Select the channel
// *****
INST OUT1
// *****
// Set the voltage value
// *****
// selects a channel and sets the voltage
VOLT 10
// queries the output voltage of a channel
VOLT?
// response: 10.000
// sets the voltage to maximum or minimum respectively
VOLT MAX
VOLT MIN
// *****
// Query the range of the voltage values
// *****
// queries the upper and lower limit of the output voltage
VOLT? MIN
// response: 0.000
VOLT? MAX
// response: 32.20
// *****
// UP/Down the voltage values, define voltage step size
// *****
VOLT 1
// define voltage step size
VOLT:STEP 4
VOLT:STEP?
//response: 4.000E+00
VOLT UP
VOLT?
//response: 5.000E+00
```

[SOURce:]VOLTage[:LEVel][:IMMediate][:AMPLitude].....	142
[SOURce:]VOLTage[:LEVel][:IMMediate][:AMPLitude] {UP DOWN}.....	143
[SOURce:]VOLTage[:LEVel][:INCRement].....	143

[SOURce:]VOLTage[:LEVel][:IMMediate][:AMPLitude] {<Voltage> | MIN | MAX}
[SOURce:]VOLTage[:LEVel][:IMMediate][:AMPLitude]? {MIN | MAX}

Sets or queries the voltage value of the selected channel.

Parameters:

<Voltage> <Voltage> | MINimum | MAXimum
 <Voltage>
 0.0 V to 32.050 V (adjustable in 1 mV steps)

MINimum
0.000E+00

MAXimum
3.2050E+01

Example: See [Example"Configuring the output voltage"](#) on page 142.

Manual operation: See ["Voltage"](#) on page 47
See ["\[3.3V\] / \[5V\] / \[12V\]"](#) on page 48
See ["Voltage / Current"](#) on page 55

[SOURce:]VOLTage[:LEVel][:IMMediate][:AMPLitude] {UP | DOWN}

Increases resp. decreases the voltage value of the selected channel. The voltage step size is defined with the VOLT:STEP command.

Parameters:

UP | DOWN

UP

The voltage value is increased.

DOWN

The voltage value is decreased.

Example: See [Example"Configuring the output voltage"](#) on page 142.

Manual operation: See ["Voltage / Current"](#) on page 55

[SOURce:]VOLTage[:LEVel][:INCRement] {<Numeric value> | DEFault}
[SOURce:]VOLTage[:LEVel][:INCRement]? [DEFault]

Sets or queries the voltage step size for the VOLT UP (VOLT DOWN) command.

Parameters:

<Numeric value> |

<Numeric value>

DEFault

0.000E+00 to 3.2050E+01 (adjustable in 1 mV steps)

*RST: 1.000E+00

Example: See [Example"Configuring the output voltage"](#) on page 142.

Manual operation: See ["Voltage / Current"](#) on page 55

9.5.3 Current setting

The `SOURce:CURRent` subsystem contains the commands for setting the current limit of the output channel. The default unit is A.

Example: Configuring the current output

```
// *****
// Select the channel
// *****
INST OUT1
// *****
// Set the current value
// *****
// selects a channel and sets the current
CURR 2
// queries the current of the selected channel
CURR?
// response: 2.000
// *****
// Query the range of the current values
// *****
// queries the upper and lower limit of the current
CURR? MIN
// response: 0.003
CURR? MAX
// response: 3.025
// *****
// UP/Down the current values, define current step size
// *****
// set current to 1 A
CURR 1
// define current step size
CURR:STEP 2
CURR: 2.000E+00
CURR UP
CURR?
//response: 3.000E+00
//combine set voltage and current of 6 V, 2 A
APPLY 6, 2
APPLY?
//response: e.g. R&S NGC103: 6.000E+00, 2.000E+00
```

[SOURce:]CURRent[:LEVel][:IMMediate][:AMPLitude].....	144
[SOURce:]CURRent[:LEVel][:IMMediate][:AMPLitude] {UP DOWN}.....	145
[SOURce:]CURRent[:LEVel][:INCRement].....	145

[SOURce:]CURRent[:LEVel][:IMMediate][:AMPLitude] {<Current> | MIN | MAX}
[SOURce:]CURRent[:LEVel][:IMMediate][:AMPLitude]? {MIN | MAX}

Sets or queries the current value of the selected channel.

Parameters:

<Current> <Current> | MINimum | MAXimum

<Current>

Current value depending on the instrument type.
Adjustable in 0.1 mA ($1 < 1 \text{ A}$) / 1 mA ($1 \geq 1 \text{ A}$) steps.

MINimum

0.5 mA

MAXimum

10 A for R&S NGC101(-G)

5 A for R&S NGC102(-G)

3 A for R&S NGC103(-G)

Example: See [Example"Configuring the current output"](#) on page 144.

Manual operation: See ["Current"](#) on page 47
See ["Voltage / Current"](#) on page 55

[SOURce:]CURRENT[:LEVel][:IMMediate][:AMPLitude] {UP | DOWN}

Increases resp. decreases the current value of the selected channel. The current step size is defined with the CURR:STEP command.

Parameters:

UP | DOWN

UP

The current value is increased.

DOWN

The current value is decreased.

Example: See [Example"Configuring the current output"](#) on page 144.

Manual operation: See ["Voltage / Current"](#) on page 55

[SOURce:]CURRENT[:LEVel][:INCRement] {<Numeric value> | DEFault}**[SOURce:]CURRENT[:LEVel][:INCRement]? [DEFault]**

Sets or queries the current step size for the CURR UP (VOLT DOWN) command.

Parameters:

<Level>

<Numeric value> | DEFault

<Numeric value>

Current value depending on the instrument type.

Adjustable in 0.1 mA ($1 < 1 \text{ A}$) / 1 mA ($1 \geq 1 \text{ A}$) steps.

10 A for R&S NGC101(-G)

5 A for R&S NGC102(-G)

3 A for R&S NGC103(-G)

DEF

1.0000E-01

*RST: 1.000E-01

Example: See [Example"Configuring the current output"](#) on page 144.

Manual operation: See ["Voltage / Current"](#) on page 55

9.5.4 Combined voltage and current settings

The `APPLY` subsystem provides a command that enables you to set the current and voltage of a channel in one step.

```
APPLY {<Voltage> | DEF | MIN | MAX} [, {<Current> | DEF | MIN | MAX}] [, {OUT1 |
      OUT2 | OUT3}]
```

APPLY?

Sets or queries the voltage and current value of the selected channel.

The execution of the `APPLY` command needs more time (approx. 100 ms) than a single instrument setting command (e.g. `INST OUT1`).

Parameters:

<code><Voltage></code>	MIN: 0.000E+00 MAX: 3.2050E+01 DEF: 1.000E+00
<code><Current></code>	Current value depending on the instrument type. MIN: 5.0000E-04 MAX: 3.000E+00 (R&S NGC103(-G)), 5.000E+00 (R&S NGC102(-G)), 10.000E+00 (R&S NGC101(-G)) DEF: 1.000E-01

Example:

```
INST OUT1
APPLY 6,2
Channel is set to 6 V and 2 A.
APPL?
Response: 6.000E+00, 2.0000E+00
```

Example: See [Example "Configuring the current output"](#) on page 144.

Manual operation: See ["Voltage"](#) on page 47
See ["Current"](#) on page 47
See ["\[3.3V\] / \[5V\] / \[12V\]"](#) on page 48
See ["Voltage / Current"](#) on page 55

9.5.5 Output setting

The `OUTPUT` subsystem contains the commands for activating the output channels.

Example: Activating the channels

You can activate a selected channel and turn on or off the outputs either individually or all outputs simultaneously. This example lists all ways how you can activate and query the outputs.

```
// *****
// Activate a channel
// *****
INST OUT1
//channel CH1 output is activated, CH1 ON/OFF LED lights up
OUTP:CHAN ON
// activates the selected channel, channel CH1 output and master output is activated;
// CH1 ON/OFF and MASTER ON/OFF LED will light up
OUTP ON
// queries the output state
OUTP?
// response: 1
// *****
// Turn on all selected channels simultaneously
// *****
// selects channels 1 and 2
// sets the voltage and current values for both channels
// activates both channels
INST:OUT1
VOLT 6
CURR 0.1
//CH1 ON/OFF LED lights up.
OUTP ON
INST:OUT2
VOLT 12
CURR 0.2
//CH2 ON/OFF LED lights up.
OUTP ON
// Turns on the msater output of both channels, all previous activated channels will be
activated simultaneously. The MASTER ON/OFF LED lights up.
OUTP:MAST ON
```

OUTPut:CHANnel[:STATe].....	147
OUTPut:MASTer[:STATe].....	148
OUTPut[:STATe].....	148

OUTPut:CHANnel[:STATe] {OFF | ON | 0 |1}
OUTPut:CHANnel[:STATe]?

Sets or queries the previous selected channel. The channel output LED lights up.

Parameters:

OFF ON 0 1	ON 1 Channel output is activated.
	OFF 0 Channel output is deactivated.

*RST: OFF | 0

- Example:** See [Example"Activating the channels"](#) on page 147.
- Options:** The command is not supported for R&S NGC101(-G).
- Manual operation:** See "[\[CH1 On/Off\] / \[CH2 On/Off\] / \[CH3 On/Off\]](#)" on page 48
See "[\[Master On/Off\] / \[Output On/Off\]](#)" on page 56

OUTPut:MASTer[:STATe] {OFF | ON | 0 |1}

OUTPut:MASTer[:STATe]?

Sets or queries all previous selected channels simultaneously.

Parameters:

OFF | ON | 0 |1

ON |1

Master output is activated.

OFF | 0

Master output is deactivated.

*RST: OFF | 0

- Example:** See [Example"Activating the channels"](#) on page 147.

Options: The command is not supported for R&S NGC101(-G).

- Manual operation:** See "[\[Master On/Off\]](#)" on page 49
See "[\[Master On/Off\] / \[Output On/Off\]](#)" on page 56

OUTPut[:STATe] {OFF | ON | 0 |1}

OUTPut[:STATe]?

Sets or queries the previous selected channel and turning on the master output. The selected channel and master output LED lights up. If the output is turned off with `OUTP OFF` only the previous selected channel is deactivated. After sending `OUTP OFF` command the master output button is still activated.

Parameters:

OFF | ON | 0 |1

ON |1

Channel and master output is activated.

OFF | 0

Channel is deactivated.

*RST: OFF | 0

- Example:** See [Example"Activating the channels"](#) on page 147.

Manual operation: See "[\[Master On/Off\] / \[Output On/Off\]](#)" on page 56

9.5.6 Fuse setting

The `FUSE` subsystem contains the commands for overcurrent protection parameters such as activating fuses and setting fuse parameters of the output channels. The default unit is A.

Example: Configuring fuses

This example contains all commands to configure and query the fuse states and settings.

```
// *****
// Activate a fuse
// *****
INST OUT1
// selects a channel and activates the overcurrent protection
FUSE 1
// queries the state of the overcurrent protection in the selected channel
FUSE?
// response: 1
// *****
// Set a delay time for the overcurrent protection. The delay time
// takes effect when the channel output is turned on.
// *****
// sets 0.05 s delay for the overcurrent protection
FUSE:DEL 0.05
// queries the currently set delay time of the overcurrent protection
// in the selected channel
FUSE:DEL?
// response: 0.05
// sets the delay time to maximum, minimum respectively
FUSE:DEL MAX
FUSE:DEL MIN
// *****
// Query the range of the overcurrent protection delay time
// *****
// queries the upper and lower limit of the
// overcurrent protection delay time in s
FUSE:DEL? MIN
// response: 0
FUSE:DEL? MAX
// response: 10
// *****
// Query a tripped overcurrent protection
// *****
INST OUT1
//queries whether the OCP in channel 1 has tripped
FUSE:TRIP?
//response: 1 OCP is tripped
//response: 0 OCP is not tripped
// *****
// Link the electronic overcurrent protection of the channels logically
// *****
INST OUT1
// links the overcurrent protection of channel 1 with channel 2
FUSE:LINK 2
// queries the combined overcurrent protection of the selected channel
```

```

FUSE:LINK? 2
// response 1
// *****
// Unlink linked overcurrent protection
// *****
FUSE:UNLink 2
// queries the combined overcurrent protection of the selected channel
FUSE:LINK? 2
// response 0

```

FUSE:DElay.....	150
FUSE:LINK.....	150
FUSE:TRIPed?.....	151
FUSE:UNLink {1 2 3}.....	151
FUSE[:STATe].....	151

FUSE:DElay {<Delay> | MIN | MAX}

FUSE:DElay? [MIN | MAX]

Sets or queries a fuse delay for the previous selected channel.

Parameters:

<Delay> | MIN | MAX **<Delay>**
 10 ms to 10 s (adjustable in 1 ms steps)

MIN
 1.000E-02.

MAX
 1.000E+01

Example: See [Example"Configuring fuses"](#) on page 149.

Manual operation: See ["DELAY"](#) on page 59

FUSE:LINK {1 | 2 | 3}

FUSE:LINK?

Combines or queries the channel fuses (fuse linking) for the previous selected channel. Each channel fuse can be linked together (depending on the instrument type).

Parameters:

1 | 2 | 3 **1**
 Channel CH1.

2
 Channel CH2.

3
 Channel CH3.

Example: See [Example"Configuring fuses"](#) on page 149.

Options: Channel 3 (CH3) is not available for R&S NGC102(-G).
 This command is not supported for R&S NGC101(-G).

Manual operation: See ["LINKED TO"](#) on page 59

FUSE:TRIPed?

Queries the fuse trip of the previous selected channel.

Return values:

<state> 1: Fuse is tripped.
 0: Fuse is not tripped.

Example: See [Example"Configuring fuses"](#) on page 149.

Usage: Query only

Manual operation: See ["ACTIVATE"](#) on page 58

FUSE:UNLink {1 | 2 | 3}

Unlinks the channel fuses (fuse linking).

Parameters:

1 | 2 | 3 **1**
 Channel CH1.
 2
 Channel CH2.
 3
 Channel CH3.

Example: See [Example"Configuring fuses"](#) on page 149.

Usage: Setting only

Options: Channel 3 (CH3) is not available for R&S NGC102(-G).
 The FUSE:UNLINK command is not supported for
 R&S NGC101(-G).

Manual operation: See ["LINKED TO"](#) on page 59

FUSE[:STATe] {OFF | ON | 0 | 1}

FUSE[:STATe]?

Sets or queries the fuse for the previous selected channel.

Parameters:

OFF | ON | 0 | 1 **ON | 1**
 Fuse is activated.
 OFF | 0
 Fuse is deactivated.
 *RST: OFF | 0

Example: See [Example"Configuring fuses"](#) on page 149.

Manual operation: See "FUSE" on page 47
See "ACTIVATE" on page 58

9.5.7 OVP setting

The `VOLTage:PROTection` subsystem contains the commands for setting the over-voltage protection parameters for the output channels. The default unit is V.

Example: Configuring the overvoltage protection

```

// *****
// Set the overvoltage protection value
// *****
INST OUT1
//activates the OVP of the previous selected channel
VOLT:PROT 1
// selects a channel and sets the OVP
VOLT:PROT:LEV 5
// queries the output overvoltage value of a channel
VOLT:PROT:LEV?
// response: 5
// queries the OVP state of the previous selected channel
VOLT:PROT?
// response: 1
// sets the overvoltage protection to maximum,
// or minimum respectively
VOLT:PROT:LEV MAX
VOLT:PROT:LEV MIN
// *****
// Query the range of the overvoltage protection values
// *****
// queries the upper and lower limit
VOLT:PROT:LEV? MIN
// response: 0.100
VOLT:PROT:LEV? MAX
// response: 32.2
// *****
// Query a tripped overvoltage protection
// *****
INST OUT1
// queries whether the OVP in channel 1 has tripped
VOLT:PROT:TRIP?
// response: 1 OVP is tripped
// response: 0 OVP is not tripped
// resets a tripped OVP in the selected channel
VOLT:PROT:CLEAr
// *****
// Set the overvoltage protection mode
// *****
INST OUT1
// sets OVP protected mode for channel1
VOLT:PROT:MODE PROT
// queries the OVP mode
VOLT:PROT:MODE PROT?
// response: "protected"

```

[SOURce:]VOLTage:PROTection:CLEAr.....	154
[SOURce:]VOLTage:PROTection:LEVel.....	154
[SOURce:]VOLTage:PROTection:MODE.....	154
[SOURce:]VOLTage:PROTection:TRIPped?.....	155
[SOURce:]VOLTage:PROTection[:STATe].....	155

[SOURce:]VOLTage:PROTection:CLEAr

Resets the OVP state of the selected channel. If the OVP has tripped, the OVP message on the display is cleared for the selected channel.

Example: See [Example"Configuring the overvoltage protection"](#) on page 153.

[SOURce:]VOLTage:PROTection:LEVel {<Voltage> | MIN | MAX | DEF} [SOURce:]VOLTage:PROTection:LEVel? [MIN | MAX | DEF]

Sets or queries OVP value of the previous selected channel.

Parameters:

<Level> <Voltage> | MIN | MAX | DEF

<Voltage>
0 V to 32.50 V (adjustable in 1 mV steps).

MIN
0.000E+00

MAX
3.2050E+01

DEF
3.2050E+01

Example: See [Example"Configuring the overvoltage protection"](#) on page 153.

Manual operation: See ["LEVEL"](#) on page 64

[SOURce:]VOLTage:PROTection:MODE {MEASured | PROTectioned} [SOURce:]VOLTage:PROTection:MODE?

Sets or queries the OVP mode for the previous selected channel.

Parameters:

<Mode> MEASured | PROTectioned

MEASured
The OVP switches off if the measured value exceeds the threshold.

PROTectioned
If the adjusted threshold is exceeded, the output of the instrument is not switched on; additionally the measured value is monitored (please also refer to function "MEASured").

Example: See [Example"Configuring the overvoltage protection"](#) on page 153.

Manual operation: See ["MODE"](#) on page 64

[SOURce:]VOLTage:PROTection:TRIPped?

Queries the OVP state of the previous selected channel.

Return values:

<state> 1: OVP is tripped.
 0: OVP is not tripped.

Example: See [Example"Configuring the overvoltage protection"](#) on page 153.

Usage: Query only

Manual operation: See ["ACTIVATE"](#) on page 64

[SOURce:]VOLTage:PROTection[:STATe] {OFF | ON | 0 | 1} [SOURce:]VOLTage:PROTection[:STATe]?

Sets or queries the OVP for the previous selected channel.

Parameters:

OFF | ON | 0 | 1 **ON | 1**
 OVP is activated.
 OFF | 0
 OVP is not deactivated.
 *RST: OFF | 0

Example: See [Example"Configuring the overvoltage protection"](#) on page 153.

Manual operation: See ["OVP / OPP"](#) on page 47
 See ["ACTIVATE"](#) on page 64

9.5.8 OPP setting

The POWer:PROTection subsystem contains the commands for setting the over-power protection parameters for the output channels. The default unit is W.

Example: Configuring the overpower protection

```
// *****
// Set the overpower protection value
// *****
INST OUT1
//activates the OPP of the previous selected channel
POW:PROT 1
// selects a channel and sets the OPP
POW:PROT:LEV 5
// queries the output overvoltage value of a channel
POW:PROT:LEV?
// response: 5
// queries the OPP state of the previous selected channel
POW:PROT?
// response: 1
// sets the overvoltage protection to maximum,
// or minimum respectively
POW:PROT:LEV MAX
POW:PROT:LEV MIN
// *****
// Query the range of the overpower protection values
// *****
// queries the upper and lower limit
POW:PROT:LEV? MIN
// reponse: 0.0
POW:PROT:LEV? MAX
// reponse: 32.0
// *****
// Query a tripped overpower protection
// *****
INST OUT1
// queries whether the OPP in channel 1 has tripped
POW:PROT:TRIP?
// response: 1 OPP is tripped
// response: 0 OPP is not tripped
// resets a tripped OPP in the selected channel
POW:PROT:CLEAr
```

[SOURCE:]POWER:PROTECTION:CLEAR.....	156
[SOURCE:]POWER:PROTECTION:LEVEL.....	157
[SOURCE:]POWER:PROTECTION:TRIPPED?.....	157
[SOURCE:]POWER:PROTECTION[:STATE].....	157

[SOURCE:]POWER:PROTECTION:CLEAR

Resets the OPP state of the selected channel. If the OPP has tripped, the red blinking OPP message on the display is cleared for the selected channel.

Example: See [Example"Configuring the overpower protection"](#) on page 156.

Manual operation: See ["ACTIVATE"](#) on page 64
See ["ACTIVATE"](#) on page 64

[SOURCE:]POWER:PROTECTION:LEVEL {<Voltage> | MIN | MAX | DEF}
[SOURCE:]POWER:PROTECTION:LEVEL? [MIN | MAX | DEF]

Sets or queries OPP value of the previous selected channel.

Parameters:

<Level> <Voltage> | MIN | MAX | DEF

<Voltage>
0 W to 33 W (adjustable in 10 mW steps).

MIN
0.000E+00

MAX
3.300E+01

DEF
3.300E+01

Example: See [Example"Configuring the overpower protection"](#) on page 156.

Manual operation: See ["LEVEL"](#) on page 64

[SOURCE:]POWER:PROTECTION:TRIPPED?

Queries the OPP state of the previous selected channel.

Return values:

<state> 1: OPP is tripped.
0: OPP is not tripped.

Example: See [Example"Configuring the overpower protection"](#) on page 156.

Usage: Query only

Manual operation: See ["ACTIVATE"](#) on page 64

[SOURCE:]POWER:PROTECTION[:STATE] {OFF | ON | 0 | 1}
[SOURCE:]POWER:PROTECTION[:STATE]?

Sets or queries the OPP for the previous selected channel.

Parameters:

OFF | ON | 0 | 1

ON | 1
OPP is activated.

OFF | 0
OPP is not deactivated.

*RST: OFF | 0

- Example:** See [Example"Configuring the overpower protection"](#) on page 156.
- Manual operation:** See ["OVP / OPP"](#) on page 47
See ["ACTIVATE"](#) on page 64

9.6 Measurement commands

The MEASure subsystem provides commands to query the voltage and current values of a channel.

MEASure[:SCALar]:CURRent[:DC]?.....	158
MEASure[:SCALar]:ENERgy?.....	158
MEASure[:SCALar]:ENERgy:STATe.....	158
MEASure[:SCALar]:ENERgy:RESet.....	159
MEASure[:SCALar]:POWer[:DC]?.....	159
MEASure[:SCALar]:VOLTage[:DC]?.....	159

MEASure[:SCALar]:CURRent[:DC]?

Queries the measured current value of the previous selected channel.

- Example:** MEAS:CURR? -> e.g. 1.000E+00
- Usage:** Query only
- Manual operation:** See ["HOLD"](#) on page 74

MEASure[:SCALar]:ENERgy?

Queries the measured the current released energy value of the previous selected channel. Please notice that the energy meter has to be activated to measure the current released energy value.

- Example:** MEAS:ENER? -> e.g. 5.382E+00 (value in Ws)
- Usage:** Query only
- Manual operation:** See ["HOLD"](#) on page 74

MEASure[:SCALar]:ENERgy:STATe {OFF | ON | 0 | 1} MEASure[:SCALar]:ENERgy:STATe?

Sets or queries the energy meter function.

- Parameters:**
- | | |
|------------------|--|
| OFF ON 0 1 | ON 1
Energy meter is activated. |
| | OFF 0
Energy meter is not deactivated. |
| *RST: | OFF 0 |

Example: `MEAS:ENER:STAT ON`
Activates the energy meter function.

Manual operation: See "[ACTIVATE](#)" on page 74

MEASure[:SCALar]:ENERgy:RESet

Resets the energy meter value of the previous selected channel.

Usage: Setting only

Manual operation: See "[Clear](#)" on page 75

MEASure[:SCALar]:POWER[:DC]?

Queries the measured power value of the previous selected channel.

Example: `MEAS:POW?` -> e.g. 3.00E+00

Usage: Query only

Manual operation: See "[HOLD](#)" on page 74

MEASure[:SCALar]:VOLTage[:DC]?

Queries the measured voltage value of the previous selected channel.

Example: `MEAS:VOLT?` -> e.g. 1.000E+00

Usage: Query only

Manual operation: See "[HOLD](#)" on page 74

9.7 Advanced operating commands

The following shows the subsystem that contains the commands for configuring the arbitrary function, EasyRamp and Digital I/O functions.

9.7.1 Arbitrary commands

The `ARBitrary` subsystem contains the commands for configuring an arbitrary sequence for the output channels.

Example: Configuring an arbitrary sequence

This programming example generates an arbitrary sequence for a selected channel. The sequence starts at 1 V and 1 A for 1 sec, and both values are incremented each second by 1. The generated arbitrary waveform is transferred to CH1. When activated, the R&S NGC100 provides the arbitrary waveform at the output of the selected channel, and repeats it 10 times.

```
// *****
// Define and start the EasyArb sequence
// *****
// selects channel 1
INST OUT1
// defines the sequence, i.e. starting at 1V, 1A for 1sec,
// and increments the voltage and current each second by 1
ARB:DATA "1,1,1,0,2,2,1,0,3,3,1,0"
// sets the repetition rate
ARB:REP 10
// ARB:REP? queries the set number of repetitions
// ARB:POIN? queries the number of arbitrary points of EasyArb waveform
// Enable the arbitrary sequence
ARB 1
// starts the sequence in channel 1
// ARB 0 stops the sequence in the selected channel
// turns on the output
OUTP ON
// *****
// Save and recall an arbitrary sequence
// *****
// defines the file name and storage location (internal memory) for the arbitrary function
ARB:FNAM "ARB01.CSV",INT
// saves the sequence into the internal memory
ARB:SAV
// loads a previously saved sequence from the internal memory
ARB:LOAD
//Activates arbitrary trigger
ARB:TRIG ON
//Set triggered mode
ARB:TRIG:MODE SIN

// clears the arbitrary table data for the selected channel
ARB:CLEAR
```

ARbitrary:BEHavior:END.....	161
ARbitrary:CLEar.....	161
ARbitrary:ENDPoint.....	161
ARbitrary:FNAME.....	162
ARbitrary:LOAD.....	162
ARbitrary:REPetitions.....	162
ARbitrary:SAVE.....	162
ARbitrary:TRIGgered:MODE.....	163

ARbitrary:TRIGgered[:STATe].....	163
ARbitrary[:STATe].....	164
ARbitrary:DATA.....	164

ARbitrary:BEHavior:END {OFF | HOLD} **ARbitrary:BEHavior:END?**

Sets or queries the arbitrary endpoint behavior, when arbitrary function is finished.

Parameters:

OFF | HOLD

OFF

If the arbitrary function is finished, the respective channel is deactivated automatically.

HOLD

If the arbitrary function is finished, the last arbitrary point of the user-defined arbitrary list is held.

Example: See [Example"Configuring an arbitrary sequence"](#) on page 160.

Manual operation: See ["END BEHAV."](#) on page 87

ARbitrary:CLEar

Clears the previous defined arbitrary waveform data for the selected channel.

Example: See [Example"Configuring an arbitrary sequence"](#) on page 160.

Usage: Event

Manual operation: See ["Clear All"](#) on page 91

ARbitrary:ENDPoint <ENDPoint> **ARbitrary:ENDPoint?**

Sets or queries the arbitrary waveform endpoint of the selected channel. Max. 512 arbitrary points can be defined.

Parameters:

<ENDPoint> 1 to 512 arbitrary points

Example:

```
INST OUT1
ARB:ENDP 30
ARB:ENDP? -> 30, the arbitrary waveform of channel CH1 is
repeated 30 times.
```

Example: See [Example"Configuring an arbitrary sequence"](#) on page 160.

Manual operation: See ["END POINT"](#) on page 87

ARbitrary:FNAME {<Filename>},{[INT | EXT |DEF]}

ARbitrary:FNAME?

Sets or queries the file name and storage location for the arbitrary function.

Parameters:

<Filename> e.g. "ARB01.CSV",INT

INT

Internal memory.

EXT

USB stick.

DEF

Internal memory.

Example: See [Example"Configuring an arbitrary sequence"](#) on page 160.

Manual operation: See "[FILENAME](#)" on page 89

ARbitrary:LOAD

Loads the stored arbitrary waveform of the previous selected channel and memory.

Example: See [Example"Configuring an arbitrary sequence"](#) on page 160.

Manual operation: See "[LOAD](#)" on page 90

ARbitrary:REPetitions <Repetitions>

ARbitrary:REPetitions?

Sets or queries the repetition rate of the defined arbitrary waveform for the previous selected channel. Up to 255 repetitions are possible. If the repetition rate "0" is selected, the arbitrary waveform of the previous selected channel is repeated infinitely.

Parameters:

<Repetitions> 0 to 255 repetitions

Example:

INST OUT1

ARB:REP 10

ARB:REP? > 10, the repetition rate of the CH1 arbitrary waveform is 10.

Example: See also [Example"Configuring an arbitrary sequence"](#) on page 160.

Manual operation: See "[REPETITION](#)" on page 87

ARbitrary:SAVE

Stores the previous defined arbitrary points of the selected channel to the selected memory with the defined file name.

Example:

```
INST OUT1
ARB:DATA 10,1,0.5,0
ARB:REP 10
ARB:FNAM "ARB01.CSV",INT
ARB:SAVE
```

Example: See also [Example"Configuring an arbitrary sequence"](#) on page 160.

Manual operation: See ["SAVE"](#) on page 88
See ["SAVE"](#) on page 90

ARbitrary:TRIGgered:MODE {SINGle | RUN} **ARbitrary:TRIGgered:MODE?**

Sets or queries the arbitrary trigger mode of the previous selected channel.

Parameters:

SINGle | RUN

SINGle

A trigger event starts the whole arbitrary sequence (with all repetitions).

RUN

A trigger event starts only one arbitrary sequence.

Example: See [Example"Configuring an arbitrary sequence"](#) on page 160.

Manual operation: See ["TRIG MODE"](#) on page 91

ARbitrary:TRIGgered[:STATe] {ON | OFF | 0 | 1} **ARbitrary:TRIGgered[:STATe]?**

Sets or queries the trigger input on the rear connector (terminal block) for arbitrary functionality.

Parameters:

ON | OFF | 0 | 1

ON | 1

Trigger input is activated.

OFF | 0

Trigger input is deactivated.

*RST: OFF | 0

Example:

```
INST OUT1
ARB:TRIG ON
ARB:TRIG?, > 1; Trigger input on the rear connector is activated for CH1 arbitrary waveform.
```

Manual operation: See ["TRIGGERED"](#) on page 91

ARbitrary[:STATe] {OFF | ON | 0 | 1}

ARbitrary[:STATe]?

Sets or queries the arbitrary function for the previous selected channel.

Parameters:

OFF | ON | 0 | 1

ON | 1

Arbitrary function is activated.

OFF | 0

Arbitrary function is deactivated.

*RST: OFF | 0

Manual operation: See "[E.ARB](#)" on page 47
See "[ACTIVATE](#)" on page 86

ARbitrary:DATA <Data>

ARbitrary:DATA?

Sets or queries the arbitrary points for the previous selected channel. Max. 512 arbitrary points can be defined. The dwell time between 2 arbitrary points is specified from 10 ms to 10 min.

Parameters:

<Data>

voltage1,current1,time1,interpolation mode1,voltage2,current2, ... Voltage and current setting depending on the instrument type.

Interpolation mode:

1: Y - Interpolation mode activated.

2: N - Interpolation mode disabled.

Example:

```
INST OUT1
```

```
ARB:DATA 10,1,0.5,0
```

Defines one arbitrary point with voltage1 = 10 V, current1 = 1 A, Time1 = 500 ms, Interpolation mode = 0 (disabled).

```
ARB:DATA? -> 10.000,1.000,0.50,0
```

Example:

See also [Example"Configuring an arbitrary sequence"](#) on page 160.

Manual operation: See "[SAVE](#)" on page 88
See "[LOAD](#)" on page 90

9.7.2 EasyRamp commands

The `VOTage:RAMP` subsystem contains the commands for configuring the ramp function for the output channels.

[SOURce:]VOLTage:RAMP:DURation {<Duration> | MIN | MAX | DEF}
[SOURce:]VOLTage:RAMP:DURation?

Sets or queries the duration of the voltage ramp.

Parameters:

<Duration> <Duration> | MIN | MAX | DEF

<Duration>
 10 ms to 10 s

MIN
 1.00E-02.

MAX
 1.000E+01.

DEF
 1.00E-02

Example: VOLT:RAMP:DUR? -> e.g. 4.00E+00

Manual operation: See "TIME" on page 93

[SOURce:]VOLTage:RAMP[:STATe] {OFF | ON | 0 | 1}
[SOURce:]VOLTage:RAMP[:STATe]?

Sets or queries the EasyRamp function for the previous selected channel.

Parameters:

ON | OFF | 0 | 1 **ON | 1**
 EasyRamp function is activated.

OFF | 0
 EasyRamp function is deactivated.

*RST: OFF | 0

Example: INST OUT1
 VOLT:RAMP ON
 VOLT:RAMP?, > 1; EasyRamp function of CH1 is activated.

Manual operation: See "RAMP" on page 48
 See "ACTIVATE" on page 93

9.7.3 Analog In

The [SOURce:]VOLTage:AINP subsystem contains the commands for configuring the Analog In function for the output channels.

Example: Configuring Analog In signal

```
//This example contains all commands to configure the Analog In function
// selects channel 1
INST OUT 1
//activates Analog In function
VOLT:AINP: ON
//Set input unit of Analog In to volt
VOLT:AINP:INP VOLT
//set Analog In mode to step
VOLT:AINP:MODE STEP
//set threshold level to 5 V,
//the output voltage of 0 V to 32 V is regulated with an input level of 0 - 5V
VOLT:AINP:THR 5
VOLT:AINP:THR?
//response: 5 V
```

[SOURce:]VOLTage:AINPut:MODE.....	166
[SOURce:]VOLTage:AINPut:INPut.....	166
[SOURce:]VOLTage:AINPut:THReshold.....	167
[SOURce:]VOLTage:AINPut[:STATe].....	167

[SOURce:]VOLTage:AINPut:MODE {LINear | STEP}

[SOURce:]VOLTage:AINPut:MODE?

Sets or queries the mode of the Analog In connector (terminal block) on the rear panel.

Parameters:

LINear | STEP

LINear

Output voltage linear to the input voltage.

STEP

Reference value or zero depending on threshold.

Example: See [Example"Configuring Analog In signal"](#) on page 166.

Manual operation: See ["MODE"](#) on page 67

[SOURce:]VOLTage:AINPut:INPut {VOLTage | CURRent}

[SOURce:]VOLTage:AINPut:INPut?

Sets or queries the input unit of the Analog In connector (terminal block) on the rear panel.

Example: VOLTage:AINPut:INPut? -> e.g. VOLT

Manual operation: See ["INPUT"](#) on page 67

[SOURce:]VOLTage:AINPut:THReshold {<Threshold> | MIN | MAX | DEF}
[SOURce:]VOLTage:AINPut:THReshold?

Sets or queries the threshold for the Analog In mode STEP.

Parameters:

<Input> <Threshold> | MIN | MAX | DEF
 <Threshold>
 0 V to 10 V (adjustable in 100 mV steps)
MIN
 0.0E+00
MAX
 1.000E+01
DEF
 1.00E+00

Example: See [Example"Configuring Analog In signal"](#) on page 166.

Manual operation: See ["THRESHOLD"](#) on page 67

[SOURce:]VOLTage:AINPut[:STATe] {ON | OFF | 0 | 1}
[SOURce:]VOLTage:AINPut[:STATe]?

Sets or queries the Analog In function for the previous selected channel.

Parameters:

ON | OFF | 0 | 1 **ON | 1**
 Analog In function is activated.
 OFF | 0
 Analog In function is deactivated.
 *RST: OFF | 0

Example: See [Example"Configuring Analog In signal"](#) on page 166.

Manual operation: See ["ANALOG IN"](#) on page 48
 See ["ACTIVATE"](#) on page 67

9.7.4 Sequencing

The SEQuence:CHANnel subsystem contains the commands for configuring the sequencing function for the output channels.

SEQuence:CHANnel[:STATe]	168
SEQuence:DELay	168
SEQuence:TRIGgered	168
SEQuence[:STATe]	169

SEquence:CHANnel[:STATe] {OFF | ON | 0 | 1}
SEquence:CHANnel[:STATe]?

Sets or queries the power sequencing delay of the previous selected channel.

Parameters:

ON | OFF | 0 | 1 **ON | 1**
 Sequencing delay is activated.
OFF | 0
 Sequencing delay is deactivated.
 *RST: OFF | 0

Example:

```
INST OUT1
SEQ:CHAN ON
SEQ:CHAN? -> 1; Sequencing delay for channel CH1 is activated.
```

Manual operation: See "[ACT. <channel>](#)" on page 70

SEquence:DELay {<Delay> | MIN | MAX}
SEquence:DELay?

Sets or queries the power sequencing delay of the previous selected channel.

Parameters:

<Delay> | MIN | MAX **<Delay>**
 1 ms to 60 s.
MIN
 1.000E-03
MAX
 6.0000E+01

Example: SEQ:DEL? -> e.g. 2.000E+00

Manual operation: See "[DELAY <channel>](#)" on page 70

SEquence:TRIGgered {ON | OFF | 0 | 1}
SEquence:TRIGgered?

Sets or queries the power sequencing trigger function of the previous selected channel.

Parameters:

ON | OFF | 0 | 1 **ON | 1**
 Trigger function is activated.
OFF | 0
 Trigger function is deactivated.
 *RST: OFF | 0

Example:

```
SEQ:TRIG ON
SEQ:TRIG? -> 1; Trigger function is activated.
```

Manual operation: See "TRIGGERED" on page 70

SEquence[:STATe] {OFF | ON | 0 | 1}
SEquence[:STATe]?

Sets or queries the power sequencing function state.

Parameters:

ON | OFF | 0 | 1 **ON | 1**
 Sequencing function is activated.
OFF | 0
 Sequencing function is deactivated.
 *RST: OFF | 0

Example: SEQ ON
 SEQ? -> 1; Sequencing function is activated.

Manual operation: See "ACTIVATE" on page 70

9.8 Data and file management commands

The DATA and HCOPY subsystem contains commands for managing the files in the instrument and external USB stick.

Example: Data logging on CH1 and CH2

The instrument logs the measurement values from channel CH1 and channel CH2 simultaneously in 1s steps

```
*RST
APPLY 12,1,OUT1
APPLY 18,0.1,OUT2
INST OUT1
OUTP:STAT ON
LOG:CHAN ON
INST OUT2
OUTP:STAT ON
LOG:CHAN ON
LOG:FNAM "Test.txt",EXT
LOG:FORM TXT
LOG:MODE UNL
LOG:INT 1
LOG:STAT ON
```

Example:

Saved TXT file. Take note that the correct storage space (in this case USB stick / EXT) is selected.

```
#Device;HMC8043
#Device Name;NO NAME
#Format;LOG
#Date;2020-07-27
#Version;01.300-02.420-03.720
#Serial No.;020600485
#Mode;Unlimited
#Logging Interval[s];1.000
#Specified Logging Count;-----
#Specified Logging Time[s];-----
#Sequence;Off
#CH1 Voltage Target[V];12.000
#CH1 Current Target[A];1.000
#CH1 Sequence Delay[s];-----
#CH1 EasyArb;Off
#CH1 OVP;Off
#CH1 OPP;Off
#CH1 Ramp;Off
#CH1 Analog in;Off
#CH2 Voltage Target[V];18.000
#CH2 Current Target[A];0.100
#CH2 Sequence Delay[s];-----
#CH2 EasyArb;Off
#CH2 OVP;Off
#CH2 OPP;Off
#CH2 Ramp;Off
#CH2 Analog in;Off
#Start Time;15:20:11
#Stop Time;15:20:19
#Actual Count; 5
//Saved Txt file:
U1[V];I1[A];U2[V];I2[A];Timestamp
12.000;0.0002;18.000;0.0000;15:20:11:311
12.000;0.0002;18.000;0.0000;15:20:12:310
12.000;0.0002;18.000;0.0000;15:20:13:309
12.000;0.0002;18.000;0.0000;15:20:14:308
12.000;0.0002;18.000;0.0000;15:20:15:307
```

[DATA:]LOG:CHANnel[:STATE].....	171
[DATA:]LOG:COUNT.....	171
[DATA:]LOG:FNAME.....	171
[DATA:]LOG:FORMat.....	172
[DATA:]LOG:INTerval.....	172
[DATA:]LOG:MODE.....	172
[DATA:]LOG:TIME.....	173
[DATA:]LOG:TRIGgered.....	173

[DATA:]LOG[:STATe].....	173
DATA:DATA?.....	174
DATA:DELeTe.....	174
DATA:LIST?.....	175
DATA:POINtS?.....	175
HCOPy:DATA?.....	175
HCOPy:FORMat.....	176
HCOPy:SIZE:X?.....	176
HCOPy:SIZE:Y?.....	176

[DATA:]LOG:CHANnel[:STATe] {ON | OFF | 0 | 1}

[DATA:]LOG:CHANnel[:STATe]?

Sets or queries the data logging function for the previous selected channel on or off.

Parameters:

ON | OFF | 0 | 1

ON | 1

Data logging function for the previous selected channel is activated.

OFF | 0

Data logging function for the previous selected channel is deactivated.

*RST: OFF | 0

Example: See [Example "Data logging on CH1 and CH2"](#) on page 169.

Manual operation: See ["ACTIVATE"](#) on page 78

[DATA:]LOG:COUNT <No of samples>

[DATA:]LOG:COUNT?

Sets or queries the number of measurement values to be captured.

Parameters:

<No of samples> Number of measurement values to be captured.

Example: LOG:COUNT? -> e.g. 1.00E+01

Manual operation: See ["COUNT"](#) on page 82

[DATA:]LOG:FNAME {<filename>},{[INT | EXT | DEF]}

[DATA:]LOG:FNAME?

Sets or queries the file name and storage location for the logging function.

Parameters:

<filename> e.g. "Test01.CSV",INT

INT

Internal memory.

EXT

USB stick.

DEF

Internal memory.

*RST: OFF | 0

Example: LOG:FNAM? -> "/INT/DATA/Test01.CSV"**Manual operation:** See "[FILENAME](#)" on page 80**[DATA:]LOG:FORMat {CSV | TXT}****[DATA:]LOG:FORMat?**

Sets or queries the data logging file format.

Parameters:

CSV | TXT

CSV

Comma separated values.

TXT

Text file.

*RST: CSV

Example: See [Example "Data logging on CH1 and CH2"](#) on page 169.**Manual operation:** See "[FORMAT](#)" on page 80**[DATA:]LOG:INTerval <Interval in seconds>****[DATA:]LOG:INTerval?**

Sets or queries the logging measurement interval. The measurement interval describes the time between the recorded measurements.

Parameters:

<Interval in seconds> 1 ms to 3600 s.

Example: LOG:INT? -> e.g. 1.0E+00**Manual operation:** See "[INTERVAL](#)" on page 78**[DATA:]LOG:MODE {UNLimited | COUNT | TIME}****[DATA:]LOG:MODE?**

Sets or queries the data logging mode.

Parameters:

<Mode>

UNLimited | COUNT | TIME

UNLimited

Infinite data capture.

COUNT

Number of measurement values to be captured.

TIME

Duration of the measurement values capture.

*RST: UNL

Example: See [Example "Data logging on CH1 and CH2"](#) on page 169.

Manual operation: See ["MODE"](#) on page 82

[DATA:]LOG:TIME <Time in seconds>
[DATA:]LOG:TIME?

Sets or queries the data logging time.

Parameters:

<Time in seconds> Depending on instrument settings.

Example: LOG:MODE? -> e.g. 5.00000E+04

Manual operation: See ["TIME"](#) on page 81

[DATA:]LOG:TRIGgered {ON | OFF | 0 | 1}
[DATA:]LOG:TRIGgered?

Sets or queries the manual trigger for the data logging function on or off. The TRIG button is illuminated.

Parameters:

ON | OFF | 0 | 1 **ON | 1**
 Manual trigger function is activated.
OFF | 0
 Manual trigger function is deactivated.
 *RST: OFF | 0

Example: LOG:TRIG ON
 LOG:TRIG? -> 1

Manual operation: See ["TRIGGERED"](#) on page 82

[DATA:]LOG[:STATe] {OFF | ON | 0 | 1}
[DATA:]LOG[:STATe]?

Sets or queries the data logging function on or off.

Parameters:

ON | OFF | 0 | 1 **ON | 1**
 Data logging function is activated.
OFF | 0
 Data logging function is deactivated.
 *RST: OFF | 0

Manual operation: See ["ACT. <channel>"](#) on page 77

DATA:DATA? {<Filename>},{[INT | EXT | DEF]}

Returns the logging file data values of the selected storage location and file name. If no logging file is found, the message "No Logging Files found" is displayed. If no storage location is selected, the instrument queries the internal memory. Please notice that the logging function has to be activated, if you want to use the manual trigger mode (trigger via TRIG button). Without activating the logging function in manual trigger mode, the instrument is not able to save a logging file internally or on the USB stick.

Parameters:

<Filename> e.g. "LOG0029.CSV"

INT

Internal memory.

EXT

USB stick.

DEF

Internal memory.

Example:

External logging file (USB stick), count = 5

```
DATA:DATA? 'LOG0001.CSV',EXT ->
```

```
U1[V];I1[A];U2[V];I2[A];U3[V];I3[A];Timestamp
```

```
0.019;2.0310;1.000;0.0000;1.000;0.0000;03:45:29:376
```

```
0.020;2.0310;1.000;0.0000;1.000;0.0000;03:45:30:375
```

```
0.020;2.0310;1.000;0.0000;1.000;0.0000;03:45:31:374
```

```
0.020;2.0310;1.000;0.0000;1.000;0.0000;03:45:32:373
```

```
0.019;2.0310;1.000;0.0000;1.000;0.0000;03:45:33:372
```

Usage:

Query only

DATA:DELeTe {<Filename>},{[INT | EXT | DEF]}

Deletes the logging file data values of the selected storage location and file name. If no storage location is selected, the instrument uses the internal memory. Take note that the logging function has to be activated, if you want to use the manual trigger mode (trigger via TRIG button). Without activating the logging function in manual trigger mode, the instrument is not able to save a logging file internally or on the USB stick.

Parameters:

<Filename> e.g. "LOG0001.CSV"

INT

Internal memory.

EXT

USB stick.

DEF

Internal memory.

Example:

```
DATA:DEL "LOG0001.CSV",EXT
```

Manual operation: See "[Delete file](#)" on page 81

DATA:LIST? [{INT | EXT | DEF}]

Queries all saved logging files of the selected storage location. If no storage location is selected, the instrument queries the internal memory. Take note that the logging function has to be activated, if you want to use the manual trigger mode (trigger via TRIG button). Without activating the logging function in manual trigger mode, the instrument is not able to save a logging file internally or on the USB stick. If you store the logging file on the USB stick, the query returns all files depending on the storage format (CSV or TXT files).

Parameters:

INT EXT DEF	INT Internal memory.
	EXT USB stick.
	DEF Internal memory.

Example: DATA:LIST? EXT -> "LOG0001.CSV", "LOG0002.CSV",
"LOG0003.CSV"

Usage: Query only

DATA:POINTS? {<Filename>},{[INT | EXT | DEF]}

Queries the number of log file values of the selected storage location and file name. If no storage location is selected, the instrument queries the internal memory. Take note that the logging function has to be activated, if you want to use the manual trigger mode (trigger via TRIG button). Without activating the logging function in manual trigger mode, the instrument is not able to save a logging file internally or on the USB stick.

Example: External logging file (USB stick), count = 5
DATA:DATA? 'LOG0001.CSV', EXT -> 5

Usage: Query only

HCOPY:DATA?

Returns the actual display content (screenshot). The DATA? query responses the screenshot data in binary format.

Usage: Query only

Manual operation: See "SAVE" on page 99

HCOPY:FORMat {BMP | PNG}**HCOPY:FORMat?**

Sets or queries the data format of the screenshot.

Parameters:

BMP | PNG

BMP

Windows Bitmap Format.

PNG

Portable Network Graphic.

Manual operation: See "[FORMAT](#)" on page 98

HCOPY:SIZE:X?

Returns the horizontal expansion of the screenshots.

Usage: Query only

HCOPY:SIZE:Y?

Returns the vertical expansion of the screenshots.

Usage: Query only

9.9 Status reporting commands

The status reporting system stores all information on the present operating state of the instrument, and on errors which have occurred. This information is stored in the status registers and in the error queue. The `STATUS:OPERation` and `STATUS:QUESTionable` subsystems contains commands to control the status reporting structure of the instrument.

See [Chapter 8.4.1, "Structure of a SCPI status register"](#), on page 128.

9.9.1 STATUS:OPERation registers

The commands of the `STATUS:OPERation` subsystem control the status reporting structures of the `STATUS:OPERation` register.

STATUS:OPERation:CONDition?

Returns the `CONDition` part of the operational status register.

Parameters:

<Condition>

Condition bits in decimal representation.

Range: 1 to 65535

Usage: Query only

STATus:OPERation:ENABLE <Enable_value>

STATus:OPERation:ENABLE?

Sets or queries the bits in the enable register for the Standard Operation Register group.

Parameters:

<Enable_value> Enable bit register
 Range: 1 to 65535

STATus:OPERation[:EVENT]?

Returns the contents of the `EVENTt` part of the status register to check whether an event has occurred since the last reading. Reading an `EVENTt` register deletes its contents.

Parameters:

<Event> Contents of the `EVENTt` part of the status register.
 Range: 1 to 65535

Usage: Query only

9.9.2 STATus:QUEStionable registers

The commands of the `STATus:QUEStionable` subsystem control the status reporting structures of the `STATus:QUEStionable` registers:

STATus:PRESet

Resets all bits of the `STATus:QUEStionable` and Standard Operation enable register.

Usage: Event

STATus:QUEStionable[:EVENT]?

Queries the contents of the `EVENTt` part of the status register to check whether an event has occurred since the last reading. Reading an `EVENTt` register deletes its contents.

Parameters:

<Event> Event bits in decimal representation.
 Range: 1 to 65535

Usage: Query only

STATus:QUESTIONable:ENABLE <Enable_value>

Sets the enable mask that allows true conditions in the `EVENT` part to be reported in the summary bit. If a bit in the enable part is set to 1 and its associated event bit transitions to true, a positive transition occurs in the summary bit and is reported to the next higher level.

Parameters:

<Enable_value> Bit mask in decimal representation.
Range: 1 to 65535

STATus:QUESTIONable:ENABLE?

Queries the enable register and returns a decimal value which corresponds to the binary-weighted sum.

Usage: Query only

STATus:QUESTIONable:INSTrument[:EVENT]?

Queries the contents of the `EVENT` part of the status register to check whether an event has occurred since the last reading. Reading an `EVENT` register deletes its contents.

Parameters:

<Event> Event bits in decimal representation.
Range: 0 to 65535

Usage: Query only

STATus:QUESTIONable:INSTrument:ENABLE <Enable_value>

Sets the enable mask that allows true conditions in the `EVENT` part to be reported in the summary bit. If a bit in the enable part is set to 1 and its associated event bit transitions to true, a positive transition occurs in the summary bit and is reported to the next higher level.

Parameters:

<Enable_value> Bit mask in decimal representation.
Range: 0 to 65535

STATus:QUESTIONable:INSTrument:ENABLE?

Queries the enable register and returns a decimal value which corresponds to the binary weighted sum.

STATus:QUESTionable:INSTrument:ISUMmary<n>[:EVENT]?

Queries the contents of the `EVENT` part of the status register to check whether an event has occurred since the last reading. Reading an `EVENT` register deletes its contents.

Parameters:

<Event> Event bits in decimal representation.
Range: 0 to 65535

Usage: Query only

STATus:QUESTionable:INSTrument:ISUMmary<n>:CONDition?

Queries the contents of the `CONDition` part of the status register to check the actual instrument states. Reading the `CONDition` registers does not delete the contents.

Parameters:

<Condition> Condition bits in decimal representation.
Range: 0 to 65535

Usage: Query only

STATus:QUESTionable:INSTrument:ISUMmary<n>:ENABLE <Enable value>

Sets the enable mask that allows true conditions in the `EVENT` part to be reported in the summary bit. If a bit in the enable part is set to 1 and its associated event bit transitions to true, a positive transition occurs in the summary bit and is reported to the next higher level.

Parameters:

<Enable value> Bit mask in decimal representation.
Range: 0 to 65535

STATus:QUESTionable:INSTrument:ISUMmary<n>:ENABLE?

Queries the enable register and returns a decimal value which corresponds to the binary weighted sum.

Usage: Query only

10 Troubleshooting

- [Displaying status information](#)..... 180
- [Problems during firmware update](#)..... 180
- [Problems with remote control over LAN](#)..... 181
- [Contacting customer support](#)..... 181

10.1 Displaying status information

The R&S NGC100 displays notifications to inform you on current settings and states. It distinguishes between status, information, and warning and error notifications.

Some information and messages are entered in the error/event queue of the status reporting system, see [Chapter 8.4, "Status reporting system"](#), on page 128.

10.2 Problems during firmware update

The firmware update is described in [Chapter 7.1, "Update \(firmware\)"](#), on page 100.

Solutions for potential problems that can occur during firmware update are described in the following sections.

Firmware update was interrupted

If, for example, a power cut happens during the firmware update, problems can occur.

1. Perform the firmware update again. Sometimes, a further update fixes the problems.
2. If you nevertheless cannot update the R&S NGC100, contact the local service representative, see [Chapter 10.4, "Contacting customer support"](#), on page 181.

Firmware update was aborted

If there is not enough free memory space, the firmware update aborts. The instrument displays an error message.

- ▶ Start the firmware update again.

10.3 Problems with remote control over LAN

10.3.1 Cannot establish a LAN connection

If you have problems to establish a LAN connection as described in [Chapter 8.1.1, "LAN interface"](#), on page 114:

1. Check if the TCP/IP address information is valid.
2. Assign the IP address manually, e.g. if the network does not support DHCP configuration.

10.3.2 Cannot communicate over LAN

If you have problems to establish the LAN communication:

1. Refer to the application note [1SL374: How to communicate with R&S devices using VISA](#), that provides comprehensive information on configuring the interfaces, required drivers, and testing the communication.
2. If you still have problems, contact the customer support.

10.4 Contacting customer support

Technical support – where and when you need it

For quick, expert help with any Rohde & Schwarz product, contact our customer support center. A team of highly qualified engineers provides support and works with you to find a solution to your query on any aspect of the operation, programming or applications of Rohde & Schwarz products.

Contact information

Contact our customer support center at www.rohde-schwarz.com/support, or follow this QR code:

11 Transport

Lifting and carrying

See "[Lifting and carrying the product](#)" on page 10.

Packing

Use the original packaging material. It consists of antistatic wrap for electrostatic protection and packing material designed for the product.

If you do not have the original packaging, use similar materials that provide the same level of protection.

Securing

When moving the product in a vehicle or using transporting equipment, make sure that the product is properly secured. Only use items intended for securing objects.

Transport altitude

Unless otherwise specified in the data sheet, the maximum transport altitude without pressure compensation is 4500 m above sea level.

12 Maintenance, storage and disposal

The product does not require regular maintenance. It only requires occasional cleaning. It is however advisable to check the nominal data from time to time.

- [Cleaning](#)..... 184
- [Changing fuses](#)..... 184
- [Internal battery replacement](#)..... 184
- [Storage](#)..... 185
- [Disposal](#)..... 185

12.1 Cleaning

How to clean the product is described in "[Cleaning the product](#)" on page 12.

Do not use any liquids for cleaning. Cleaning agents, solvents, acids and bases can damage the front panel labeling, plastic parts and display.

12.2 Changing fuses

If the product does not start, it is possible that a blown fuse is the cause. The fuse is located in the socket of the power supply.

For details on changing fuses, see "[Replacing the power fuse](#)" on page 23.

12.3 Internal battery replacement

An internal CR2032 coin cell battery powers the real-time clock circuit which provides continuous time stamp for the instrument. If the battery fails, the system clock and time stamp for the logging function are not available but other instrument functions are not affected.

Under normal usage at room temperature, the battery is expected to last up to 10 years. However, the battery life expectancy is reduced if the device is stored at temperature above 40°C for an extended period of time.



If the instrument cannot retain the date and time settings after turning off the AC input, the battery is discharged.

Contact your local service partner for battery replacement.

12.4 Storage

Protect the product against dust. Ensure that the environmental conditions, e.g. temperature range and climatic load, meet the values specified in the data sheet.

12.5 Disposal

Rohde & Schwarz is committed to making careful, ecologically sound use of natural resources and minimizing the environmental footprint of our products. Help us by disposing of waste in a way that causes minimum environmental impact.

Disposing of electrical and electronic equipment

A product that is labeled as follows cannot be disposed of in normal household waste after it has come to the end of its life. Even disposal via the municipal collection points for waste electrical and electronic equipment is not permitted.



Figure 12-1: Labeling in line with EU directive WEEE

Rohde & Schwarz has developed a disposal concept for the eco-friendly disposal or recycling of waste material. As a manufacturer, Rohde & Schwarz completely fulfills its obligation to take back and dispose of electrical and electronic waste. Contact your local service representative to dispose of the product.

13 Applications

To increase output voltage and currents, it is possible to operate the channels in series or parallel mode. In general, the output voltages of R&S NGC100 to be combined are independent.

For safety information, see [Chapter 3.1.6, "Connecting to power"](#), on page 22.

13.1 Series mode

This type of interconnection adds the individual output voltages. The same current flows through all outputs. The current limits for the outputs wired in series should be set to the identical value. If one of the outputs exceeded the current limit, the total voltage will naturally collapse. See [Chapter 4.3, "Operation modes"](#), on page 52.

It is advisable to set the voltages of all connected channels voltages to a similar value to distribute the loads evenly (not absolutely necessary). When all three channels are connected in a series mode and if a (low resistance) load is connected; there is a chance of damaging a channel when that channel is switched off. This is due to the protection diode working as a bypass to connect the other channel in a series mode. Once the protection diode is shorted, the channel will be defective.

Therefore, it is necessary to always have all channels or no channel at all switched on.



If the instrument switches to constant current (CC) mode during a series connection, the voltage display becomes inaccurate.

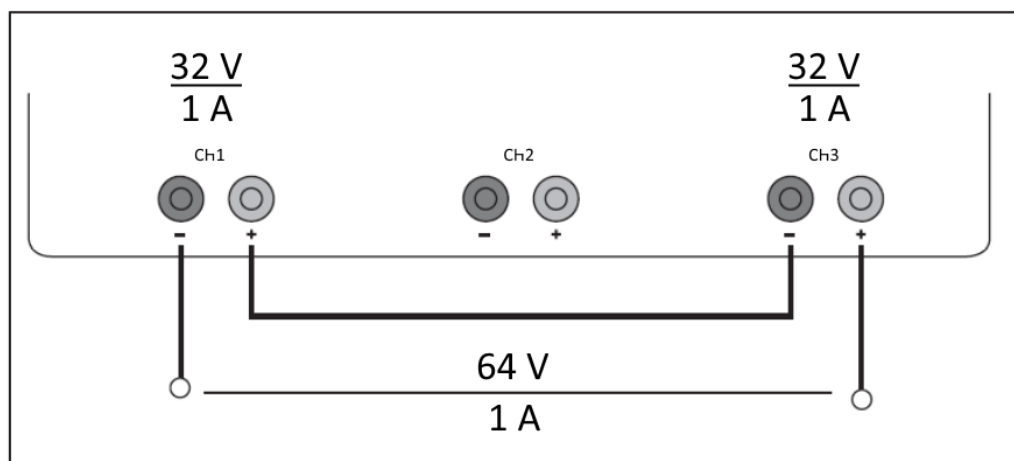

Figure 13-1: Example of series connection

13.2 Parallel mode

If it is necessary to increase the total current, the power supply outputs must be wired in parallel. The maximum total current is the sum of the individual currents of all sources connected in parallel. The output voltages for the individual outputs should be set to the same voltage value as precisely as possible. For slight voltage differences, it is common in this operating mode to first charge a voltage output up to the current limit; the other voltage output provides the remaining current. See "[Principles of operation in parallel mode](#)" on page 187.

For power supplies that are connected in parallel, it is possible that compensating currents flow within the power supplies. The use of power supplies by other manufacturers, which are potentially not overload proof, can cause destruction of these units as currents may be distributed unevenly.

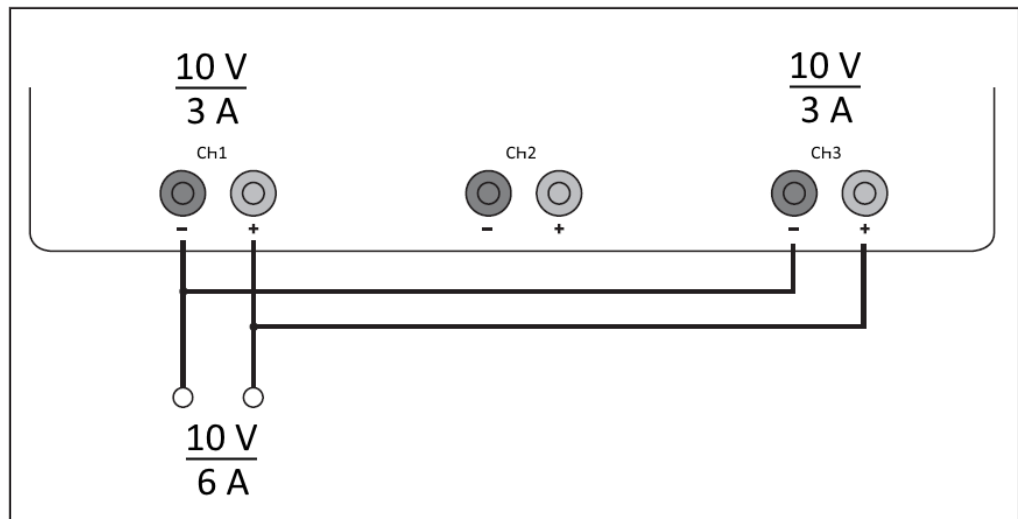

Figure 13-2: Example of parallel connection

Principles of operation in parallel mode

Generally, a higher current is first supplied from the channel with the higher output voltage. Once this channel reaches its power limit, the remaining current is made available by the channel that is connected in parallel. In this scenario, it is unpredictable which channel supplies the higher current because it is also possible for channels with identical voltage values to display a low voltage difference.

By increasing the voltage slightly, the load distribution can be manipulated. If the voltage for a channel is to be increased by 50 mV, for instance (by a set of identical cables), the current will initially be provided by this channel.

If you wish to distribute the load to multiple channels, it is recommended to set the current limit of the channel that is to supply the main current to a fraction of the current. This approach handles the semiconductor with care and improves the heat dissipation, as the power loss is distributed more evenly.

Annex

A Additional basics on remote control

A.1 Messages and SCPI command structure

A.1.1 Messages

Instrument messages are employed in the same way for all interfaces, if not indicated otherwise in the description.

- Structure and syntax of the instrument messages: [Chapter A.1.2, "SCPI command structure"](#), on page 189
- Detailed description of all messages: [Chapter 9, "Remote control commands"](#), on page 133

There are different types of instrument messages:

- Commands
- Instrument responses

Commands

Commands (program messages) are messages which the controller sends to the instrument. They operate the instrument functions and request information. The commands are subdivided according to two criteria:

Effects on the instrument:

- Setting commands cause instrument settings such as a reset of the instrument or setting the output voltage.
- Queries return data for remote control, e.g. for identification of the instrument or polling a parameter value. Queries are formed by appending a question mark to the command header.

Applied standards:

- The function and syntax of the common commands are precisely defined in standard IEEE 488.2. If implemented, they are used identically on all instruments. They refer to functions such as management of the standardized status registers, reset and self-test.
- Instrument control commands refer to functions depending on the features of the instrument such as voltage settings. Many of these commands have also been standardized by the SCPI committee. These commands are marked as "SCPI compliant" in the command reference chapters. Commands without this SCPI label

are device-specific, however, their syntax follows SCPI rules as permitted by the standard.

Instrument responses

Instrument responses (response messages and service requests) are messages which the instrument sends to the controller after a query. They can contain measurement results, instrument settings and information on the instrument status.

GPIB Interface Messages

Interface messages are transmitted to the instrument on the data lines with the attention line (ATN) being active (LOW). They are used for communication between the controller and the instrument and can only be sent by a PC which has the function of a GPIB bus controller. GPIB interface messages can be further subdivided into:

- **Universal commands** act on all instruments connected to the GPIB bus without previous addressing; universal commands are encoded in the range 0x10 through 0x1F. They affect all instruments connected to the bus and do not require addressing.
- **Addressed commands** only act on instruments previously addressed as listeners; addressed commands are encoded in the range 0x00 through 0x0F. They only affect instruments addressed as listeners.

A.1.2 SCPI command structure

SCPI commands consist of a so-called header and, usually, one or more parameters. The header and the parameters are separated by a whitespace. The headers can consist of several mnemonics (keywords). Queries are formed by appending a question mark directly to the header. The commands can be either device-specific or device-independent (common commands). Common and device-specific commands differ in their syntax.

Syntax for common commands

Common (= device-independent) commands consist of a header preceded by an asterisk (*) and possibly one or more parameters.

Table A-1: Examples of common commands

Command	Command name	Description
*RST	Reset	Resets the instrument.
*ESE	Event Status Enable	Sets the bits of the event status enable registers.
*ESR?	Event Status Query	Queries the content of the event status register.
*IDN?	Identification Query	Queries the instrument identification string.

Syntax for device-specific commands

For demonstration purposes only, assume the existence of the following commands for this section:

- MEASure:CURRent[:DC]?
- MEASure:VOLTage[:DC]?
- FUSE[:STATe] {0 | 1}
- FUSE[:STATe]?

Long and short form

The mnemonics feature a long form and a short form. The short form is marked by uppercase letters, the long form corresponds to the complete word. You can enter either the short form or the long form; other abbreviations are not permitted.

Example:

MEASure:CURRent? is equivalent to MEAS:CURR?.



Case-insensitivity

Uppercase and lowercase notation only serves to distinguish the two forms in the manual, the instrument itself is case-insensitive.

Numeric suffixes

If a command can be applied to multiple instances of an object, e.g. specific channels or sources, the required instances can be selected by a suffix added to the command. Numeric suffixes are indicated by angular brackets (<1...4>, <n>, <i>). They are replaced by a value without brackets in the command.

SCPI prescribes that suffix counting starts with 1. Suffix 1 is the default state and used when no suffix is specified.

Example:

Definition: CHANnel<n>:LIMit<n>:SOURCE?

Command: CHAN:LIM2:SOUR?

This command queries the 2nd limit in channel 1.

Optional mnemonics

Some command systems permit inserting or omitting certain mnemonics in the header. These mnemonics are marked by square brackets. The instrument must recognize the long command to comply with the SCPI standard. Some commands are shortened by these optional mnemonics.



Optional mnemonics with numeric suffixes

Do not omit an optional mnemonic if it includes a numeric suffix that is relevant for the effect of the command.

Example:

CHANnel<n>[:ACQuisition]:MODE?

CHAN:ACQ:MODE? is equivalent to CHAN:MODE?.

Note that an optional mnemonic with a numeric suffix automatically selects 1 if you omit the optional part of the command, e.g.:

Definition: CHANnel<n>:MEASurement:FUNCtions? [<n>]

Command: CHAN:MEAS:FUNC? queries the list of all function names in channel 1.

To query a single function, e.g. at index 3 in channel 2, include the optional CHANnel suffix and the index of the function.

Command: CHAN2:MEAS:FUNC? 3

FUSE[:STATe] { ON }

FUSE:STAT ON is equivalent to FUSE ON.

A.1.3 SCPI parameters

Many commands are supplemented by a parameter or a list of parameters. The parameters must be separated from the header by a whitespace (ASCII code 0 to 9, 11 to 32 decimal, e.g. blank). If several parameters are specified in a command, they are separated by a comma ",".

Allowed parameters are:

- Numeric values
- Special numeric values
- Boolean parameters
- Text
- Character strings
- Block data

The required parameters and the allowed value range are specified in the command description.

Numeric values

You can enter numeric values either with sign, decimal point or exponentially ("E" or "e"). The mantissa range is up to 255 characters, the value range of the exponent is -32000 to 32000. Values exceeding the resolution of the instrument are rounded up or down.

Example:

VOLT 10V = VOLT 10

VOLT 100mV = VOLT 0.1

VOLT 500mV is equivalent to VOLT 500e-3.

Special numeric values

The text listed below are interpreted as special numeric values. In the case of a query, the numeric value is provided.

- MIN/MAX
- MINimum and MAXimum denote the minimum and maximum value

Example:

```
VOLT:PROT? MAX
```

Returns the maximum numeric value.

Boolean parameters

Boolean parameters represent two states:

- **On** (logically true), is represented by "On" or the numeric value "1"
- **Off** (logically false), is represented by "Off" or the numeric value "0"

The instrument returns the numerical value when queried.

Example:

```
OUTP:STAT ON
```

```
OUTP:STAT? -> 1
```

Text

Text parameters observe the syntactic rules for key words, i.e. they can be entered using a short or long form. Like any parameter, they have to be separated from the header by a white space.

Example:

```
ARBITrary:TRIGgered:MODE
```

```
ARBITrary:TRIGgered:MODE SING
```

```
ARBITrary:TRIGgered:MODE? -> "SINGle"
```

Character strings

Strings must always be entered in quotation marks (' or ").

Example:

```
SYSTem:COMMunicate:SOCKet:IPADdress "192.168.1.128"
```

```
SYSTem:COMMunicate:SOCKet:IPADdress '192.168.1.128'
```

Block data

Block data is a transmission format which is suitable for the transmission of large amounts of data. A command using a block data parameter has the following structure:

Example:

```
HEADer:HEADer #45168xxxxxxxx
```

ASCII character # introduces the data block. The next number indicates how many of the following digits describe the length of the data block. In the example, the four following digits indicate the length to be 5168 bytes. The data bytes follow. During the transmission of these data bytes all end or other control signs are ignored until all bytes are transmitted.

#0 specifies a data block of indefinite length. The use of the indefinite format requires a `NL^END` message to terminate the data block. This format is useful when the length of the transmission is not known or if speed or other considerations prevent segmentation of the data into blocks of definite length.

A.1.4 Overview of syntax elements

The following tables provide an overview of the syntax elements and special characters.

Table A-2: Syntax elements

:	A colon separates the mnemonics of a command.
;	The semicolon separates two commands within a program message. It does not alter the path.
,	A comma separates several parameters of a command.
?	A question mark forms a query.
*	An asterisk marks a common command.
"	Quotation marks introduce a string and terminate it.
	A whitespace (ASCII-Code 0 to 9, 11 to 32 decimal, e.g. blank) separates the header from the parameters.

Special characters

Table A-3: Special characters

	<p>A vertical stroke in parameter definition indicates alternative possibilities in the sense of "or". The effect of the command differs, depending on the used parameter.</p> <p>Example:</p> <ul style="list-style-type: none"> • FUSE:LINK {1 2 3} • FUSE:LINK 1 sets the fuse link CH1 for the selected channel FUSE:LINK 2 sets the fuse link of CH2 for the selected channel
[]	<p>Mnemonics in square brackets are optional and can be inserted into the header or be omitted.</p> <p>Example:</p> <ul style="list-style-type: none"> • FUSE[:STATe] { ON } • FUSE:STAT ON is equivalent to FUSE ON
{ }	<p>Parameters in curly brackets are optional and can be inserted once or several times, or be omitted.</p> <p>Example:</p> <ul style="list-style-type: none"> • VOLTage[:LEVel][:IMMediate][:AMPLitude] {<voltage> MIN MAX UP DOWN } <p>The following are valid commands:</p> <ul style="list-style-type: none"> - VOLT MAX - VOLT MIN - VOLT 10

A.1.5 Responses to queries

A query is defined for each setting command unless otherwise specified. The query is set by the question mark at the end of the header. According to SCPI, the responses to some query commands are subject to stricter rules than in defined standard IEEE 488.2.

- The requested parameter is transmitted without a header.
ARBitrary:TRIGgered:MODE? -> "SINgle"
- Maximum values, minimum values and all other quantities that are requested via a special text parameter are returned as numeric values.
VOLT:PROT? MAX -> 32.500
- Boolean values are returned as 0 (for Off) and 1 (for On).
OUTPut:STATe? -> 1

A.2 Command sequence and synchronization

A sequential command finishes the execution before the next command is starting. To make sure that commands are actually carried out in a certain order, each command must be sent in a separate command line.



As a general rule, send commands and queries in different program messages.

A.2.1 Preventing overlapping execution

To prevent an overlapping execution of commands the commands `*OPC`, `*OPC?` or `*WAI` can be used. All three commands cause a certain action only to be carried out after the hardware has been set. The controller can be forced to wait for the corresponding action.



The R&S NGC100 series does not support parallel processing of remote commands. If `OPC?` returns a "1", the device is able to process new commands.

Table A-4: Synchronization using `*OPC`, `*OPC?` and `*WAI`

Command	Action	Programming the controller
<code>*OPC</code>	Sets the Operation Complete bit in the ESR after all previous commands have been executed.	<ul style="list-style-type: none"> Setting bit 0 in the ESE Setting bit 5 in the SRE Waiting for service request (SRQ)
<code>*OPC?</code>	Stops command processing until 1 is returned. It occurs after the Operation Complete bit has been set in the ESR. This bit indicates that the previous setting has been completed.	Sending <code>*OPC?</code> directly after the command whose processing should be terminated before other commands can be executed.
<code>*WAI</code>	Stops further command processing until all commands have been executed before <code>*WAI</code> .	Sending <code>*WAI</code> directly after the command whose processing should be terminated before other commands are executed

Command synchronization using `*WAI` or `*OPC?` is a good choice if the overlapped command takes only little time to process. The two synchronization commands simply block overlapped execution of the command. Append the synchronization command to the overlapping command, for example:

```
SINGLE; *OPC?
```

For time consuming overlapped commands, you can allow the controller or the instrument to do other useful work while waiting for command execution. Use one of the following methods:

***OPC with a service request**

1. Set the OPC mask bit (bit no. 0) in the ESE: `*ESE 1`
2. Set bit no. 5 in the SRE: `*SRE 32` to enable ESB service request.
3. Send the overlapped command with `*OPC`.
4. Wait for a service request.

The service request indicates that the overlapped command has finished.

***OPC? with a service request**

1. Set bit no. 4 in the SRE: `*SRE 16` to enable MAV service request.

2. Send the overlapped command with `*OPC?`.
3. Wait for a service request.

The service request indicates that the overlapped command has finished.

Event status register (ESE)

1. Set the OPC mask bit (bit no. 0) in the ESE: `*ESE 1`
2. Send the overlapped command without `*OPC`, `*OPC?` or `*WAI`.
3. Poll the operation complete state periodically (with a timer) using the sequence:
`*OPC; *ESR?`

A return value (LSB) of 1 indicates that the overlapped command has finished.

*OPC? with a short timeout

1. Send the overlapped command without `*OPC`, `*OPC?` or `*WAI`.
2. Poll the operation complete state periodically (by means of a timer) using the sequence: (short timeout); `*OPC?`.
3. A return value (LSB) of 1 indicates that the overlapped command has finished. In case of a timeout, the operation is ongoing.
4. Reset timeout to former value
5. Clear the error queue with `SYStem:ERRor?` to remove the "-410, Query interrupted" entries.

A.2.2 Using several threads in the controller application

Provided the programming environment of the controller application supports threads, you can use separate threads for the application GUI and for controlling the instrument using SCPI commands. A thread waiting for an `*OPC?` response does not block the GUI or the communication with other instruments.

List of commands

[DATA:]LOG:CHANnel[:STATe].....	171
[DATA:]LOG:COUNT.....	171
[DATA:]LOG:FNAME.....	171
[DATA:]LOG:FORMat.....	172
[DATA:]LOG:INTerval.....	172
[DATA:]LOG:MODE.....	172
[DATA:]LOG:TIME.....	173
[DATA:]LOG:TRIGgered.....	173
[DATA:]LOG[:STATe].....	173
[SOURce:]CURRent[:LEVel][:IMMediate][:AMPLitude].....	144
[SOURce:]CURRent[:LEVel][:IMMediate][:AMPLitude] {UP DOWN}.....	145
[SOURce:]CURRent[:LEVel][:INCRement].....	145
[SOURce:]POWer:PROTection:CLEar.....	156
[SOURce:]POWer:PROTection:LEVel.....	157
[SOURce:]POWer:PROTection:TRIPped?.....	157
[SOURce:]POWer:PROTection[:STATe].....	157
[SOURce:]VOLTage:AINPut:INPut.....	166
[SOURce:]VOLTage:AINPut:MODE.....	166
[SOURce:]VOLTage:AINPut:THReshold.....	167
[SOURce:]VOLTage:AINPut[:STATe].....	167
[SOURce:]VOLTage:PROTection:CLEar.....	154
[SOURce:]VOLTage:PROTection:LEVel.....	154
[SOURce:]VOLTage:PROTection:MODE.....	154
[SOURce:]VOLTage:PROTection:TRIPped?.....	155
[SOURce:]VOLTage:PROTection[:STATe].....	155
[SOURce:]VOLTage:RAMP:DURation.....	165
[SOURce:]VOLTage:RAMP[:STATe].....	165
[SOURce:]VOLTage[:LEVel][:IMMediate][:AMPLitude].....	142
[SOURce:]VOLTage[:LEVel][:IMMediate][:AMPLitude] {UP DOWN}.....	143
[SOURce:]VOLTage[:LEVel][:INCRement].....	143
*CLS.....	133
*ESE.....	133
*ESR?.....	134
*IDN?.....	134
*OPC.....	134
*RCL.....	136
*RST.....	134
*SAV.....	135
*SRE.....	135
*STB?.....	135
*TST?.....	135
*WAI.....	135
APPLY.....	146
ARbitrary:BEHavior:END.....	161
ARbitrary:CLEar.....	161
ARbitrary:DATA.....	164
ARbitrary:ENDPoint.....	161

ARbitrary:FNAME.....	162
ARbitrary:LOAD.....	162
ARbitrary:REPetitions.....	162
ARbitrary:SAVE.....	162
ARbitrary:TRIGgered:MODE.....	163
ARbitrary:TRIGgered[:STATe].....	163
ARbitrary[:STATe].....	164
DATA:DATA?.....	174
DATA:DELeTe.....	174
DATA:LIST?.....	175
DATA:POINts?.....	175
DISPlay:TEXT:CLEAr.....	138
DISPlay:TEXT[:DATA].....	139
FUSE:DELaY.....	150
FUSE:LINK.....	150
FUSE:TRIPed?.....	151
FUSE:UNLink {1 2 3}.....	151
FUSE[:STATe].....	151
HCOPy:DATA?.....	175
HCOPy:FORMat.....	176
HCOPy:SIZE:X?.....	176
HCOPy:SIZE:Y?.....	176
INSTRument:NSElect.....	140
INSTRument[:SElect].....	141
MEASure[:SCALar]:CURRent[:DC]?.....	158
MEASure[:SCALar]:ENERgy:RESet.....	159
MEASure[:SCALar]:ENERgy:STATe.....	158
MEASure[:SCALar]:ENERgy?.....	158
MEASure[:SCALar]:POWER[:DC]?.....	159
MEASure[:SCALar]:VOLTage[:DC]?.....	159
OUTPut:CHANnel[:STATe].....	147
OUTPut:MASTer[:STATe].....	148
OUTPut[:STATe].....	148
SEQuence:CHANnel[:STATe].....	168
SEQuence:DELaY.....	168
SEQuence:TRIGgered.....	168
SEQuence[:STATe].....	169
STATus:OPERation:CONDition?.....	176
STATus:OPERation:ENABle.....	177
STATus:OPERation[:EVENT]?.....	177
STATus:PRESet.....	177
STATus:QUEStionable:ENABle.....	178
STATus:QUEStionable:ENABle?.....	178
STATus:QUEStionable:INSTRument:ENABle.....	178
STATus:QUEStionable:INSTRument:ENABle?.....	178
STATus:QUEStionable:INSTRument:ISUMmary<n>:CONDition?.....	179
STATus:QUEStionable:INSTRument:ISUMmary<n>:ENABle.....	179
STATus:QUEStionable:INSTRument:ISUMmary<n>:ENABle?.....	179
STATus:QUEStionable:INSTRument:ISUMmary<n>[:EVENT]?.....	179
STATus:QUEStionable:INSTRument[:EVENT]?.....	178

STATus:QUEStionable[:EVENT]?	177
SYSTem:BEEPer:STATe	137
SYSTem:BEEPer[:IMMediate]	137
SYSTem:ERRor[:NEXT]?	137
SYSTem:LOCal	137
SYSTem:REMote	138
SYSTem:RWLock	138
SYSTem:VERsion?	138
TRIGger:SLOPe	139



北京海洋兴业科技股份有限公司 (证券代码: 839145)

北京市西三旗东黄平路19号龙旗广场4号楼 (E座) 906室

电话: 010-62176775 62178811 62176785 邮编: 100096

传真: 010-62176619

邮箱: market@oitek.com.cn

企业官网: www.hxyyq.com

购线网: www.gooxian.com



公司官网



微信公众号



微信视频号

Index

Symbols

*OPC	195
*OPC?	195
*WAI	195

A

About	
CSV	108
Access	
Activating fuse	57
Analog input	65
Channel output	56
CSV	109
Data logging	76
Date time	104
Device information	103
Device name	108
Display settings	106
EasyArb	83
EasyRamp	92
Energy meter	73
Ethernet settings	114
External trigger	71
Fuse delay, fuse linking	59
GPIB	120
Instrument menus	42
Interface	101, 113
Key brightness	107
Miscellaneous functions	102
Power up mode	110
Protection function	62
Reset default settings	111
Save and recall	94
Screenshot	98
Sequencing	68
Setup	100
Sound	105
Statistics	72
Tracking function	60
USB mode	118
Voltage and current	54
Activate channel output	55
Activating fuse	57
Access	57
Active elements	40
Advanced functions	
EasyArb	82
EasyRamp	92
Advanced commands	
Analog In	165
Arbitrary commands	159
EasyRamp commands	164
Sequencing	167
Alphanumeric parameters	44
Analog input	65
Access	65
How to: set	66
Analog input range	65
Application cards	17
Application notes	17

Applications	
Parallel mode	187
Series mode	186
Arrow keys	50

B

Back key	
Front panel keys	46
Backlight	
Display	106
Setup	106
Beeper	105
Bench top, placing the R&S NGC100	19
Block data	
SCPI parameters	192
Boolean	
SCPI parameters	192
Brightness	
Setup	106

C

Calibration certificate	16
Carrying the instrument	18
Channel	
How to: select different channels	32
Channel display area	39
Statistic function	39
Channel output	
Access	56
How to: activate channel output	34
How to: activating	56
Character strings	
SCPI parameters	192
Checking the instrument	18
Clear status	
Remote	133
Command sequence	
Remote	135
Remote control basics	194
Commands	
Remote control basics	188
Common commands	
SCPI syntax	189
Configuration commands	
Channel selecting	139
Combine voltage and current setting	146
Current setting	143
Fuse setting	148
OPP setting	155
Output setting	146
OVP setting	152
Voltage setting	141
Connect to power	
How to:	22
Connecting	
Memory stick	26
Power	22
USB devices	26
Connecting to LAN	25

Connector		
AC power supply	30	
GPIB	30	
Ground terminal	31	
IEC/IEEE	30	
Kensington lock	31	
LAN	31	
Rear panel connector	31	
Terminal block	31	
USB B	31	
Contents of the status registers		
Application of the status reporting system	131	
Event status register (ESR) and event status enable register (ESE)	130	
STATUS:QUESTionable register	131	
Control beep		
Setup	105	
Create arbitrary waveform		
HMExplorer	85	
CSV		
About	108	
Access	109	
Miscellaneous functions	108	
CSV decimal point		
Setup	110	
CSV field delimiter		
Setup	110	
CSV settings		
Decimal point	110	
Field delimiter	110	
Line separator	110	
Current	53	
Customer support	181	
D		
Data entry	43	
Data logging		
Access	76	
How to: set	76	
Data sheet	16	
Date & time		
Miscellaneous functions	104	
Date time		
Access	104	
Day month year		
Setup	104	
Decimal point		
CSV settings	110	
Default settings		
General functions	111	
Setup	111	
Default values		
Remote	134	
Delete		
How to: delete instrument settings	95	
Derating graph		
Front panel	29	
Device information		
Access	103	
Miscellaneous functions	103	
Setup	103	
Device name		
Access	108	
How to: set	108	
Miscellaneous functions	108	
Setup	108	
Device-specific commands		
SCPI syntax	190	
Display		
Active elements	40	
Backlight	106	
Contrast	106	
Front panel	28	
Key brightness	106, 107	
Key fallback time	40, 107	
On-screen keypad	40	
Screen intensity	106	
Display contrast		
Setup	106	
Display information	36	
Display settings		
Access	106	
Miscellaneous functions	106	
Documentation overview	15	
Driver for remote control	17	
E		
EasyArb	82	
Access	83	
How to: set	83	
EasyRamp	92	
Access	92	
How to: set	92	
Electronic Fuse	57	
EMI		
Test considerations	22	
Energy meter		
Access	73	
How to: set	74	
Error beep		
Setup	105	
Ethernet settings		
Access	114	
Event status enable register (ESE)		
Remote	133	
Event status register (ESR)		
Remote	134	
External trigger	71	
Access	71	
F		
Field delimiter		
CSV settings	110	
File and data management	94	
Data logging	94	
Save recall	94	
Screenshot	97	
Firmware		
How to: update	101	
Setup	100	
Update	100	
Firmware update		
Notifications	180	
Front panel		
Derating graph	29	
Display	28	
Function keys	29	
Interactive softkeys	28	
Navigation controls	29	
Overview	26	
Power key	29	

Standby	29	How to:	
USB connector	29	Activating channel output	56
Front panel keys		Activating fuse control	57
Back key	46	Activating the channel output	34
Interactive softkeys	46	Adjust the GPIB bus address	121
Measurement parameter keys	47	Adjust the GPIB bus address on the controller	121
Utility keys	49	Assign IP address on controller	115
Function keys		Check LAN connection	115
Front panel	29	Connect to LAN	25
Fuse	58	Connect to power	22
Fuse control		Connect USB storage device	26
How to: activate	57	Connect wires to rear panel connector	32
Fuse delay	58	Delete	95
Fuse delay, fuse linking		Enter data	43
Access	59	Ground terminal	23
Fuse holder		Manual configuring of Ethernet settings	115
AC power supply	30	Mount the instrument in a rack	20
Fuses		Recall	95
How to replace the power fuse	23	Replace the power fuse	23
G		Return to manual operation	127
Gateway	116	Save	95
General functions		Select the channels	32
Backlight	106	Sequencing	68
Brightness	106	Set analog input	66
Contrast	106	Set data logging	76
Control beep	105	Set device name	108
CSV decimal point	110	Set EasyRamp	92
CSV field delimiter	110	Set energy meter	74
Day month year	104	Set output voltage and current limits	33
Default settings	111	Set OVP and OPP	63
Device information	103	Set statistics	72
Device name	108	Set tracking function	60
Error beep	105	Set voltage and current	54
Hour minutes	105	Start remote control session	127
Interface	101	Store and recall instrument settings	34
Key brightness	107	Switch on	24
Key fallback time	107	Unmount the instrument from a rack	20
Miscellaneous functions	102	Update firmware	101
Power up	111	I	
Save date time	104	Identification	
Update (firmware)	100	Remote	134
General instrument functions	100	Instrument	
Getting started	15	Carrying	18
GPIB		Checking	18
Access	120	Lifting	18
Characteristics	127	Operating site	18, 19
Interface	120	Tour	26
GPIB address	121	Unpacking	18
How to: adjust address	121	Instrument control	35
How to: adjust address on the controller	121	Manual operation	35
GPIB interface messages		Remote control	44
Remote control basics	189	Ways of operation	35
Ground terminal		Instrument responses	
Connector	31	Remote control basics	189
How to: ground terminal	23	Instrument security procedures	16
H		Instrument settings	
Help	16	How to: store and recall	34
Screenshot shortcut key	97	Recall	94
HMEplorer		Save	94
Create arbitrary waveform	85	Interactive softkeys	
Hour minutes		Front panel	28
Setup	105	Front panel keys	46
		Interface	
		Access	101, 113
		General functions	101

- GPIB 120
- LAN 114
- Remote control 112
- USB 118
- IP address 124
 - Dynamic 116
 - How to: assign address manually on the controller ... 115
 - How to: manual configuring of Ethernet settings 115
- IP address Mode 116
- IP-Status 117
- K**
- Kensington lock
 - Connector 31
- Key brightness
 - Access 107
 - Miscellaneous functions 107
 - Setup 107
- Key fallback time 40
 - Setup 107
- Key features 15
- Keyboard
 - On-screen 43
- Keypad
 - On-screen 43
- L**
- LAN
 - Connector 31
 - How to: check connection 115
 - Interface 114
 - IP address 124
- LAN communication
 - Problems 181
- LAN connection
 - Problems 181
- Lifting the instrument 18
- Limit
 - How to: set output voltage and current limits 33
- Line separator
 - CSV settings 110
- Live-mode 50
- Long and short form
 - SCPI syntax 190
- M**
- Mac address 116
- Maintenance, storage and disposal 184
 - Changing fuses 184
 - Cleaning 184
 - Disposal 185
 - Internal battery replacement 184
 - Storage 185
- Manual interaction 35
- Manual operation 35
- Measurement functions 71
 - Data logging 75
 - Energy meter 73
 - Statistics 71
- Measurement parameter keys
 - Front panel keys 47
- Messages
 - Remote control basics 188
- Miscellaneous functions
 - Access 102
 - CSV 108
 - Date & time 104
 - Device information 103
 - Device name 108
 - Display settings 106
 - General functions 102
 - Key brightness 107
 - Power up 110
 - Sound 105
- Mode
 - IP address 116
 - Operation modes 52
- Mounting, in a rack 20
- N**
- Navigation controls
 - Arrow keys 50
 - Front panel 29
 - Live-mode 50
 - Rotary knob 50
- Network link 117
- Network operation and remote control 112
- Numeric data entry 43
- Numeric parameters 43
- Numeric suffixes
 - SCPI syntax 190
- Numeric values
 - SCPI parameters 191
- O**
- On-screen keyboard 44
- On-screen keypad 40, 44
- Open source acknowledgment (OSA) 16
- Operating conditions 39
- Operating modes 39
- Operating site
 - Choosing 18
 - Setting up the instrument 19
- Operation
 - Manually 35
- Operation complete
 - Remote 134
- Operation modes
 - Constant current (CC) 52
 - Constant voltage (CV) 52
- Optional mnemonics
 - SCPI syntax 190
- Output terminals
 - Overview 29
- Overlapping commands
 - Preventing 195
- Overview
 - Front panel 26
 - Output terminals 29
 - Rear panel 30
- OVP and OPP
 - How to: set 63
- P**
- Parameters
 - Entering 43, 44
 - SCPI 191

Power	
Connecting the instrument	22
Power derating	51
Power key	
Front panel	29
Power key state	29
Power states	24
Power supply	
Connector	30
Fuse holder	30
Switch	30
Power supply models	26
Power switch	
AC power supply	30
Power up	
Miscellaneous functions	110
Setup	111
Power up mode	
Access	110
Preparing for use	18
Product introduction	15
Protection	62
Overpower protection (OPP)	62
Overvoltage protection (OVP)	62
Protection function	
Access	62
Protocol	
LXI browser interface	121
SCPI	123
VISA	123
Protocols	
Remote control	112
R	
Rack, mounting	20
Raw-port	117
Rear panel	
Overview	30
Rear panel connector	
Connector	31
Recall	
How to: recall instrument settings	95
Instrument settings	94
Release notes	16
Remote access	
GPIB address	121
IP address mode	116
IP-Status	117
Network gateway	116
Network IP address	116
Network link	117
Network Mac address	116
Network raw-port	117
Network transfer mode	117
Network VXI-11-port	117
Reset	117
Save	118
Save GPIB address	121
Subnet mask	116
USB	120
USB VCP	120
Remote control	44
Driver	17
General functions	101
GPIB interface	120
Interface	112
Interfaces	44
Protocols	112
Start	127
Stop	127
Remote control basics	
Command sequence	194
Commands	188, 189
GPIB interface messages	189
Messages	188
Responses to queries	194
SCPI command structure	189
SCPI parameters	191
Synchronization	194
Remote control commands	133
Advanced commands	159
Common setting commands	133
Configuration commands	139
Data and file management commands	169
Display commands	138, 139
Measurement commands	158
Status reporting commands	176
System commands	136
Remote control interface	
Setup	101
Remote control session	
How to: return to local	127
How to: start	127
Replace the power fuse	
How to:	23
Reset	117
Reset default settings	
Access	111
Reset values	
Remote	134
Resource string	
GPIB connection	126
LAN connection	124
USB connection	126
VISA	124
Responses to queries	
Remote control basics	194
Rotary knob	50
S	
Safety information	9
Safety instructions	9, 16
Save	118
How to: save instrument settings	95
Instrument settings	94
Save date time	
Setup	104
Save GPIB address	121
SCPI command structure	
Remote control basics	189
SCPI parameters	191
Block data	192
Boolean	192
Character strings	192
Numeric values	191
Special numeric values	192
Text	192
SCPI programmers manual	16
SCPI syntax	
Common commands	189
Device-specific commands	190
Long and short form	190

Numeric suffixes	190	Status reporting system	128
Optional mnemonics	190	Contents of the status registers	130
Special characters	194	Error queue	132
Syntax elements	193	Structure of a SCPI status register	128
Screen intensity		Subnet mask	116
Display	106	Switching on or off	24
Screen layout of R&S NGC100 models	36	Synchronization	
Screenshot		Remote control basics	194
Access	98	Syntax elements	
Screenshot shortcut key		SCPI syntax	193
Help	97	T	
Security procedures	16	Terminal block	
Self-test		Connector	31
Remote	135	Test considerations	
Sequencing	68	EMI	22
Access	68	General data on instrument specification	21
How to: set	68	Protection limits for R&S NGC100	22
Service request enable register (SRE)		Test setup	21
Remote	135	Test setup	
Set Current	53	Test considerations	21
Set EasyArb		Text	
How to:	83	SCPI parameters	192
Set Voltage	53	Text entry	43
Setting up remote control connection	124	Tracking function	60
Setup		Access	60
Access	100	How to: set	60
Backlight	106	Transfer	117
Brightness	106	Transport	183
Contrast	106	Troubleshooting	180
Control beep	105	Firmware update notifications	180
CSV decimal point	110	LAN communication problems	181
CSV field delimiter	110	LAN connection problems	181
Day month year	104	Status notifications	180
Default settings	111	Trying out	32
Device information	103	Activating the channel output	34
Device name	108	Selecting the channels	32
Error beep	105	Setting the output voltage and current limits	33
Firmware	100	Storing/Recalling of instrument settings	34
Hour minutes	105	U	
Key brightness	107	Unpacking the instrument	18
Key fallback time	107	Update	
Power up	111	Firmware	100
Remote control interface	101	USB	120
Save date time	104	Interface	118
Socket	117	USB B	
Sound		Connector	31
Access	105	USB connection	
Miscellaneous functions	105	USB TMC	118
Special characters		USB VCP	118
SCPI syntax	194	USB connector	
Special numeric values		Front panel	29
SCPI parameters	192	USB mode	
Standby		Access	118
Front panel	29	USB VCP	120
Statistic function	39	User manual	16
Statistics		Utility keys	
Access	72, 94	Front panel keys	49
How to: set	72	V	
Status bar information		VISA	113
Channel status	37	Resource string	124
Device status	37	Voltage	53
Status byte			
Remote	133, 135		
Status information			
Notifications	180		