



PicoSource[®] AS108

8 GHz Agile Synthesizer

User's Guide



致力于电子测试、维护领域!

Contents

1 Introduction	1
2 Safety information	2
3 Software license conditions	3
4 Trademarks	4
5 Warranty	5
6 Getting started	6
1 Device selection and demo mode	6
2 Windows 7 setup	7
7 Operation	8
1 Carrier Wave tab	8
2 Sweep/Hop tab	9
3 Arbitrary tab	10
1 List file format	11
2 Complex modulation	11
4 Settings tab	12
5 Trigger output	13
6 Trigger input	13
8 Performance verification and maintenance	14
1 Routine maintenance	16

1 Introduction

The PicoSource AS108 is a USB-controlled signal generator capable of operation over the range of 300 kHz to 8 GHz. Figure 2 shows the arrangement used to generate the output signal. A Fractional-N reference is used to generate a 429.4967296 MHz signal as the reference for the DDS signal generator chip. This allows the DDS to produce an output with a precise 0.1 Hz resolution. This output is then multiplied to cover the range 4 to 8 GHz using a conventional PLL.



Figure 1 – AS108

The entire 300 kHz to 8 GHz band is covered by an arrangement that switches in or bypasses the PLL multiplier and dividers. The output level is set and maintained by means of an AGC loop as shown in Figure 2.

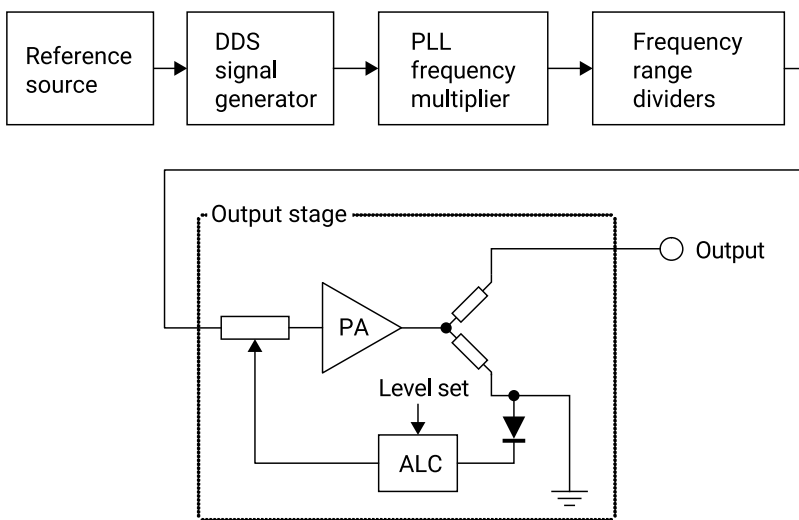

Figure 2 - Simplified block diagram of the AS108

The instrument supports external AM and FM modulation. This is done by sampling and digitizing the analog modulation input. The outcome is then used to adjust the output level (for AM) or the DDS output frequency.

Various trigger modes are supported. A trigger input and output are provided on the rear panel (see Figure 3). In addition, an output with the internal 10 MHz reference is available. This allows phase synchronization with external sources. Similarly, a 10 MHz reference input is provided allowing the internal reference to be locked to an external 10 MHz source.



Figure 3 - Rear panel of the AS108

2 Safety information

To prevent possible electrical shock, fire, personal injury, or damage to the product, carefully read the safety warnings in the *PicoSource AS108 Quick Start Guide* before attempting to install or use the product. In addition, follow all generally accepted safety practices and procedures for working with and near electricity.

3 Software license conditions

The material contained in this release is licensed, not sold. Pico Technology grants a license to the person who installs this software, subject to the conditions listed below.

Access. The licensee agrees to allow access to this software only to persons who have been informed of these conditions and agree to abide by them.

Usage. The software in this release is for use only with Pico products or with data compiled using Pico products.

Copyright. Pico Technology claims the copyright of, and retains the rights to, all material (software, documents etc.) contained in this release. You may copy and distribute the entire release in its original state, but must not copy individual items within the release other than for backup purposes.

Liability. Pico Technology and its agents shall not be liable for any loss, damage or injury, howsoever caused, related to the use of Pico Technology equipment or software, unless excluded by statute.

Fitness for purpose. As no two applications are the same, Pico Technology cannot guarantee that its equipment or software is suitable for a given application. It is your responsibility, therefore, to ensure that the product is suitable for your application.

Mission-critical applications. This software is intended for use on a computer that may be running other software products. For this reason, one of the conditions of the license is that it excludes use in mission-critical applications, for example life support systems.

Viruses. This software was continuously monitored for viruses during production, but you are responsible for virus-checking the software once it is installed.

Support. If you are dissatisfied with the performance of this software, please contact our technical support staff, who will try to fix the problem within a reasonable time. If you are still dissatisfied, please return the product and software to your supplier within 14 days of purchase for a full refund.

Upgrades. We provide upgrades, free of charge, from our web site at www.picotech.com. We reserve the right to charge for updates or replacements sent out on physical media.

4 Trademarks

Pico Technology, *PicoSource* and *PicoScope* are trademarks of Pico Technology Limited, registered in the United Kingdom and other countries.

PicoSynth is a trademark of Pico Technology Limited.

PicoScope and *Pico Technology* are registered at the U.S. Patent and Trademark Office.

5 Warranty

Pico Technology **warrants** upon delivery, and for a period of three years unless otherwise stated from the date of delivery, that the Goods will be free from defects in material and workmanship.

Pico Technology shall not be liable for a breach of the warranty if the defect has been caused by fair wear and tear, willful damage, negligence, abnormal working conditions or failure to follow Pico Technology's spoken or written advice on the storage, installation, commissioning, use or maintenance of the Goods or (if no advice has been given) good trade practice; or if the Customer alters or repairs such Goods without the written consent of Pico Technology.

6 Getting started

To use the PicoSource AS108 for the first time:

- Download the PicoSynth 2 software, or copy it from the USB stick if provided.
- Right-click on the software package and click "Run As Administrator".
- Connect the AS108 to the PC using the blue USB cable supplied:
- Plug the power supply (included) into the mains and connect its DC output to the AS108.
- Switch on the AS108 at the power switch on the rear panel:
- Wait while Windows installs the driver. This should take only a few seconds.
- Run the PicoSynth 2 software by clicking the shortcut on your desktop:

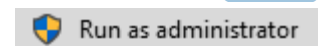

6.1 Device selection and demo mode

When PicoSynth 2 starts, it will present a list of attached devices as well as a "Demo" device. Select the Demo device if you wish to try the software without the need to connect a PicoSource AS108.

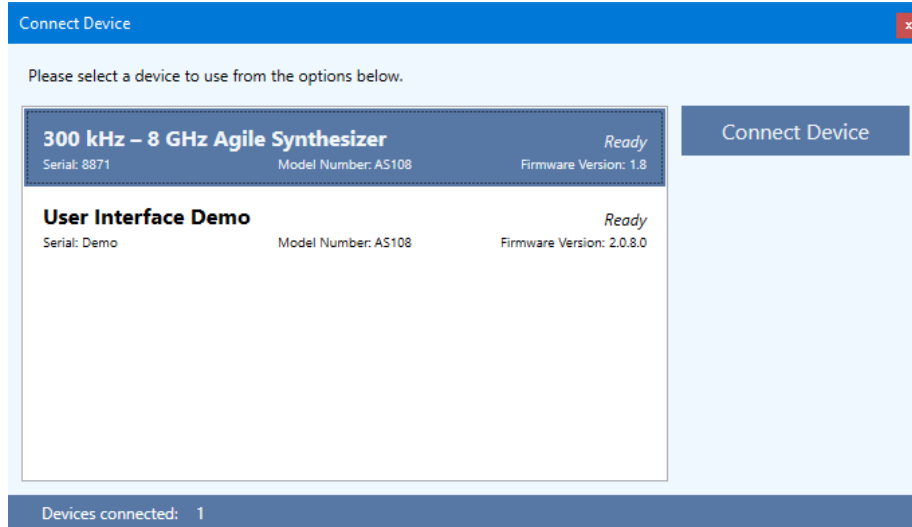

6.2 Windows 7 setup

The following extra steps are required when installing on Windows 7.

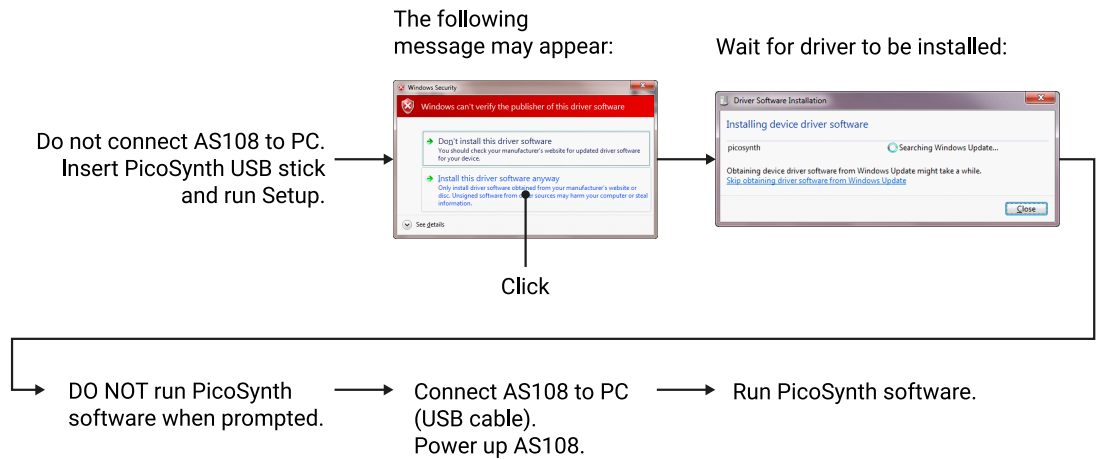

7 Operation

The instrument is operated through the PicoSynth 2 software. This allows programming of the various instrument modes.

Selecting any of the first three tabs (**Carrier Wave**, **Sweep/Hop** and **Arbitrary**) immediately switches the AS108 to that mode, and will generate a signal if the **Output** switch for that mode is set to **ON**.

7.1 Carrier Wave tab

Carrier Wave mode generates a sine wave with optional AM, FM or PM modulation.

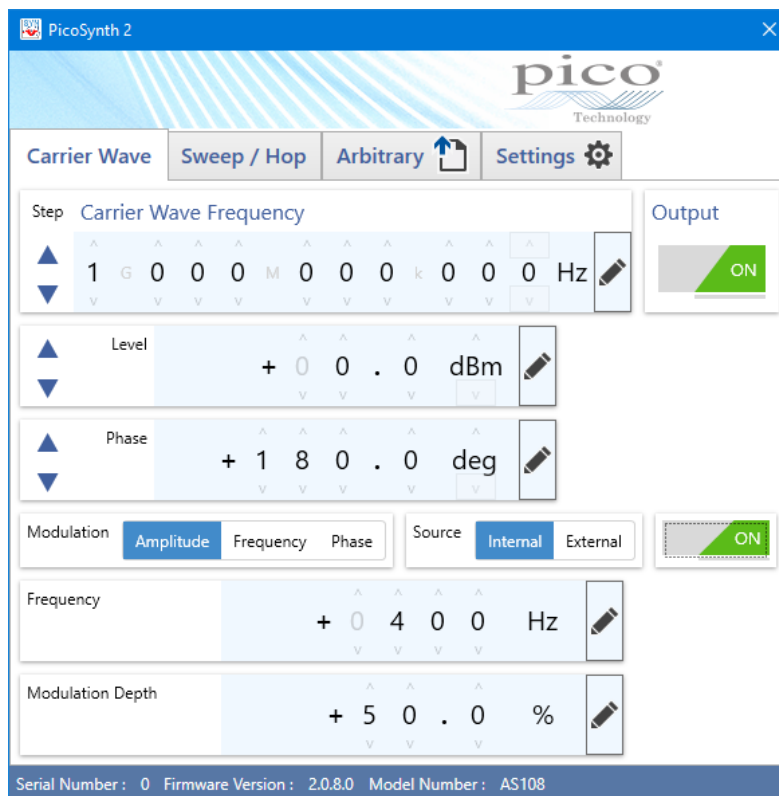

Carrier Wave Frequency: the centre frequency of the output wave.

Level: the output amplitude in mW, dBm, V p-p or V RMS.

Phase: the output phase, in degrees, degrees \pm or radians, relative to the reference output on the rear panel.

Modulation: the type of modulation (AM, FM or PM) required. If no modulation is required, set the modulation switch to **OFF**. Set the switch to **ON** to enable modulation.

Source: the origin of the modulating signal (the internal modulation sine wave generator, or the **FM/AM Input** connector on the front panel).

Frequency (internal modulation source only): the frequency of the internal modulation generator.

Modulation Depth (AM mode): the percentage of modulation from 0% (no modulation) to 100% (maximum possible modulation) for a full-scale modulating signal input.

Modulation Deviation (FM mode): the maximum frequency excursion from the centre frequency for a full-scale modulation input.

Modulation Deviation (PM mode): the maximum phase deviation from 0° (no modulation) to 180° (maximum possible modulation) for a full-scale modulating signal input.

7.2 Sweep/Hop tab

Sweep/Hop mode generates a linear sweep between two specified states (the *end points*) or a hop (alternation) between the two end points.

To generate a nonlinear sweep, use **Arbitrary** mode.

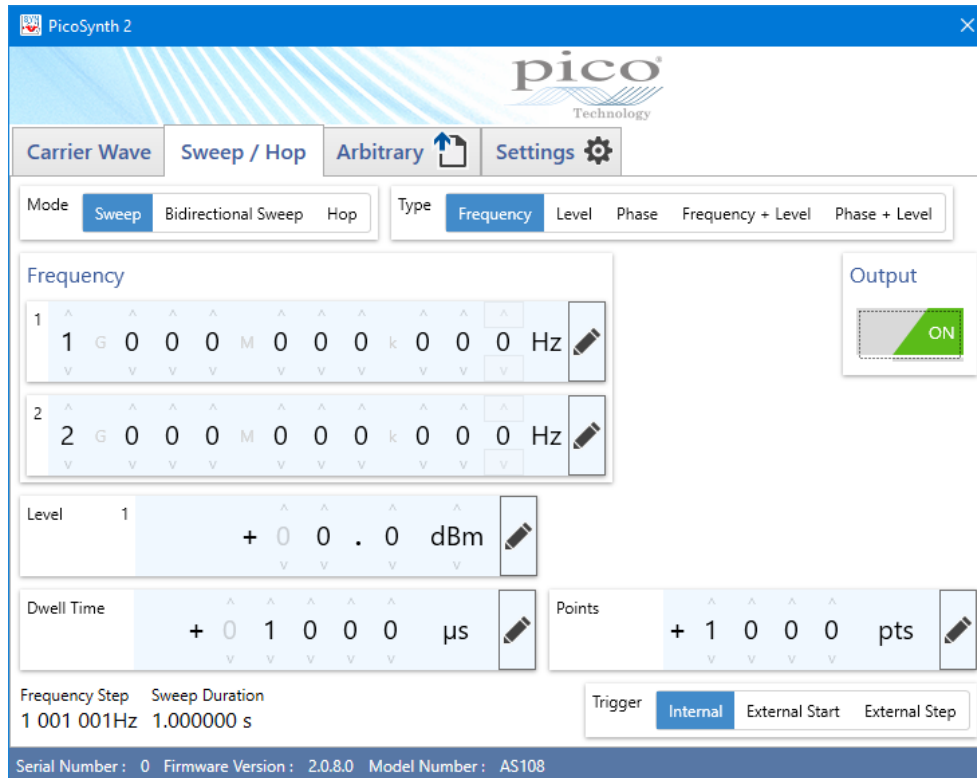

Mode: **Sweep** generates a linear sweep between the two end points. **Bidirectional Sweep** generates a linear sweep in one direction followed by a linear sweep in the opposite direction. **Hop** alternates between the two end points.

Type: indicates which parameters to sweep or hop. The other parameters will remain constant.

Output: set to **ON** to enable the signal output.

Dwell Time: the period of time between steps in the sweep or hop. Adjustable between 26 μs and 65 500 μs with a 1 μs resolution.

Points: the number of points in the sweep. The interval between the two end points will be divided equally into this number of points for each parameter.

Trigger: **Internal** - each sweep starts when the previous sweep ends.

External Start - the generator waits for a pulse on the external trigger input on the rear panel before starting each sweep.

External Step - the generator waits for a pulse on the external trigger input on the rear panel before advancing to the next point in the sweep.

Note: The dwell time acts as a trigger hold-off: trigger events that occur during the dwell time are ignored. Therefore, in most circumstances, it is advisable to use the lowest dwell time when using **External** trigger modes.

7.3 Arbitrary tab

Arbitrary mode generates a sequence of level/frequency/phase points defined by a text file.



Open File: Load a text file containing the arbitrary sequence of points. The **Arbitrary List** panel will show a summary of the file contents: the sequence mode, the number of points and the calculated duration of the sequence.

Output: Set to **ON** to enable the Arbitrary List generator output.

Frequency, Level or Phase: One of three possible output parameters, whichever is not specified in the Arbitrary List file.

Dwell Time: The period of time between steps in the arbitrary sequence. Adjustable between 26 μs and 65 500 μs with a 1 μs resolution.

Trigger: **Internal** - Each sequence starts when the previous sequence ends.

External Start - The generator waits for a pulse on the external trigger input on the rear panel before starting the sequence .

External Step - The generator waits for a pulse on the external trigger input on the rear panel before advancing to the next step in the sequence.

Note: The dwell time acts as a trigger hold-off: trigger events that occur during the dwell time are ignored. Therefore, in most circumstances, it is advisable to use the lowest dwell time when using **External** trigger modes.

7.3.1 List file format

Frequency sweep example:

```
Level, Frequency, Phase, Dwell, Mode
0, 10000001, 0, 1234, FrequencyAndLevel
0, 10000002, 0, ,
0, 10000003, 0, ,
...
0, 10008999, 0, ,
0, 10009000, 0, ,
```

- Level is specified in dBm and must be in the range -15 dBm to +15 dBm or +6 dBm if the frequency is above 3 GHz.
- Frequency is specified in MHz.
- Phase is specified in degrees and must be within the range 0° to 360°.
- Dwell time is specified in μ s.
- Mode indicates which parameters are swept and which are constant. The options are:
PhaseAndLevel
FrequencyAndLevel

7.3.2 Complex modulation

In the case of the complex sweep, the dwell time range is 27 μ s to 65500 μ s. Consider the possible effects of the finite settling times when using very short dwell times. It is advisable to test any plan to ensure correct transitions are achieved.

$$\text{Carrier} = I.\sin(\omega t) + R.\cos(\omega t)$$

We can rewrite as follows:

$$\text{Carrier} = K.\sin(\omega t + \delta)$$

$$\text{Carrier} = K.\sin(\omega t).\cos(\delta) + K.\cos(\omega t).\sin(\delta)$$

So, by inspection we have;

$$I^2 + R^2 = K^2(\cos^2(\delta) + \sin^2(\delta))$$

$$\boxed{\begin{aligned} K &= \sqrt{I^2 + R^2} \\ \delta &= a \tan\left(\frac{R}{I}\right) \end{aligned}}$$

The values of K and δ are the amplitude and phase values of each sample point in the sweep plan. The user should note that the acceptable phase range in the plan is 0° to 360°. So, negative values need to be converted. Also, the amplitude values in the plan must be in dBm. Measured characteristics (using a 300 MHz carrier) obtained using this approach are shown below. The constellation shown is with no receive filter.

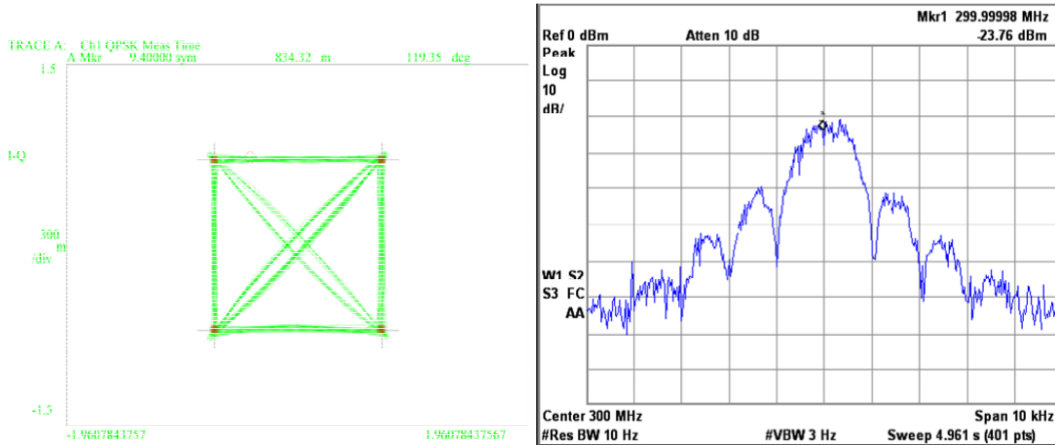
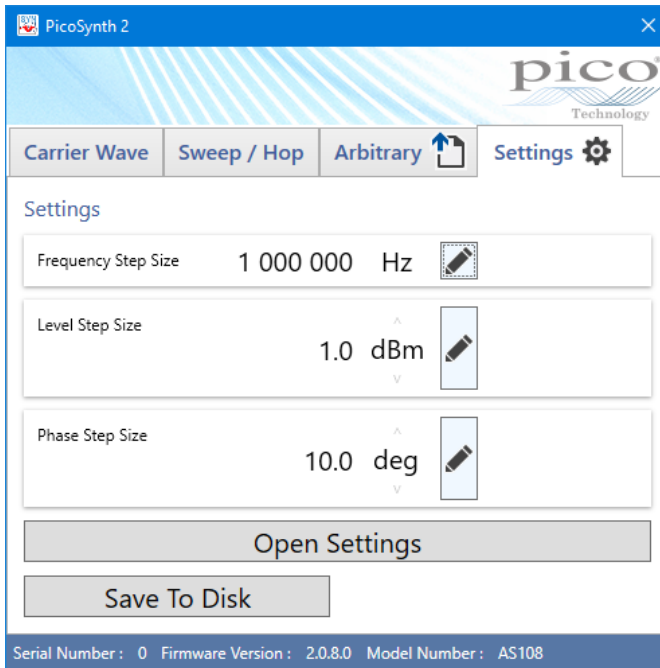

Figure 9 - Constellation and spectrum of the signal generator emulating QPSK

7.4 Settings tab

The **Settings** tab contains various configuration options.



Frequency Step Size: The frequency step used by the **Frequency Up/Down** buttons in **Carrier Wave** mode.

Level Step Size: The level step used by the **Level Up/Down** buttons in **Carrier Wave** mode.

Phase Step Size: The phase step used by the **Phase Up/Down** buttons in **Carrier Wave** mode.

Open Settings: Open a .sas file containing PicoSynth 2 settings.

Save To Disk: Save the PicoSynth 2 settings as a .sas file for later retrieval.

Save To Device: This saves current settings as the next power-up state for the synthesizer and enables stand-alone operation, which allows the device to generate an output without the need for a USB connection.

CAUTION. Settings that include **Output ON** may cause damage if the connected load is changed. Where the connected load could change, use only **Output OFF** settings when saving to the device.

The device will generate a signal according to these settings when next powered on.

7.5 Trigger output

The **Trigger** output on the rear panel goes high (positive, 5 V logic level) at the start of each sweep and goes low at the end of each sweep. Note that there is small dwell time between sweeps when the trigger output remains low.

7.6 Trigger input

The signal applied to this input is sampled by an internal 5 MHz clock. The point at which the trigger actually occurs is thus subject to a $\pm 100 \mu\text{s}$ uncertainty.

8 Performance verification and maintenance

It is recommended that the instrument is checked annually for safety and compliance with the stated electrical specification. Table 1 shows the parameters that should be checked as part of the calibration process. Note that the ventilation inlets should be checked as described later.

Test	Limit	Conditions	Comment
Frequency accuracy	± 5 ppm	Test at 0.3, 100, 1000, 4000 and 8000 MHz CW, 0 dBm output	See Figure 10. Test pass also confirms PLL and AGC lock.
Output level accuracy	± 1 dB	-15, -5, +5, +15 dBm settings tested at 1, 100, 4000 and 8000 MHz	See Figure 11
Trigger output	> 3 V output	1000 to 1200 MHz sweep, 100 μs dwell, 100 MHz step	Check trigger output with oscilloscope. See Figure 14.
PLL loop bandwidth	Falls within mask	6 GHz, +8 dBm output	Spectrum analyzer set to 500 kHz span with 1 kHz resolution bandwidth
Lock to external reference	± 1 Hz	1 GHz CW, 0 dBm	Connect frequency counter's 10 MHz reference output to 10 MHz input (see Figure 10).

Table 1 - Suggested annual instrument verification / calibration schedule

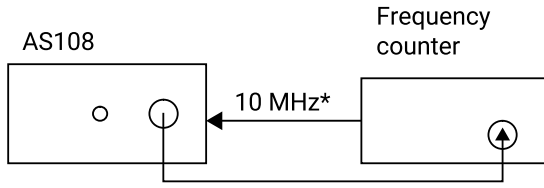

* Connect 10 MHz reference to check external reference lock. Reference must be within ± 5 ppm of exact value.

Figure 10 - Use a frequency counter to check frequency accuracy

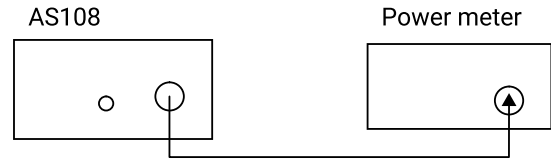
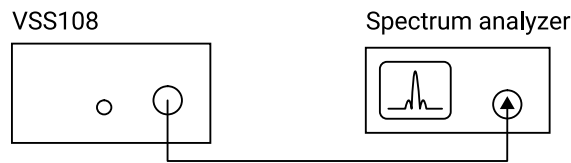

Figure 11 - Use a power meter to check level accuracy



Set to: 6 GHz, +8 dBm

Set to: 6 GHz, 500 kHz span, 1 kHz bandwidth

Figure 12 - Use a spectrum analyzer to check PLL bandwidth

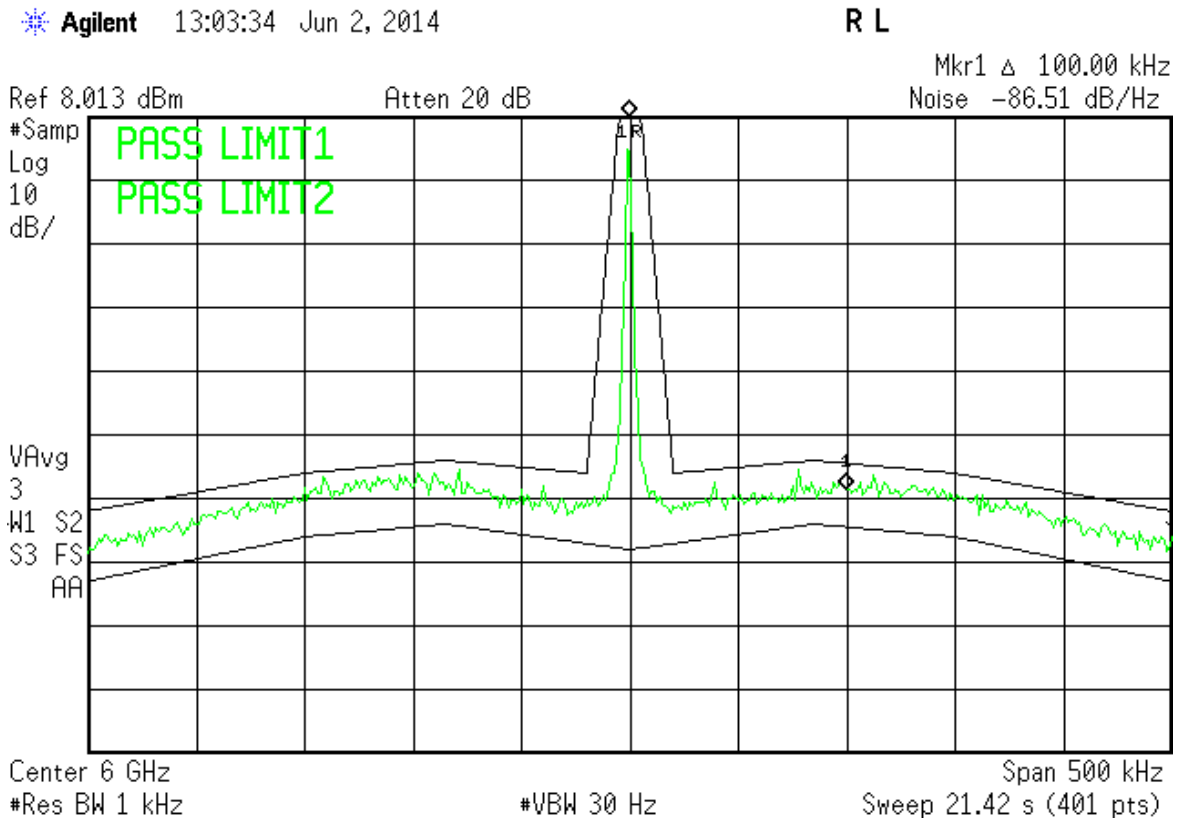
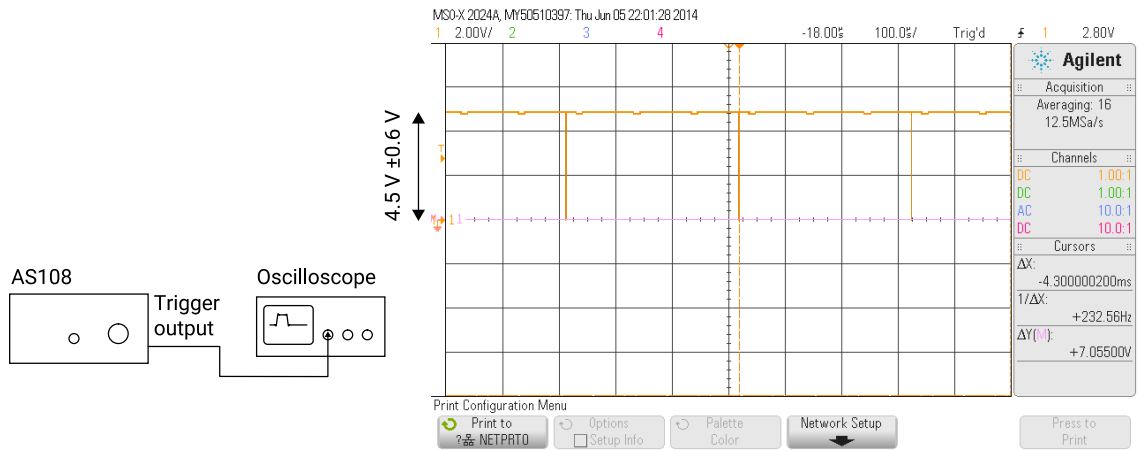

Figure 13 - PLL bandwidth check using spectrum analyzer plot



8.1 Routine maintenance

Ventilation grilles

Check that all ventilation grilles at the back of the unit are clear of any debris, dust or any other material that may impede the flow of air.

Front panel connector

Inspect the main RF output N-type connector routinely for signs of damage or dirt. N-type connectors are generally quite rugged, but taking extra care will ensure a long service life.



北京海洋兴业科技股份有限公司 (证券代码: 839145)

北京市西三旗东黄平路19号龙旗广场4号楼 (E座) 906室

电话: 010-62176775 62178811 62176785

企业QQ: 800057747 维修QQ: 508005118

企业官网: www.hyxyyq.com

邮编: 100096

传真: 010-62176619

邮箱: market@oitek.com.cn

购线网: www.gooxian.com



扫描二维码关注我们
查找微信公众号: 海洋仪器