



Instructions

A621
1000 Amp AC Current Probe
070-8882-02



070888202

Copyright © Tektronix, Inc. All rights reserved.

Tektronix products are covered by U.S. and foreign patents, issued and pending. Information in this publication supercedes that in all previously published material. Specifications and price change privileges reserved.

Tektronix, Inc., P.O. Box 500, Beaverton, OR 97077

TEKTRONIX and TEK are registered trademarks of Tektronix, Inc.

Warranty 2

Tektronix warrants that this product will be free from defects in materials and workmanship for a period of one (1) year from the date of shipment. If any such product proves defective during this warranty period, Tektronix, at its option, either will repair the defective product without charge for parts and labor, or will provide a replacement in exchange for the defective product. Parts, modules and replacement products used by Tektronix for warranty work may be new or reconditioned to like new performance. All replaced parts, modules and products become the property of Tektronix.

In order to obtain service under this warranty, Customer must notify Tektronix of the defect before the expiration of the warranty period and make suitable arrangements for the performance of service. Customer shall be responsible for packaging and shipping the defective product to the service center designated by Tektronix, with shipping charges prepaid. Tektronix shall pay for the return of the product to Customer if the shipment is to a location within the country in which the Tektronix service center is located. Customer shall be responsible for paying all shipping charges, duties, taxes, and any other charges for products returned to any other locations.

This warranty shall not apply to any defect, failure or damage caused by improper use or improper or inadequate maintenance and care. Tektronix shall not be obligated to furnish service under this warranty a) to repair damage resulting from attempts by personnel other than Tektronix representatives to install, repair or service the product; b) to repair damage resulting from improper use or connection to incompatible equipment; c) to repair any damage or malfunction caused by the use of non-Tektronix supplies; or d) to service a product that has been modified or integrated with other products when the effect of such modification or integration increases the time or difficulty of servicing the product.

THIS WARRANTY IS GIVEN BY TEKTRONIX WITH RESPECT TO THE PRODUCT IN LIEU OF ANY OTHER WARRANTIES, EXPRESS OR IMPLIED. TEKTRONIX AND ITS VENDORS DISCLAIM ANY IMPLIED WARRANTIES OF MERCHANTABILITY OR FITNESS FOR A PARTICULAR PURPOSE. TEKTRONIX' RESPONSIBILITY TO REPAIR OR REPLACE DEFECTIVE PRODUCTS IS THE SOLE AND EXCLUSIVE REMEDY PROVIDED TO THE CUSTOMER FOR BREACH OF THIS WARRANTY. TEKTRONIX AND ITS VENDORS WILL NOT BE LIABLE FOR ANY INDIRECT, SPECIAL, INCIDENTAL, OR CONSEQUENTIAL DAMAGES IRRESPECTIVE OF WHETHER TEKTRONIX OR THE VENDOR HAS ADVANCE NOTICE OF THE POSSIBILITY OF SUCH DAMAGES.

Contacting Tektronix

Phone	1-800-833-9200*
Address	Tektronix, Inc. Department or name (if known) 14200 SW Karl Braun Drive P.O. Box 500 Beaverton, OR 97077 USA
Web site	www.tektronix.com
Sales support	1-800-833-9200, select option 1*
Service support	1-800-833-9200, select option 2*
Technical support	www.tektronix.com/support 1-800-833-9200, select option 3* 6:00 a.m. – 5:00 p.m. Pacific Standard Time

*_____

This phone number is toll free in North America. After office hours, please leave a voice mail message.

Outside North America, contact a Tektronix sales office or distributor; see the Tektronix web site for a list of offices.

General Safety Summary

Review the following safety precautions to avoid injury and prevent damage to this product or any products connected to it. To avoid potential hazards, use this product only as specified.

Only qualified personnel should perform service procedures.

To Avoid Fire or Personal Injury

Connect and Disconnect Properly. Connect the probe output to the measurement instrument before connecting the probe to the circuit under test. Disconnect the probe input and the probe ground from the circuit under test before disconnecting the probe from the measurement instrument.

Observe All Terminal Ratings. To avoid fire or shock hazard, observe all ratings and markings on the product. Consult the product manual for further ratings information before making connections to the product.

Do Not Operate Without Covers. Do not operate this product with covers or panels removed.

Avoid Exposed Circuitry. Do not touch exposed connections and components when power is present.

Do Not Operate With Suspected Failures. If you suspect there is damage to this product, have it inspected by qualified service personnel.

Do Not Operate in Wet/Damp Conditions.

Do Not Operate in an Explosive Atmosphere.

Keep Product Surfaces Clean and Dry.

Safety Terms and Symbols

Terms in This Manual. These terms may appear in this manual:



WARNING. *Warning statements identify conditions or practices that could result in injury or loss of life.*



CAUTION. *Caution statements identify conditions or practices that could result in damage to this product or other property.*

Terms on the Product. These terms may appear on the product:

DANGER indicates an injury hazard immediately accessible as you read the marking.

WARNING indicates an injury hazard not immediately accessible as you read the marking.

CAUTION indicates a hazard to property including the product.

Symbols on the Product. These symbols may appear on the product:



CAUTION
Refer to Manual





Double
Insulated

Product Description

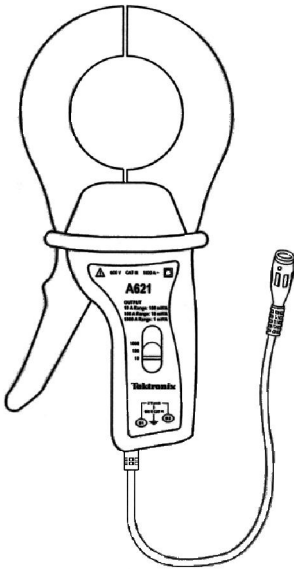
The Tektronix A621 current probe enables the display of current waveforms up to 1000 amps RMS on Tektronix TDS, TAS, or general purpose oscilloscopes. The A621 is especially useful where the display and measurement of distorted current waveforms and harmonics is required. The A621 is also compatible with DMMs by using the BNC-to-banana plug adapter (recommended accessory, see page 17 for more information).



<p style="text-align: center;">I</p> 	<p>Current Flow Symbol</p> <p>This arrow shows the probe's polarity convention for measuring current flowing from positive to negative.</p>
<p>1000 100 10</p> 	<p>Range Switch</p> <p>Slide to select the measurement range of the probe- 10/100/1000 A.</p>

Operating Basics



WARNING. Do not clamp the probe onto circuits with voltages greater than 600 VAC. Personal injury or damage to the probe may result.

Always connect the probe to the instrument before clamping onto the circuit under test.

1. Connect the probe BNC connector to the oscilloscope input. Start by setting the oscilloscope channel vertical coupling to AC volts, the vertical deflection to 0.1 V/div, and the probe to 1 mV/A.
2. Connect the probe to the circuit by opening the jaws and clamping around the conductor. See Figure 1. Note: Clamping around both the “hot” and neutral wires may give you a zero reading.

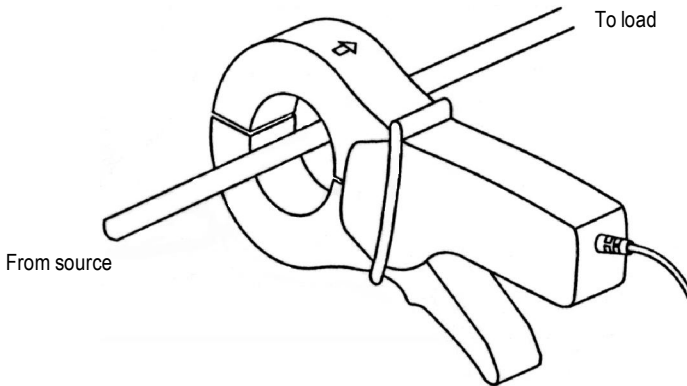

Figure 1: Connecting the A621

(Remember to unclamp the probe from the conductor before disconnecting it from your meter or instrument.)

- Adjust the probe range and scope channel as necessary to get a clear view of the signal.

The current drawn by some devices will look much different than that of others. While the RMS current may be low, the momentary peaks may be quite high. Figure 2 shows the difference between the line current drawn by a resistive load and a motor controller.

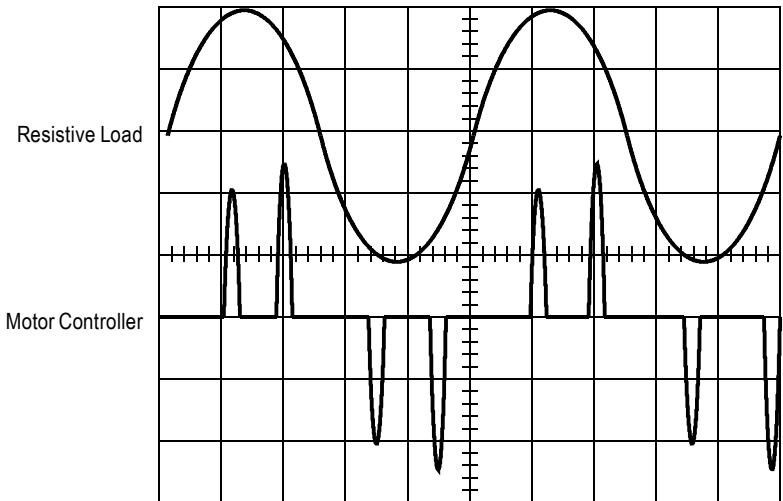

Figure 2: Typical Current Waveforms

If you are using the A621 with a multimeter, use the BNC-to-banana adapter (recommended accessory) to connect the probe. Connect the black lead to the meter COM, and the red lead to the $V\Omega$ input. Set the meter to the AC Volts position.

To increase the measurement sensitivity of the A621, loop additional turns of the wire under test through the jaws. See Figure 3. The sensitivity of the A621 will be multiplied times the number of loops in the jaws. For example: $10 \text{ mV/A} \times 4 \text{ turns} = 40 \text{ mV/A}$.

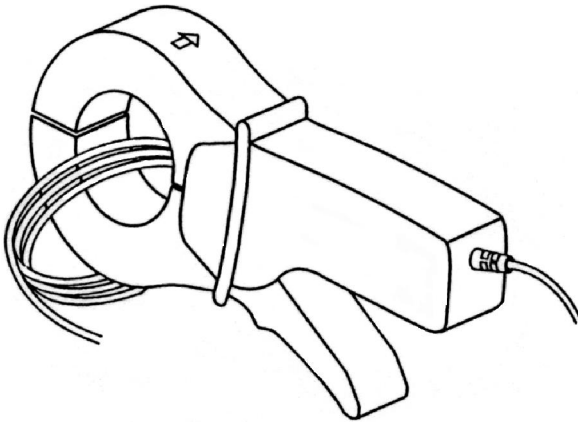

Figure 3: Increasing the A621 Sensitivity

Specifications

These characteristics apply to an A621 probe installed on a Tektronix TDS320 oscilloscope. The oscilloscope must be warmed up for at least 20 minutes and be in an environment within the limits in Table 3.

Table 1: Electrical Characteristics

Output	1/10/100 mV/A
Accuracy	$\pm 2\%$ at 1 mV/A and 10 mV/A $\pm 3\%$ at 100 mV/A
Maximum Working Current	2000 A _{PEAK} at 1 mV/A 1000 A _{RMS} at 1 mV/A 200 A _{PEAK} at 10 mV/A 20 A _{PEAK} at 100 mV/A
Maximum Working Voltage	600 V CAT III
Frequency Range	5 Hz to 50 kHz

Typical Response Curves

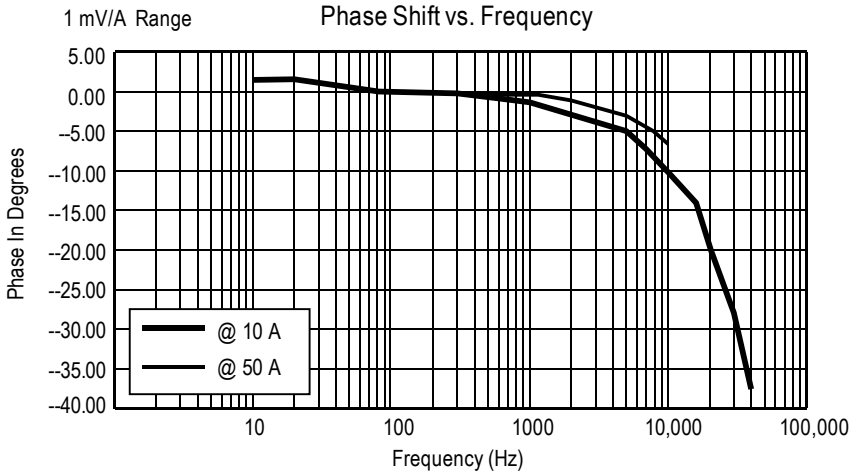
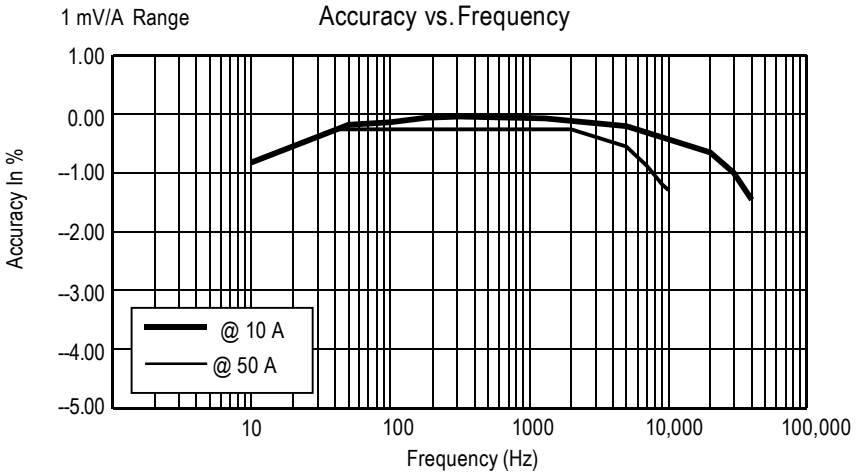

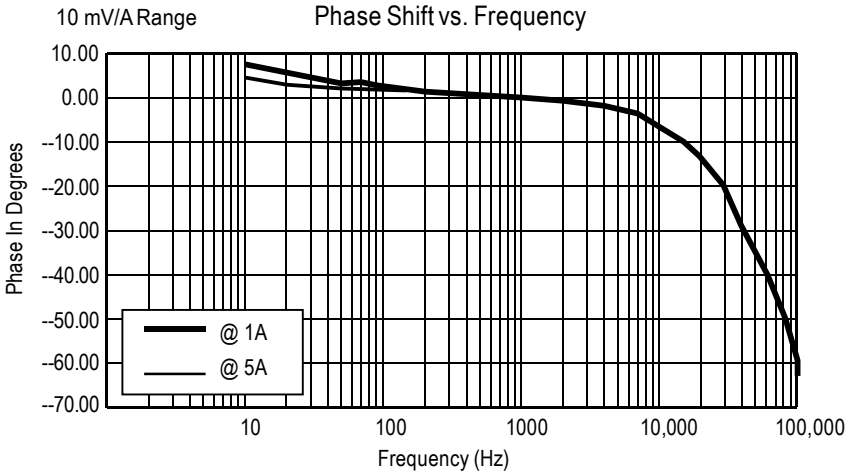
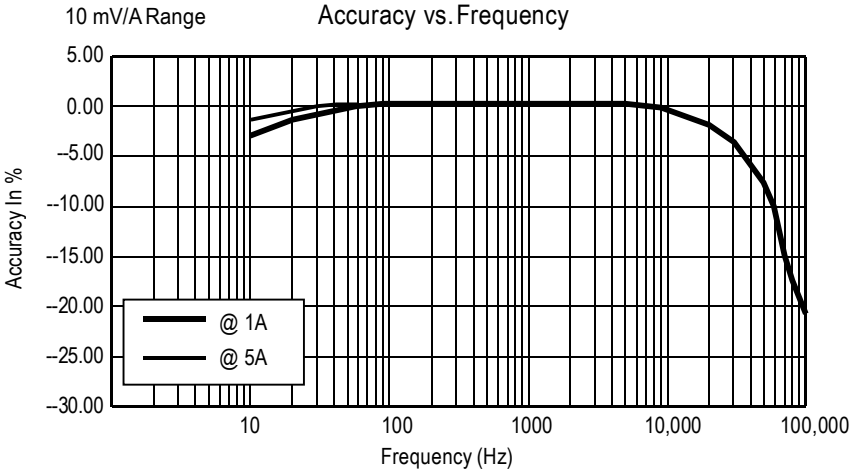

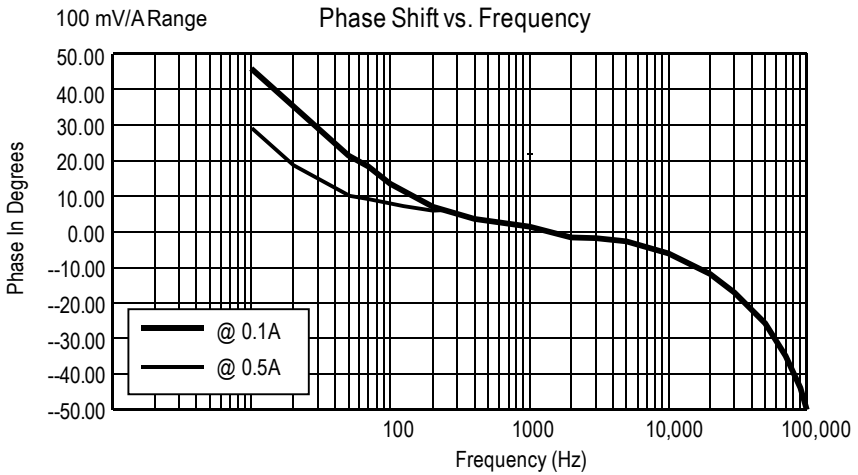
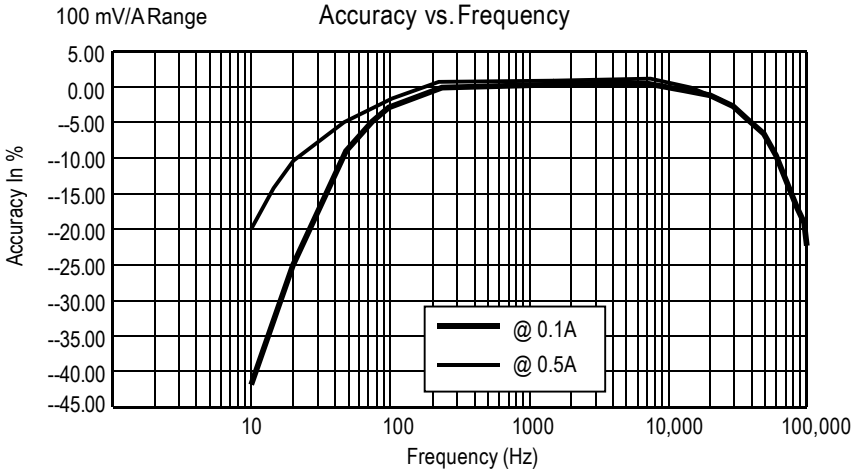

Table 2: Physical Characteristics

Dimensions	206 mm x 48 mm x 105 mm (8.11 x 1.89 x 4.13 inches)
Maximum Conductor Size	54 mm (2.13 inches)
Cable Length	1.5 m (5 feet)
Weight	650 g (1.43 lb)

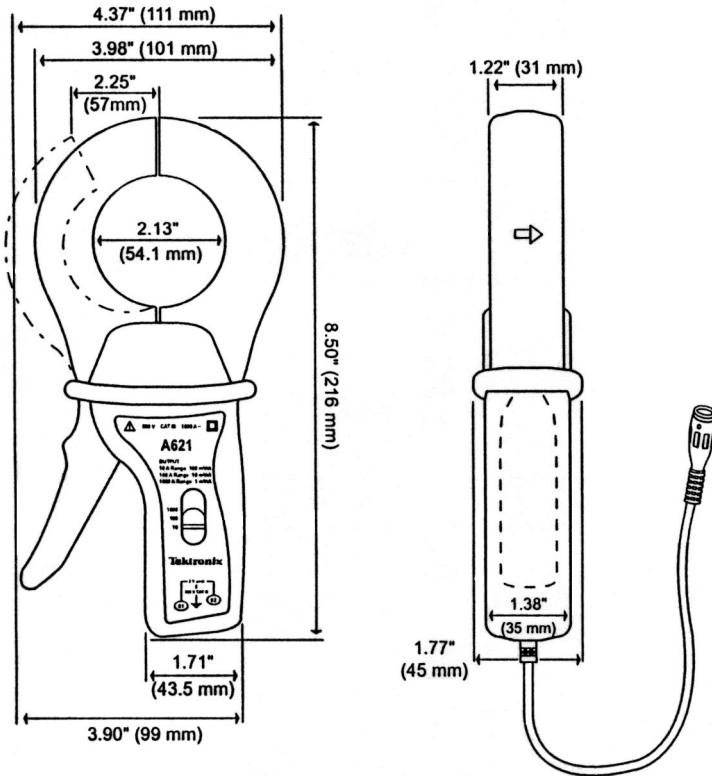

Figure 4: Physical dimensions

Table 3: Environmental Characteristics

Temperature	
Working	0°C to +50°C (+32° to +122°F)
Storage	-20°C to +80°C (-4° to +176°F)
Humidity	0° C to 40° C, 95% humidity 40° C to 50° C, 45% humidity

Table 4: Certifications and compliances

EC Declaration of Conformity	<p>Compliance was demonstrated to the following specification as listed in the Official Journal of the European Communities:</p> <p>Low Voltage Directive 73/23/EEC, as amended by 93/68/EEC</p> <p>EN 61010-1/A2:1995 Safety requirements for electrical equipment for measurement, control, and laboratory use.</p> <p>EN 61010-2-032:1995 Particular requirements for hand-held current clamps for electrical measurement and test equipment.</p>
Installation (Overvoltage) Category	<p>Terminals on this product may have different installation (overvoltage) category designations. The installation categories are:</p> <p>CAT III Distribution-level mains (usually permanently connected). Equipment at this level is typically in a fixed industrial location.</p> <p>CAT II Local-level mains (wall sockets). Equipment at this level includes appliances, portable tools, and similar products. Equipment is usually cord-connected.</p> <p>CAT I Secondary (signal level) or battery operated circuits of electronic equipment.</p>

Table 4: Certifications and compliances (cont.)

Pollution Degree 2	Do not operate in environments where conductive pollutants may be present.
U.S. Nationally Recognized Testing Laboratory Listing	UL3111-1, First Edition & UL3111-2-032, First Edition CSA C22.2 No. 1010.1-92 & CAN/CSA C22.2 No. 1010.2.031-94 IEC61010-1/A2 EN 61010-2-032 Pollution Degree 2

Performance Verification

This procedure verifies that the A621 performs as specified. It can also be an acceptance check. There are no A621 adjustments. This procedure is valid when:

- The system is operated in an environment that conforms to the A621 environmental specifications (0° C to 50° C unless otherwise stated).
- The oscilloscope is set to DC coupling, normal triggering.

The performance verification procedure requires the test equipment in Table 5, or its equivalent. If different equipment is substituted, control settings or test equipment setup may need to be altered.

The performance verification consists of an accuracy check of the probe ranges.

Warm up the test equipment at least 20 minutes to stabilize it before performing the checks.

Table 5: Test Equipment Required for Performance Verification

Item	Minimum Requirements	Recommended Example
Oscilloscope	1 M Ω input, general purpose oscilloscope	Tektronix TAS/TDS series
Signal Generator	60 Hz Sine Wave, ≥ 50 mA _{RMS} into $< 1 \Omega$	Tektronix FG 501A ¹ , FG 504 ¹ or equivalent
Multimeter	≥ 0.5 A max. input current, accuracy $\leq 0.6\%$ of reading on AC Current measurement at 60 Hz	Tektronix DM 504A ¹ or equivalent
Current Loop, 100 turn	100 turns coated wire, 20 AWG (≈ 0.9 mm), loop diameter 7.5 cm (3 in), alligator clips on ends	See procedure
18 inch banana jack-to-banana jack patch cords, three required		Tektronix part numbers: 012-0031-00 012-0039-00

¹Requires Tektronix TM 500 Series or Tektronix TM 5000 Series Power Module

100 Turn Current Loop



CAUTION. *It is not recommended that a coil with greater than 100 turns be made. Magnetic fields are produced that may cause a malfunction in heart pacemakers, or damage to sensitive equipment. Coil currents in excess of 0.2 Amperes are not recommended.*

For the accuracy check you will need a simple current loop. Wind 100 turns of 20 AWG (≈ 0.9 mm diameter) coated wire around a cylindrical form approximately 7.5 cm (3 inches) in diameter.

NOTE. *Be sure the current loop has exactly 100 turns. A significant error will result for each extra or missing turn.*

AC Accuracy Check

1. Connect the 100 turn current loop, the multimeter current inputs, and the signal generator output in series, using the patch cords and adapter. Set the multimeter to display AC_{RMS} current. See Figure 5.

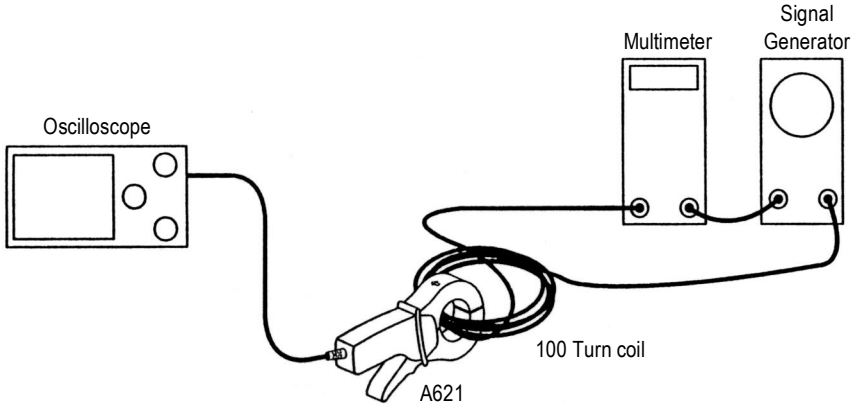

Figure 5: Setup for Maximum Input Current and Accuracy Checks

2. Adjust the signal generator output to between 49 mA_{RMS} and 51 mA_{RMS} as measured on the multimeter.
3. Connect the A621 to the oscilloscope, and make the following oscilloscope settings:
 - time base to $5 \text{ ms} / \text{div}$.
 - vertical deflection to $500 \text{ mV} / \text{div}$.
 - coupling to DC
4. Set the A621 sensitivity switch to $100 \text{ mV} / \text{A}$ and center the trace on the oscilloscope screen.
5. Clamp the A621 around the 100 turn current loop.
6. If necessary, readjust the signal generator output to read between 49 mA_{RMS} and 51 mA_{RMS} on the multimeter.

7. Check that the waveform peak to peak amplitude measures $1.4 \pm 0.1 V_{P-P}$ on the oscilloscope.
8. Continue to check the probe accuracy using the parameters in Table 6.

Table 6: AC Accuracy Check Parameters

Step	Probe Range	Oscilloscope V/div setting	Multimeter reading	Oscilloscope display
1.	100 mV/A	200 mV/div.	50 ± 1 mA	$1.4 \pm 0.1 V_{P-P}$
2.	10 mV/A	20 mV/div.	50 ± 1 mA	$140 \pm 10 mV_{P-P}$
3.	1 mV/A	2 mV/div.	50 ± 1 mA	$14 \pm 1 mV_{P-P}$

Maintenance

Cleaning

To clean the probe body, use a soft cloth dampened in a solution of mild detergent and water. To clean the core, open the jaw and clean the exposed core surfaces with a cotton swab dampened with isopropyl alcohol (isopropanol) or ethyl alcohol (fotocol or ethanol). Lubricate the jaws mating surfaces with a light oil.

Do not use chemicals containing benzine, benzene, toluene, xylene, acetone, or similar solvents.

Do not immerse the probe in liquids or use abrasive cleaners.

Preparation for Shipment

If the original packaging is unfit for use or not available, use the following packaging guidelines:

1. Use a corrugated cardboard shipping carton having inside dimensions at least one inch greater than the probe dimensions. The box should have a carton test strength of at least 200 pounds.
2. Put the probe into a plastic bag or wrap to protect it from dampness.
3. Place the probe into the box and stabilize it with light packing material.
4. Seal the carton with shipping tape.

Replaceable Parts

The A621 is shipped with the following item(s):

- these instructions
Tektronix part number 070-8882-01

The following accessories are recommended:

- a BNC-to-banana plug adapter (for use with DMM's)
Tektronix part number 012-1450-00

The A621 does not have any user replaceable parts. If you should have trouble with your probe, contact your local Tektronix Service Center or representative for help.



北京海洋兴业科技股份有限公司

北京市西三旗东黄平路 19 号龙旗广场 4 号楼(E座)906 室

电 话: 010-62176775 62178811 62176785

企业 QQ: 800057747

企业官网: www.hyxyyq.com

邮编: 100096

传真: 010-62176619

邮箱: info.oi@oitek.com.cn

购线网: www.gooxian.net



扫描二维码关注我们
查找微信企业号: 海洋仪器