



致力于电子测试、维护领域!

DC POWER SUPPLY

GPR-HIGH SERIES
(ANALOG/DIGITAL TYPE)

USER MANUAL

GW INSTEK PART NO.82PR-30H10MD



CONTENTS

SECTION	PAGE
1. INTRODUCTION	1
2. SPECIFICATIONS	2
2-1 General	2
2-2 Constant Voltage Operation	3
2-3 Constant Current Operation	3
2-4 Indicator Meter	3
2-5 Insulation	4
3. THEORY OF OPERATION	4
3-1 Low Voltage Circuit	4
3-2 High Voltage Circuit	5
4. PANEL CONTROLS AND INDICATORS	8
4-1 Front Panel	8
4-2 Rear Panel	8
5. OPERATION INSTRUCTIONS	12
5-1 Precaution	12
5-2 Setting Current Limit	12
5-3 Constant Voltage/Constant Current Characteristic	12
5-4 Operation Mode	13
6. MAINTANCE	15
6-1 Fuse Replacement	15
6-2 Line Voltage Conversion	15
6-3 Adjustments	15

PRECAUTION APPENDIX

The Selection of Output Test Lead and Feedback Test Lead:

For safety assurance, please select the adequate output test lead according to the following list:

UL (CSA) Model	Conductor				Maximum Conductive Resistor Ω/km	Permissible Current A(amp)
	Wire No. AWG	Component pc/mm	Cross Section Area (mm^2)	Outer Diameter mm		
1015 TEW (Twisted Wire)	24	11/0.16	0.22	0.64	88.6	7.64
	22	17/0.16	0.34	0.78	62.5	10.0
	20	21/0.18	0.53	0.95	39.5	13.1
	18	34/0.18	0.87	1.21	24.4	17.2
	16	26/0.254	1.32	1.53	15.6	22.6
	14	41/0.254	2.08	2.03	9.90	30.4
	12	65/0.254	3.29	2.35	6.24	40.6
	10	65/0.32	5.23	3.00	3.90	55.3

Remark:

1. The ambient temperature of "Permissible Current" is at 40°C, the withstanding temperature of conductor is at 105°C according to the condition of the distributed single wire.
2. The permissible current listed as above is suggested to be used under 70%.
3. If the feedback test leads are in need, the level above UL(CSA) AWG24, 22, 20... can be accepted. Besides, when the load is a capacitive load, please use the twine wire by twisting (+)output test lead with (S+) feedback test lead. Same way used on (-) output test lead and (S-) feedback test lead.
4. When the current value exceeds above suggestive list, can select more wires used in parallel according to above list.

1. INTRODUCTION

The regulated DC power supply have been designed to provide the most often required in the laboratory, schools and production lines.

The output voltage is continuously adjustable between 0 to rating voltage in one range by means of a coarse and fine potentimeter, the load current may have any value from 0 to rating current and adjusted by means of a coarse and fine potentimeter. Both outputs can accurately read on voltmeter and ammeter.

Both stability and ripple are extremely good to meet the requirements of modern circuit design. The unit can be used as either constant voltage or current source. The various operation mode are described in more detail in the Operation Instruction section.

For applications when outputs greater than rating V is need, the unit can be connected up in series.

For applications in audio production lines, the continuous or dynamic load internal selectable.

2. SPECIFICATIONS

2-1 General

Main supply

100V/120V/220V/240V \pm 10 % 50/60 Hz (Switch selectable)

Rating, dimension and weight

see Table 2-1.

Table 2-1

MODEL	Max. Rating		Dimensions	Weight
	Volts (V)	Amps (A)	WxHxD (m/m)	Kg
GPR-30H10	300	1	225 (W) 145 (H) 420 (D)	13.5
GPR-11H30	110	3		13.5
GPR-7550	75	5		18.5
GPR-6060	60	6		18.5
GPR-3510H	35	10		18.5
GPR-1820H	18	20		18.5
GPR-0830H	8	30		18.5

(NOTE: All model with digital display available.)

Operation mode

Operation Temperature & Humidity

Storage Temperature & Humidity

Accessories

Series Operation

0°C to 40°C, <80%

-10°C to 70°C, <70%

Test Lead GTL-105 (current <4A)x1
or GTL-104 (4≤current≤10A)

Notes: Current > 10A without Test Lead.

Operation Manualx1

2-2 Constant Voltage Operation

- (1) Output voltage ranges 0 to rating voltage continuously adjustable.
- (2) Voltage regulation
line regulation $\leq 0.01\% + 3\text{mV}$
load regulation $\leq 0.01\% + 5\text{mV}$
load regulation $\leq 0.02\% + 5\text{mV}$ ($\geq 10\text{A}$)
- (3) Recovery time $\leq 100\mu\text{s}$ (50% Load change, Minimum load 0.5A)
- (4) Ripple & Noise $\leq 1\text{mV rms}$ (5Hz~1MHz)
- (5) Temperature coefficient $\leq 300\text{PPM}/^\circ\text{C}$

2-3 Constant Current Operation

- (1) Output current range 0 to rating current continuously adjustable.
- (2) Current regulation
line regulation $\leq 0.2\% + 3\text{mA}$
load regulation $\leq 0.2\% + 5\text{mA}$
- (3) Ripple current $\leq 5\text{mA rms}$ ($\leq 20\text{A}$), $\leq 10\text{mA rms}$ ($\leq 30\text{A}$),
 $\leq 20\text{mA rms}$ ($\leq 50\text{A}$)

2-4 Indicator Meter

- (1) Digital Type
Display: 3½ Digits 0.5" Red LED Display.
Accuracy: $\pm(0.5\%$ of rdg + 2 digits)
Voltage range: 19.99V of full scale (rating voltage $\leq 18\text{V}$).
199.9V of full scale (rating voltage $\leq 180\text{V}$).
1999V of full scale (rating voltage $\leq 1800\text{V}$)
Current range: 1.999A of full scale (rating current $\leq 1.8\text{A}$)
19.99A of full scale (rating current $\leq 18\text{A}$)
199.9A of full scale (rating current $\leq 180\text{A}$).
- (2) Analog Type
Meter: Voltmeter and Ammeter each one
Class: 2.5
Dimensions: 60x80 mm

2-5 Insulation

Between chassis and output terminal

100M Ω or above (DC 1000V)

Between chassis and AC cord

100M Ω or above (DC 1000V)

3. THEORY OF OPERATION

3-1 Low Voltage Circuit (FIG. 1)

The power supply consists of an AC input circuit and transformer, a bias supply consisting of a rectifier and filter and reference voltage source, a main regulator circuit consisting of the main rectifier and filter, a series regulator, a current comparator, a voltage comparator, a reference voltage amplifier, tag a instant over load protection circuit and a relay control circuit.

The circuit element are several of integrated circuit (U201, U202, U203, U204, U101, U205).

The circuit is discussed with reference to the block diagram Function Description.

Single phase input power is applied to transformer through the input circuit.

Auxiliary rectifier D101-D104 provides a bias voltage filtered by capacitor C101, C102 for the preregulator U101, Q101, Q102, that provides a regulator voltage for element of action.

The main rectifier, a full wave bridge rectifier, provides the power which is filtered by capacitor C401~C404 and then regulated via a series regulator and deliver to the output.

U204 provides a reference voltage for U205, U205 acted as a current limiter. When current is over predominate rating, it acted and decreased the current. U201 provides a reference voltage for U202, U202 is a inverter amplifier, U205 is a comparator amplifier. It's many be made comparator for reference voltage and detector feedback voltage, and then deliver to Q203 this time output voltage is calibrated.

Q201 is instant over load protection circuit Q201 turn on when voice response load adds at instant. It controls Q203 current magnitude of I_B makes output current limited.

The relay control circuit provides limited power dissipation in series regulator.

3-2 High Voltage Circuit (FIG. 2)

The power supply consists of an AC input circuit and transformer, a bias supply consisting of a rectifier and filter and reference voltage source, a main rectifier circuit consisting of the main rectifier and filter, a series regulator, a current comparator, a voltage comparator, a reference voltage amplifier, and a transistor driver consisting of rectifier and filter.

The circuit element are several of integrated circuit (U201, U202, U203, U204, U101, U205).

The circuit is discussed with reference to the block diagram Function Description.

Single phase input power is applied to transformer through the input circuit.

Auxiliary rectifier D101-D104 provides a bias voltage filtered by capacitor C101, C102 for the preregulator U101, Q101, Q102, that provides a regulator voltage for element of action.

The bias voltage is provide by auxiliary rectifier (D302~D305) to turn the transistor (Q303~Qn) ON.

The main rectifier is make by rectifiers and filters and then regulated via a series regulator and deliver to the output.

U204 provides a reference voltage for U205, U205 acted as a current limter. When current is over predominate rating, it acted and decreased the current. U201 provides a reference voltage for U202, U202 is a inverter amplifier, U205 is a comparator amplifier. It's may be made comparator for reference voltage and detector feedback voltage, and then deliver to Q202, Q203, this time output voltage is calibrated.

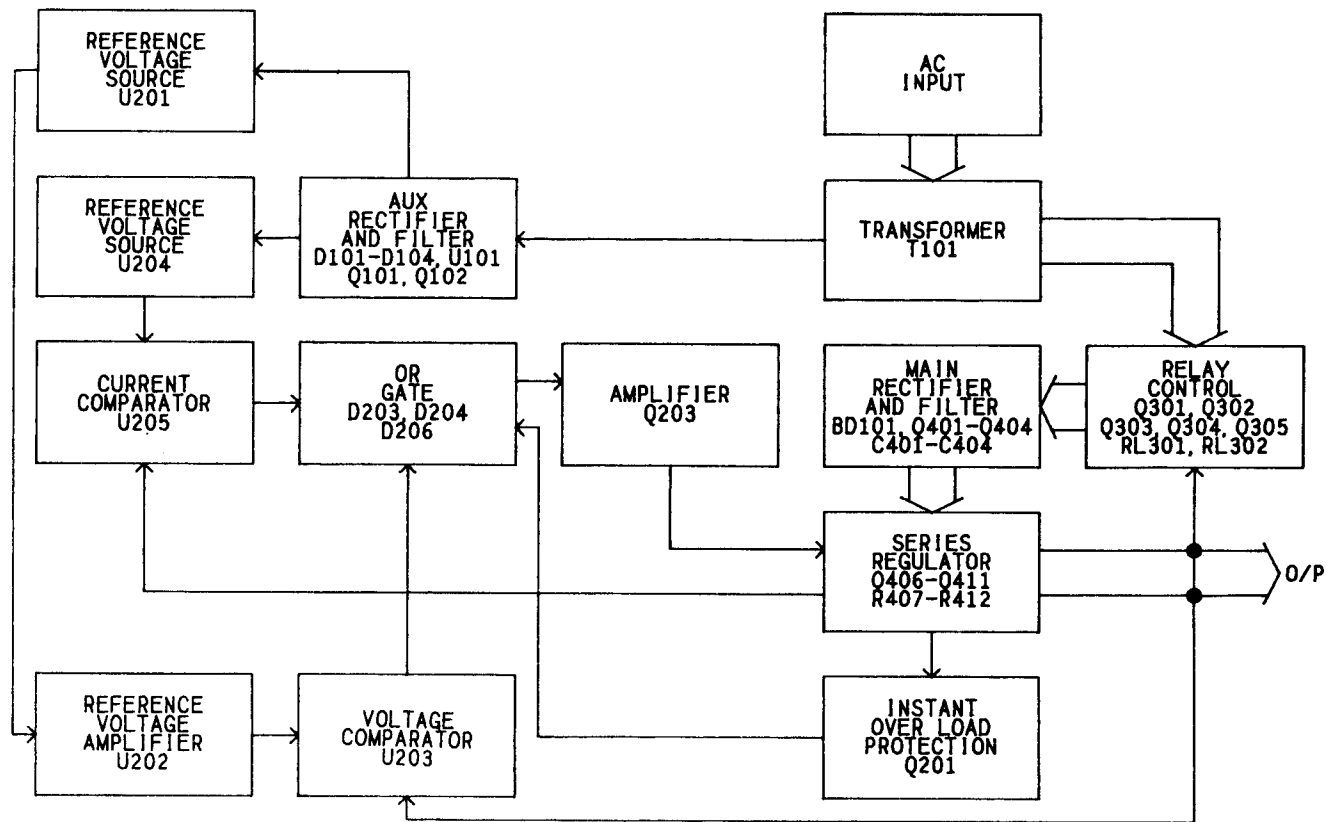

Fig. 1 Block Diagram (Less than 100V)

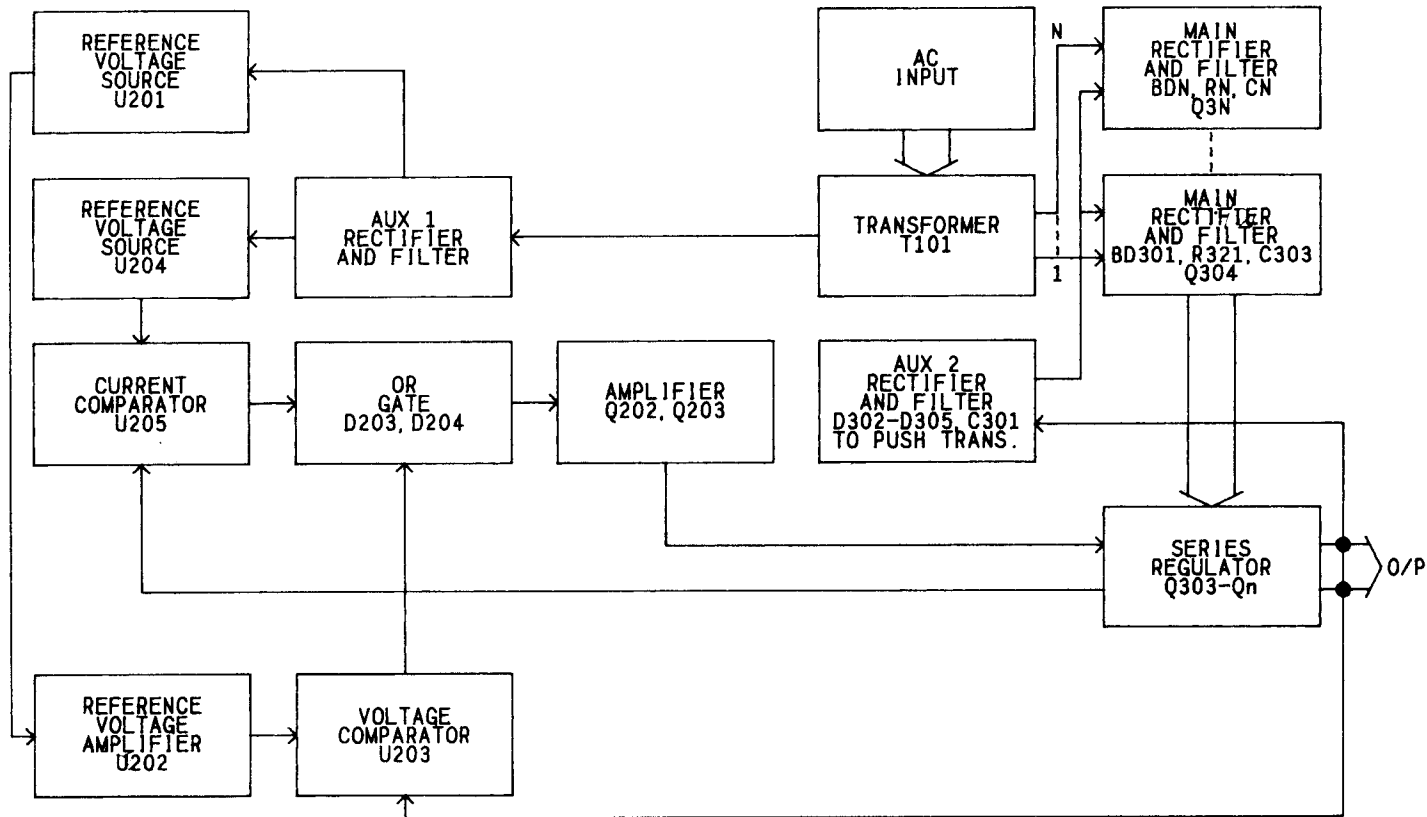

Fig. 2 Block Diagram (More than 100V)

4. PANEL CONTROLS AND INDICATORS

4-1 Front panel (FIG. 4-1, 4-2)

- | | | |
|---|---------------------|--|
| ① | CV indicator | lights when the power turn on and constant voltage operation. |
| ② | CC indicator | lights when this unit in constant current operation. |
| ③ | Voltage coarse | for the coarse adjustment of the output voltage. |
| ④ | Voltage fine | for the fine adjustment of the output voltage. |
| ⑤ | Current coarse | for the coarse adjustment of the output current. |
| ⑥ | Current fine | for the fine adjustment of the output current. |
| ⑦ | "+" output terminal | positive polarity. (Red) |
| ⑧ | GND terminal | Earth and chassis ground (green). |
| ⑨ | "-" output terminal | negative polarity. (Black) |
| ⑩ | Voltmeter | indicates the output voltage (Digital panel meter or Analog meter) |
| ⑪ | Ammeter | indicates the output current (Digital panel meter or analog meter) |
| ⑫ | Power control | on/off switch. |

4-2 Rear panel (FIG. 4-3)

- | | | |
|---|-------------------|---|
| ⑬ | Fuse holder | |
| ⑭ | Power socket | |
| ⑮ | HI-LO switch | HI, position selects high voltage range (120V, 240V AC inputs), LO position selects low voltage range (100V, 220V AC inputs). |
| ⑯ | AC selects switch | With ⑮ HI-LO switch selects to permit operation from 100, 120, 220 or 240VAC, 50/60HZ line voltage. |
| ⑰ | Cooling FAN | Ventilates the hot air out, to prevent output stage from thermo shock, and also improves the temperature coefficient. |
| ⑱ | "S+" terminal | Positive polarity sense terminal. |
| ⑲ | "+" terminal | Positive polarity output terminal. |
| ⑳ | "-" terminal | Negative polarity output terminal. |
| ㉑ | "S-" terminal | Negative polarity sense terminal. |
| ㉒ | GND terminal | Earth and chassis ground. |

NOTE: If the load current is great than "10A", then the "18"~"22" terminal is used, and the output is connected from the rear panel.

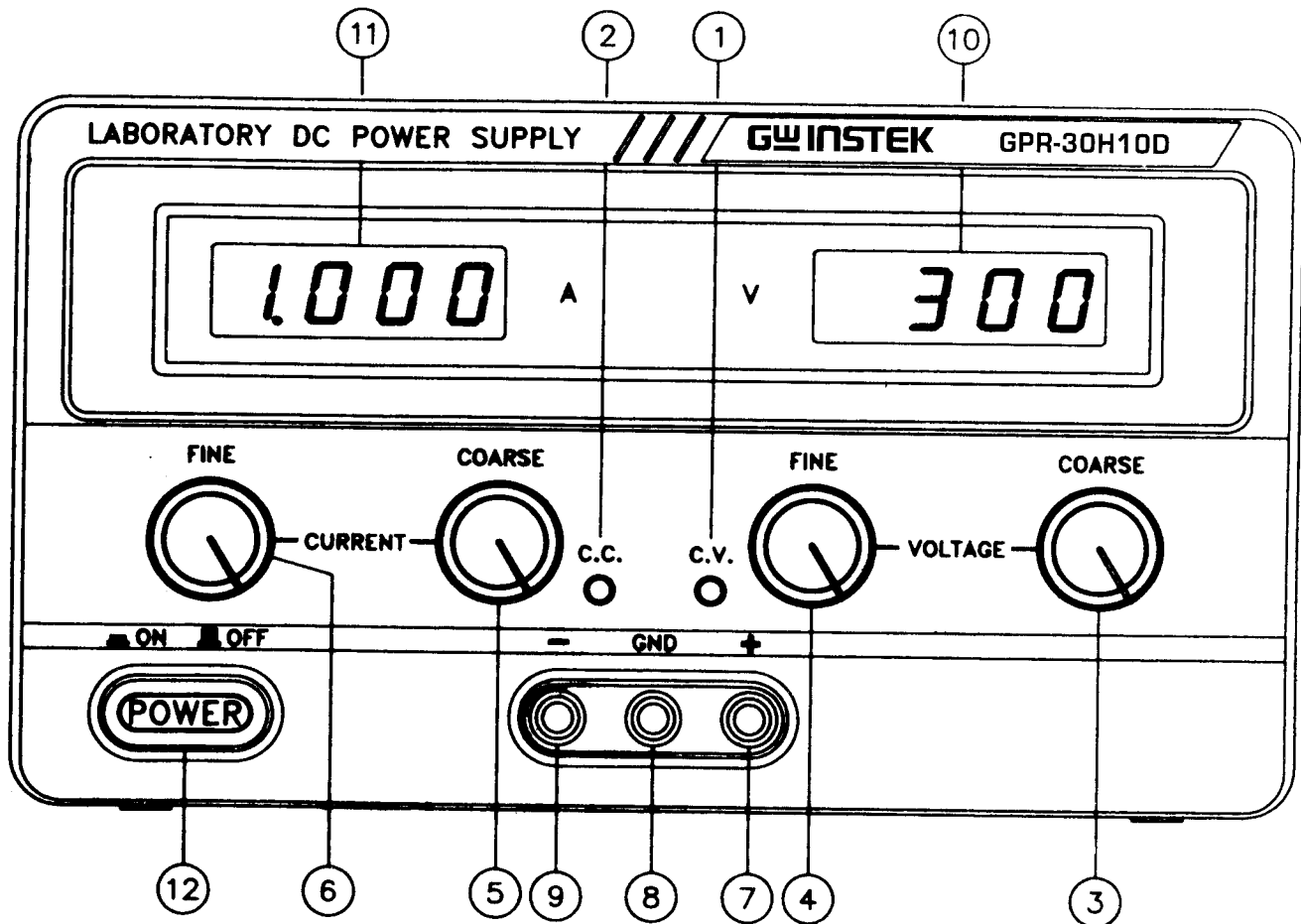

Fig. 4-1 Front Panel (Digital Type)

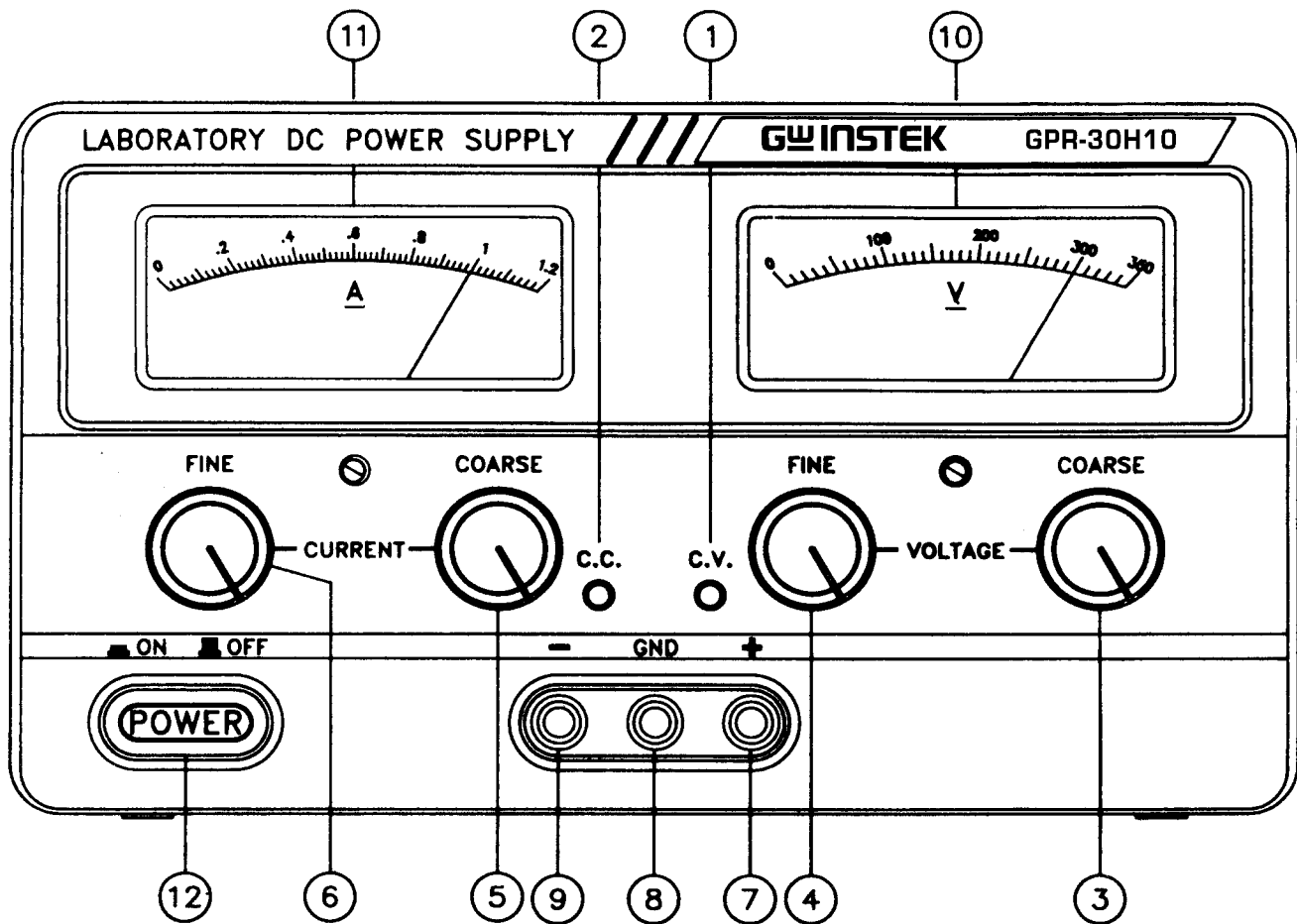

Fig. 4-2 Front Panel (Analog Type)

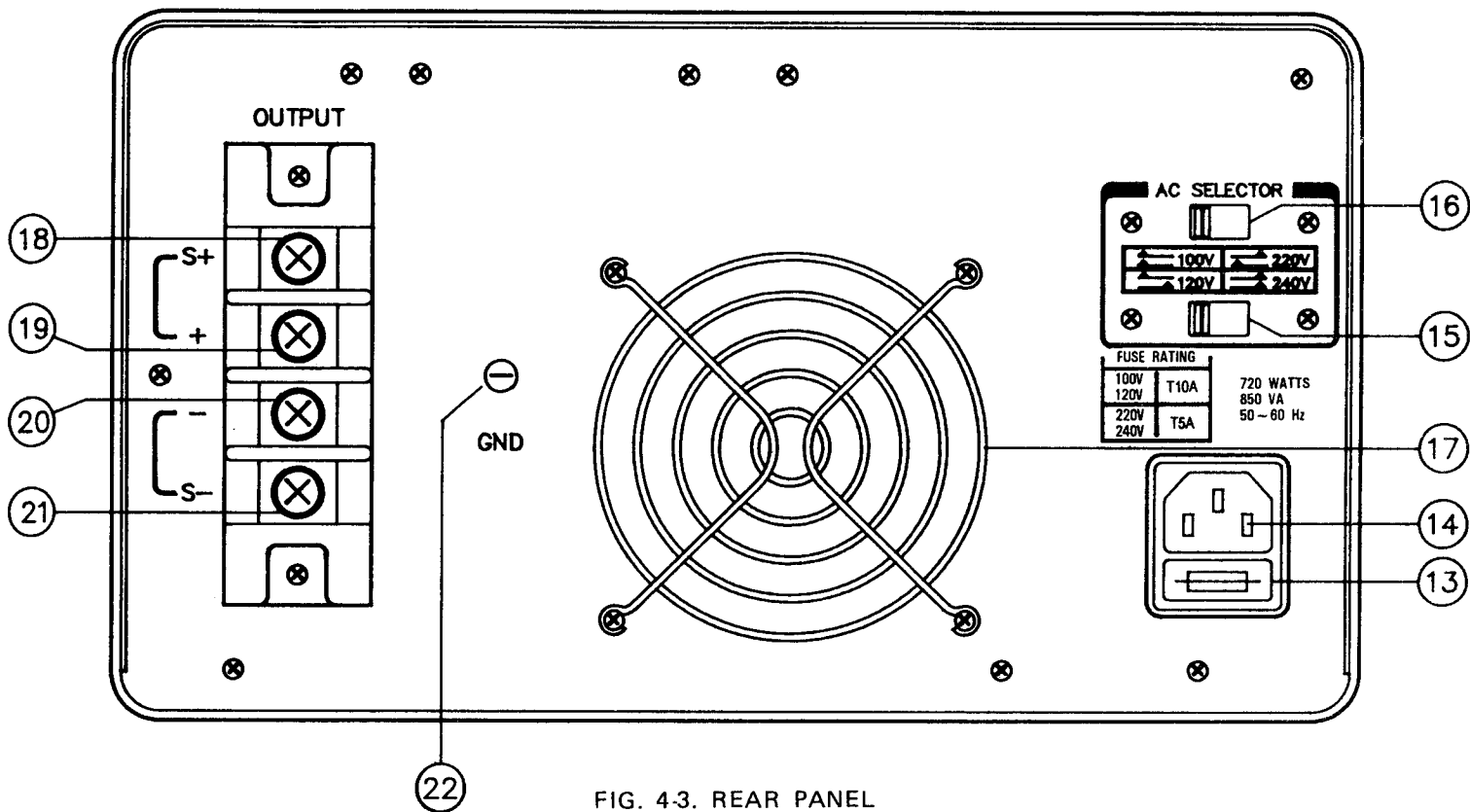

FIG. 4-3. REAR PANEL

5. OPERATION INSTRUCTIONS

5-1 Precaution

- (1) AC input
AC input should be within the range of line voltage $\pm 10\%$ 50/60Hz.
- (2) Installation
Avoid using the supply in a place where the ambient temperature exceeds 40°C. The heat sink located at the rear of the supply must have sufficient air space for radiation.
- (3) Output voltage overshoot
Voltage between output terminals never exceeds the preset value when the power is turned on or off.

5-2 Setting Current Limit

- (1) Determine the maximum safe current for the device to be powered.
- (2) Temporarily short the (+) and (-) terminals of the power supply together with a test lead.
- (3) Rotate the COARSE VOLTAGE control away from zero sufficiently for the CC indicator to light.
- (4) Adjust the CURRENT control for the desired current limit. Read the current value on the Ammeter.
- (5) The current limit (overload protection) has now been preset. Do not change the CURRENT control setting after this step.
- (6) Remove the short between the (+) and (-) terminals and hook up for constant voltage operation.

5-3 Constant Voltage/Constant Current Characteristic

The working characteristic of this series Power Supplies is called a constant voltage/constant current automatic cross-over type. This permits continuous transition from constant current to constant voltage modes in response to the load change. The intersection of constant voltage and constant current modes is called the crossover point. Fig. 5-1 shows the relationship between this crossover point and the load.

For example, if the load is such that the power supply is operating in the constant voltage mode, a regulated output voltage is provided. The output voltage remains constant as the load increases, up until the point where the preset current limit is reached. At that point, the output current becomes constant and the output voltage drops in proportion to further

increases in load. The crossover point is indicated by the front panel LED indicators. The crossover point is reached when the CV indicator goes off and the CC indicator comes on.

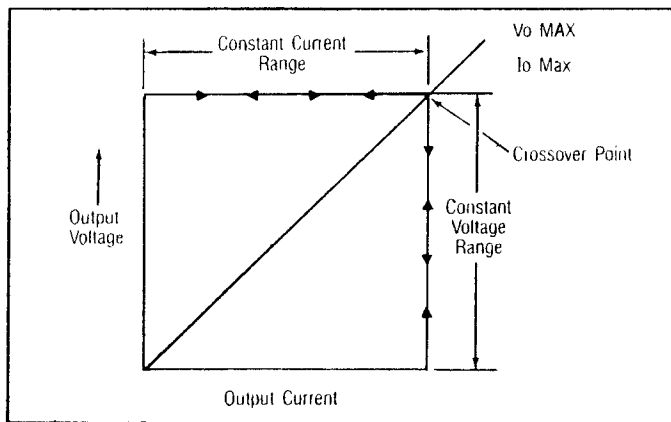

Fig. 5-1 Constant Voltage/Constant Current Characteristic.

Similarly, crossover from the constant current to the constant voltage mode automatically occurs from a decrease in load. A good example of this would be seen when charging a 12 Volts battery. Initially, the open circuit voltage of the power supply may be preset for 13.8 volts. A low battery will place a heavy load on the supply and it will operate in the constant current mode, which may be adjusted for a 1 amp charging rate. As the battery becomes charged, and its voltage approaches 13.8 volts, its load decreases to the point where it no longer demands the full 1 amp charging rate. This is the crossover point where the power supply goes into the constant voltage mode.

5-4 Operation Mode

(1) Single Operation

Use the supply as it is for single operation.

- A. Set Power switch to "OFF" position.
- B. Make sure that line voltage is correct for the input power voltage.
- C. Plug power cord into the power outlet.
- D. Set Power switch to "ON" position.
- E. Adjust "Voltage" and "Current" control to the desired output voltage and current.
- F. Connect the external load to the output binding posts. Make sure both "+" and "-" terminals are connected correctly.

(2) Series Operation

Two power supplies may be connected in series to provide higher voltage and rating current output. See Fig. 5-2 for the connection scheme.

When connected in series, the VOLTAGE controls of each power supply exercise control over a 0 to rating range. Add the two voltmeter readings together to determine the total output voltage, or an external voltmeter may be connected across the load.

Load current may be monitored from either supply; the readings will be identical since they are connected in series. Also, since the supplies are connected in series, it is only necessary to set the current limit on one of the supplies; the other may be set for maximum.

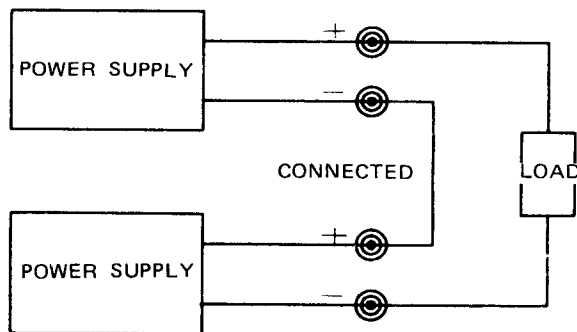

Fig. 5-2 Connecting Two Power Supplies in Series.

6. MAINTENANCE

WARNING

The following instructions are for use by qualified personnel only. To avoid electrical shock, do not perform any servicing other than contained in the operating instructions unless you are qualified to do so.

6-1 Fuse Replacement

If the fuse blows, the CV or CC indicators will not light and the power supply will not operate. The fuse should not normally open unless a problem has developed in the unit. Try to determine and correct the cause of the blown fuse, then replace only with a fuse of the correct rating and type.

The fuse is located on the rear panel (see Fig. 4-3).

6-2 Line Voltage Conversion

The primary winding of the power transformer is tapped to permit operation from 100, 120, 220, or 240 VAC, 50/60 Hz line voltage. Conversion from one line voltage to another is done by change AC selects switch as shown in Fig. 4-3.

The rear panel identifies the line voltage to which the unit was factory setted. To convert to a different line voltage, perform the following procedure:

- (1) Make sure the power cord is unplugged.
- (2) Change the AC selects switch to the desired line voltage position.
- (3) A change in line voltage may also require a corresponding change of fuse value. Install the correct fuse value as listed on rear panel.

6-3 Adjustments

This unit was accurately adjusted at the factory before shipment. Readjustment is recommended only if repairs have been made in a circuit affecting adjustment accuracy, or if you have a reason to believe the unit is out of adjustment. However, adjustments should be attempted only if a multimeter with an accuracy of $\pm 0.1\%$ dcv or better is available (GOOD WILL Model GDM-8035G or equivalent).

6-3-1 Low Voltage Model (Less than 100V)

If readjustment is required, use the following procedure. Locations of the adjustments are shown in Fig. 6-1 and FIG. 6-2.

- (1) Adjustment of the Rating Voltage
 - A. Connect an accurate ($\pm 0.1\%$) external multimeter to measure the dc voltage at output terminals of the power supply.
 - B. Set the COARSE and FINE VOLTAGE controls to minimum (fully counterclockwise).
 - C. Adjust trimmer pot VR204 for a reading of 0 volts on the multimeter.
 - D. Turn the COARSE and FINE VOLTAGE controls to maximum (fully clockwise).
 - E. Adjust trimmer pot VR201 for a reading of rate volts $\times 1.05$ on the multimeter.
 - F. Set the COARSE and FINE VOLTAGE controls for a reading of rate volts on the multimeter.
 - G. Adjust trimmer pot VR209 (VR201 digital type) for a reading of rate volts on the volt meter (Digital Panel meter, digital type) of the power supply.
- (2) Adjustment of the Rating Current
 - A. Set the COARSE and FINE VOLTAGE controls to 5 Volts.
 - B. Set the COARSE and FINE CURRENT controls to minimum (fully counterclockwise).
 - C. Connect the external multimeter to measure dc current at the output terminals of the power supply.
 - D. Setting and turn the COARSE and FINE CURRENT controls to maximum (fully clockwise).
 - E. Adjust trimmer pot VR205 for a reading of rate amps $\times 1.05$ on the multimeter.
 - F. Readjust the CURRENT control for a reading of rate amps on the multimeter.
 - G. Adjust trimmer pot VR210 (VR202 digital type) to calibrate the Ammeter (Digital panel meter, digital type) of the power supply for the same reading as the multimeter.

6-3-2 High Voltage Model (More than 100V)

If readjustment is required, use the following procedure. Locations of the adjustments are shown in Fig. 6-1 and FIG. 6-3.

- (1) Adjustment of the Rating Voltage
 - A. Connect an accurate ($\pm 0.1\%$) external multimeter to measure the dc voltage at output terminals of the power supply.
 - B. Set the COARSE and FINE VOLTAGE controls to minimum (fully counterclockwise).
 - C. Adjust trimmer pot VR204 for a reading of 0 volts on the multimeter.
 - D. Turn the COARSE and FINE VOLTAGE controls to maximum (fully clockwise).
 - E. Adjust trimmer pot VR201 for a reading of rate volts $\times 1.05$ on the multimeter.
 - F. Set the COARSE and FINE VOLTAGE controls for a reading of rate volts on the multimeter.
 - G. Adjust trimmer pot VR208 (VR201 digital type) for a reading of rate volts on the volt meter (Digital Panel meter, digital type) of the power supply.
- (2) Adjustment of the Rating Current
 - A. Set the COARSE and FINE VOLTAGE controls to 5 Volts.
 - B. Set the COARSE and FINE CURRENT controls to minimum (fully counterclockwise).
 - C. Connect the external multimeter to measure dc current at the output terminals of the power supply.
 - D. Setting and turn the COARSE and FINE CURRENT controls to maximum (fully clockwise).
 - E. Adjust trimmer pot VR205 for rate amps $\times 1.05$ on the multimeter.
 - F. Readjust the CURRENT control for a reading of rate amps on the multimeter.
 - G. Adjust trimmer pot VR209 (VR202 digital type) to calibrate the Ammeter (Digital panel meter, digital type) of the power supply for the same reading as the multimeter.

NOTE: Be sure to wear rubber insulating gloves whenever operation this power supply in order to guard against electric shock hazards.

PM-514A
PM-514A-1

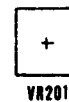
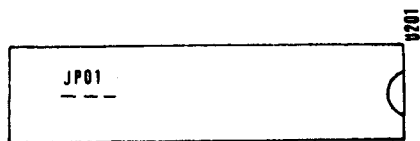

FIG. 6-1

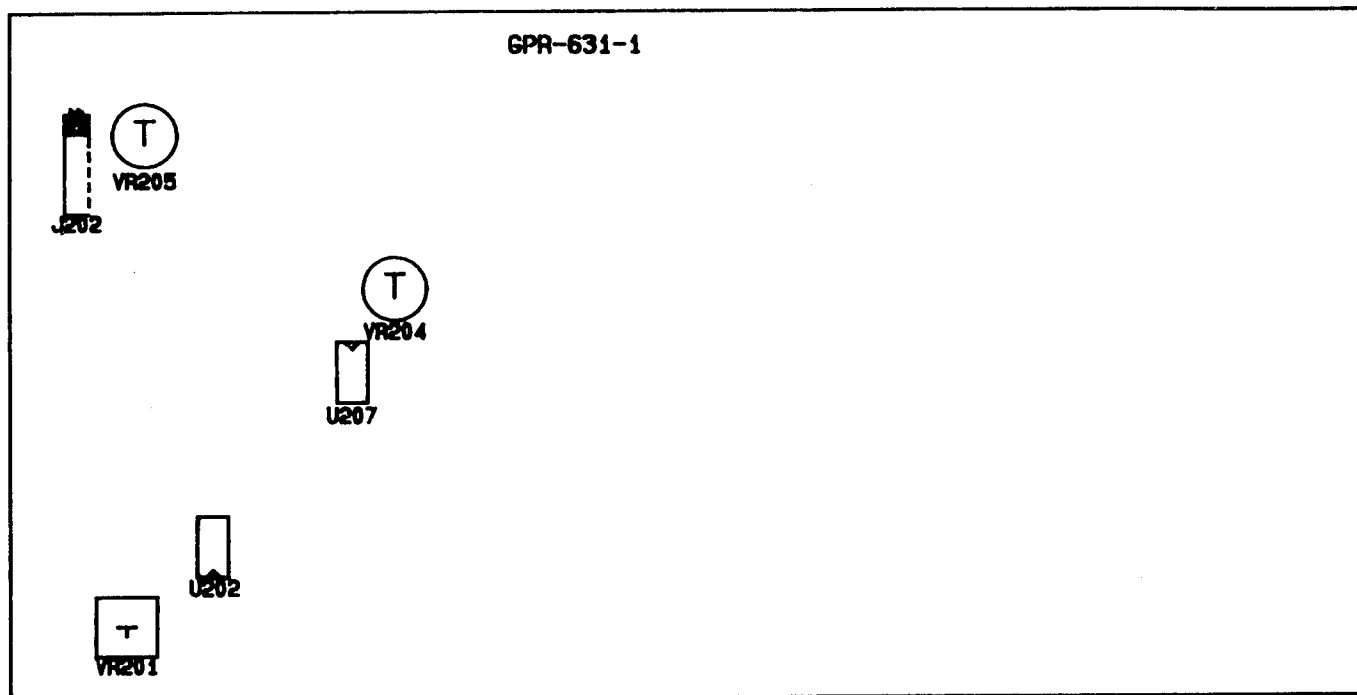
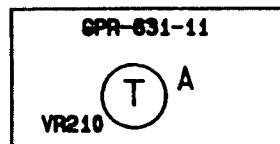
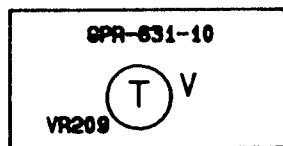

FIG. 6-2

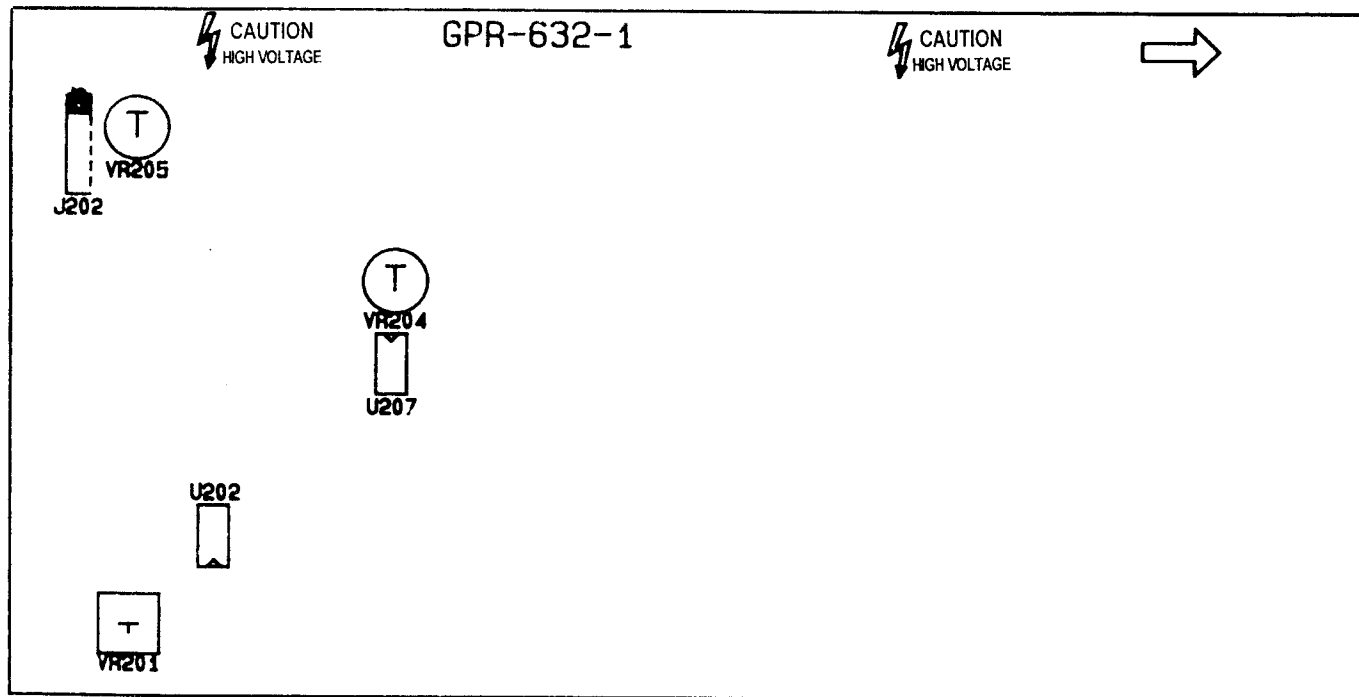
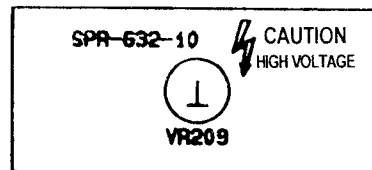
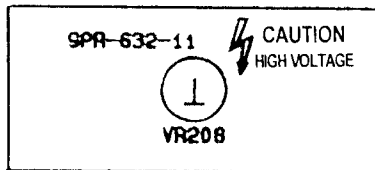

FIG. 6-3